

# ARTERY FORCEPS

# 14



PAGE 001 to 042



- EN Artery Forceps
- DE Arterienklemmen
- ES Pinzas hemostáticas

SERVING HEALTHCARE WORLDWIDE

[www.hilbro.net](http://www.hilbro.net)



Bulldog Clamps, Setting Forceps EN

Bulldogklemmen, Alegepinzetten DE

Clamps bulldog, pinzas para poner ES

# 14

## ARTERY FORCEPS



**DIEFFENBACH**

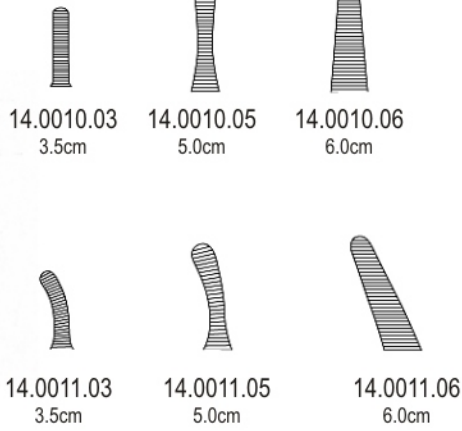

**JOHNS-HOPKINS**

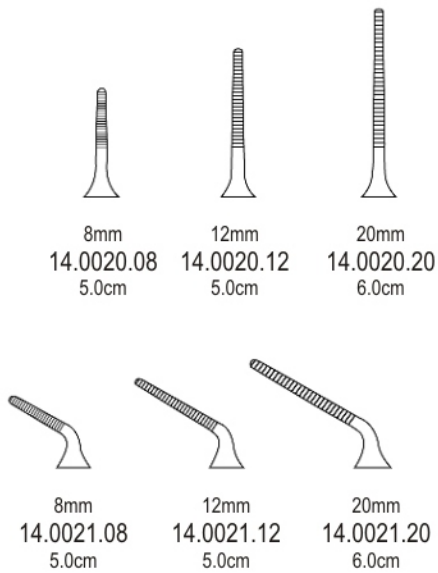
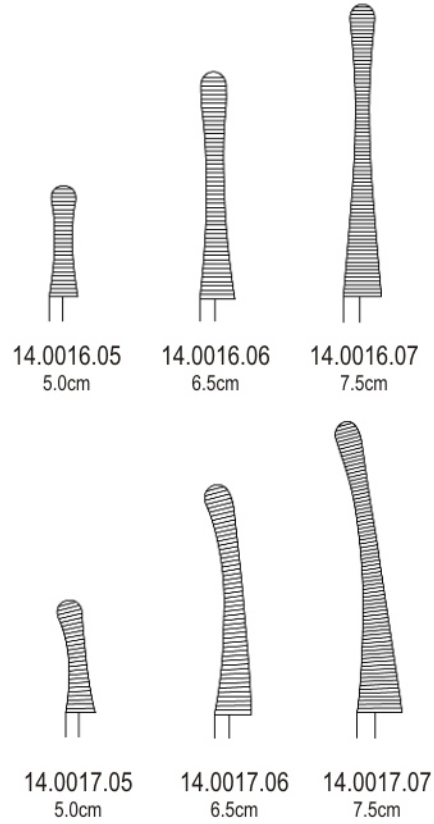

14.0026.14  
14.0cm



14.0028.18  
18.0cm

14.0028.18

**14-001**

[www.hilbro.net](http://www.hilbro.net)

EN Artery Forceps

DE Arterienklemmen

ES Pinzas hemostaticas



## ARTERY FORCEPS

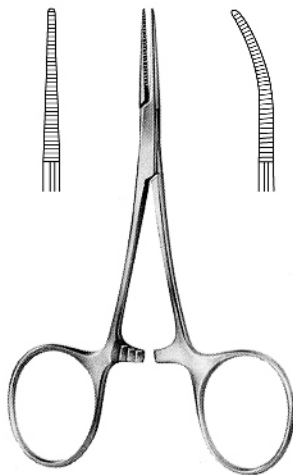

**HARTMANN**

14.0030.10 10.0cm 14.0031.10

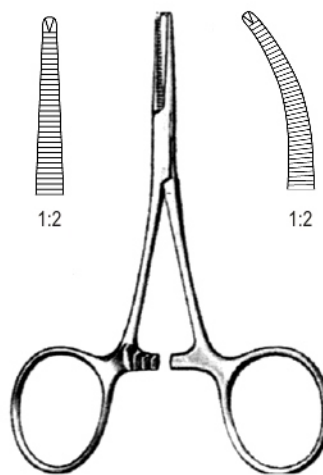

**HARTMANN**

14.0032.10 10.0cm 14.0033.10

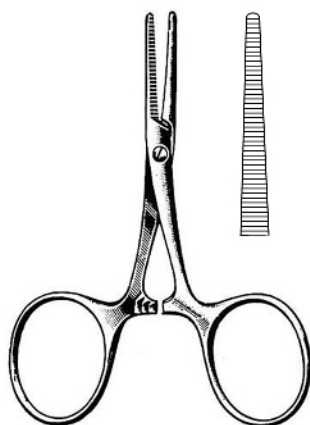

**CARREL**

14.0040.08 8.5cm

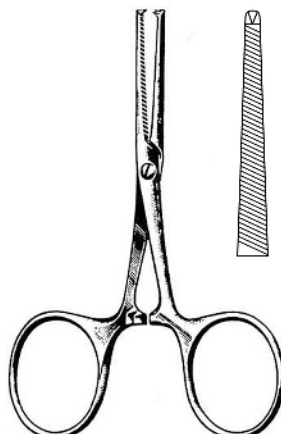

**TERRIER**

14.0044.08 8.5cm

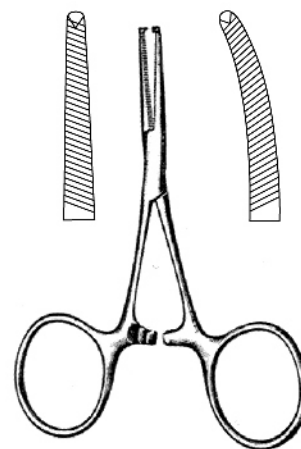

**TERRIER**

14.0048.09 9.0cm 14.0049.09

14.0049.09

**14-002**

www.hilbro.net

ARTERY FORCEPS

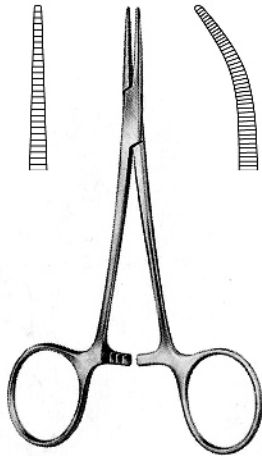

**HALSTED-MOSQUITO**

14.0060.12 12.5cm 14.0061.12  
14.0060.14 14.0cm 14.0061.14

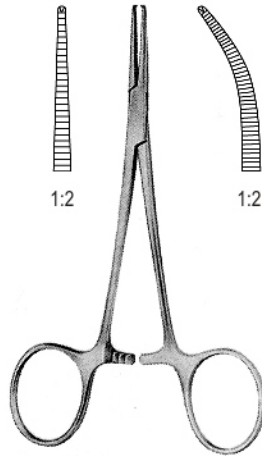

**HALSTED-MOSQUITO**

14.0062.12 12.5cm 14.0063.12  
14.0062.14 14.0cm 14.0063.14

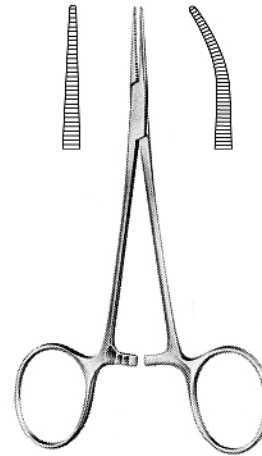

**MICRO-MOSQUITO**

14.0070.10 10.0cm 14.0071.10  
14.0070.12 12.0cm 14.0071.12  
14.0070.14 14.0cm 14.0071.14

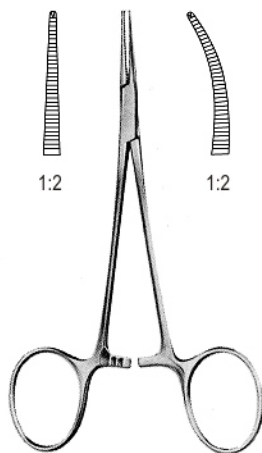

**MICRO-MOSQUITO**

14.0072.10 10.0cm 14.0073.10  
14.0072.12 12.0cm 14.0073.12  
14.0072.14 14.0cm 14.0073.14

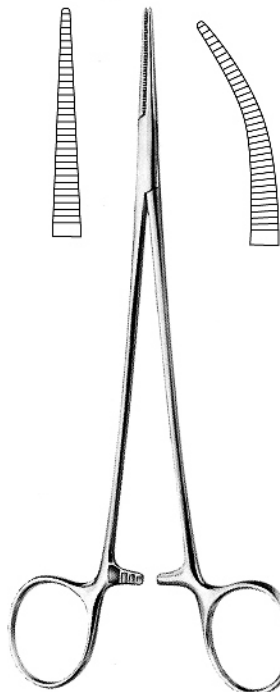

**HALSTED-MOSQUITO**

14.0080.16 16.0cm 14.0081.16  
14.0080.18 18.0cm 14.0081.18  
14.0080.21 21.0cm 14.0081.21

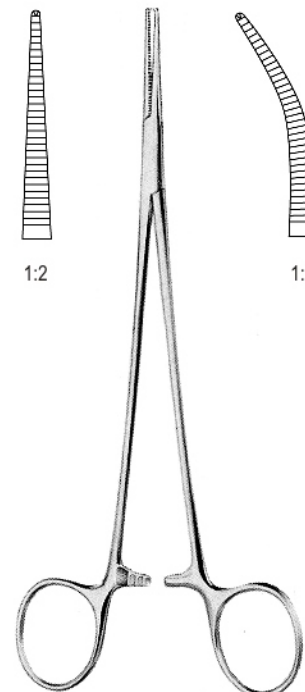

**HALSTED-MOSQUITO**

14.0082.16 16.0cm 14.0083.16  
14.0082.18 18.0cm 14.0083.18  
14.0082.21 21.0cm 14.0083.21

14.0083.21

**14-003**

www.hilbro.net

EN Artery Forceps

DE Arterienklemmen

ES Pinzas hemostaticas



## ARTERY FORCEPS

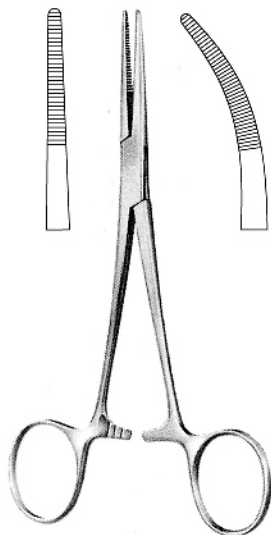

**KELLY**  
14.0090.14 14.0cm 14.0091.14

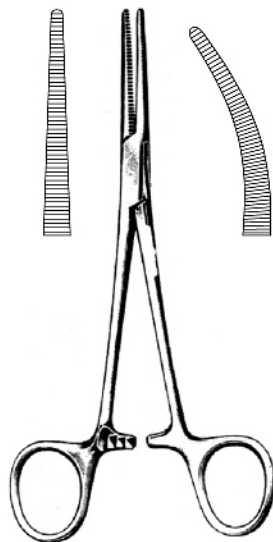

**CRILE**  
14.0094.14 14.0cm 14.0095.14

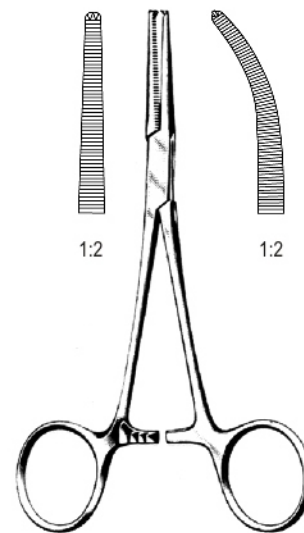

**CRILE**  
14.0096.14 14.0cm 14.0097.14

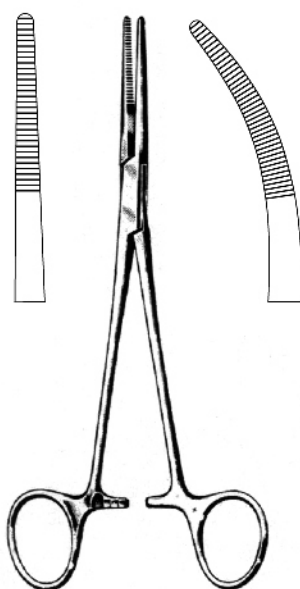

**RANKIN-KELLY**  
14.0100.16 16.0cm 14.0101.16

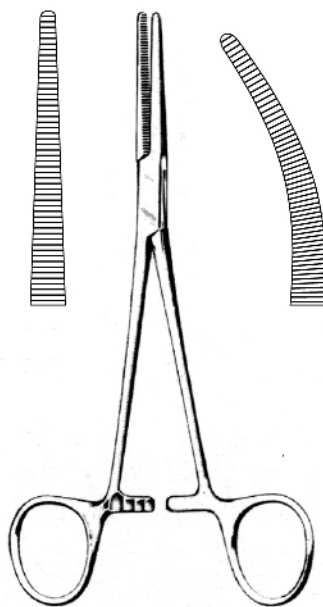

**RANKIN-CRILE**  
14.0104.16 16.0cm 14.0105.16

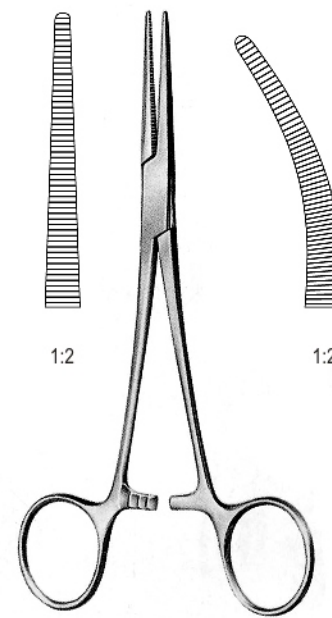

**CRILE-RANKIN**  
14.0106.16 16.0cm 14.0107.16

14.0107.16

**14-004**

www.hilbro.net

Artery Forceps EN

Arterienklemmen DE

Pinzas hemostaticas ES

14

ARTERY FORCEPS

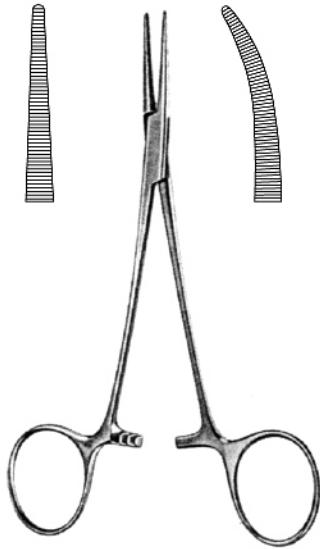

**CRILE-DELICATE**  
14.0110.14 14.0cm 14.0111.14

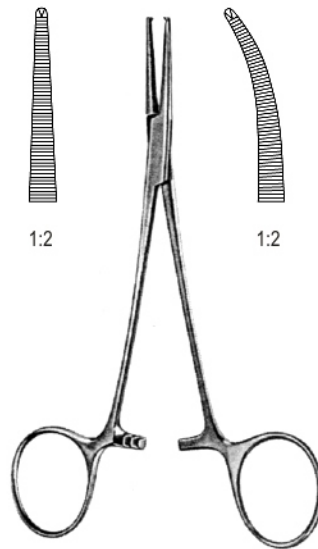

**CRILE-DELICATE**  
14.0116.14 14.0cm 14.0117.14

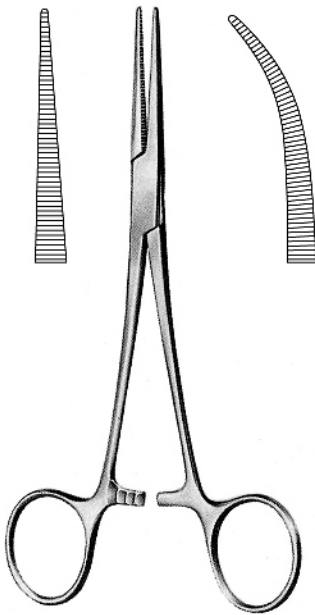

**COLLER-CRILE**  
14.0120.14 14.0cm 14.0121.14  
14.0120.16 16.0cm 14.0121.16

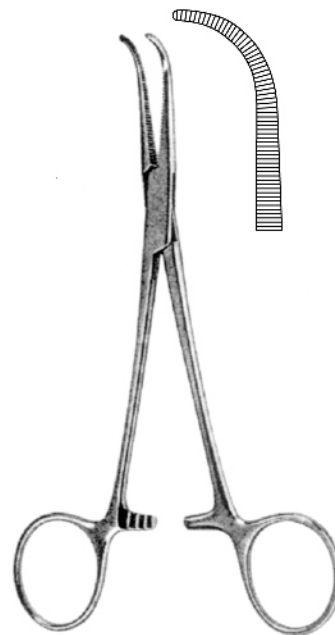

**COLLER-CRILE**  
14.0126.16 16.0cm

14.0126.16

**14-005**

[www.hilbro.net](http://www.hilbro.net)

EN Artery Forceps

DE Arterienklemmen

ES Pinzas hemostaticas



## ARTERY FORCEPS

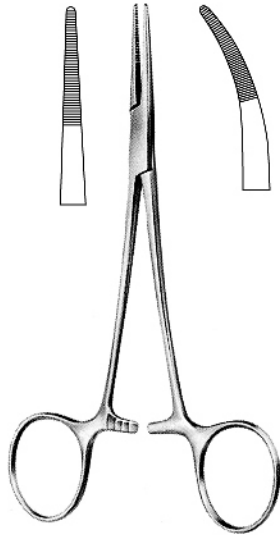

**PROVIDENCE-HOSPITAL**  
14.0130.14 14.0cm 14.0131.14

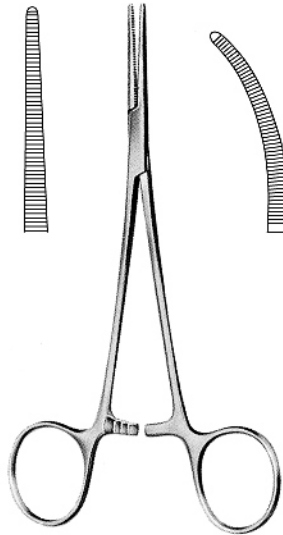

**LERICHE**  
14.0136.15 15.0cm 14.0137.15

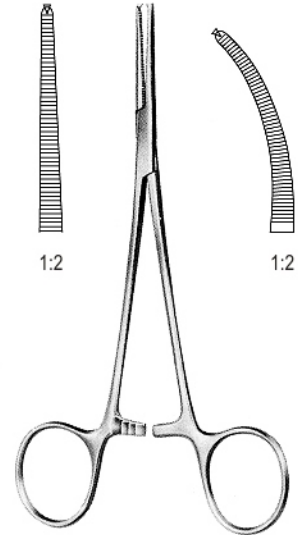

**LERICHE**  
14.0138.15 15.0cm 14.0139.15

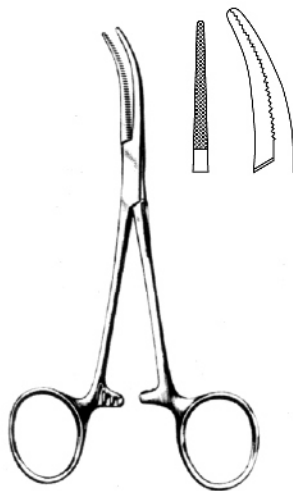

**BABY-DANDY**  
14.0140.12 12.0cm

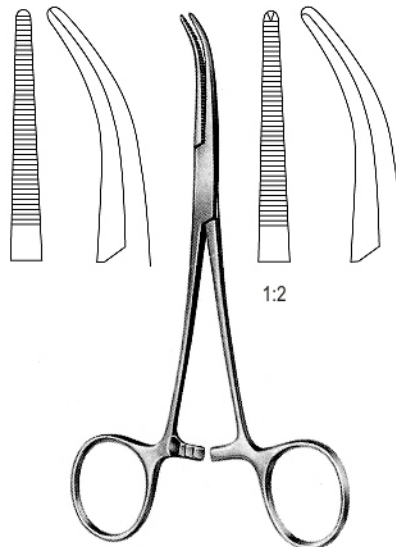

**DANDY**  
14.0142.14 14.0cm 14.0144.14

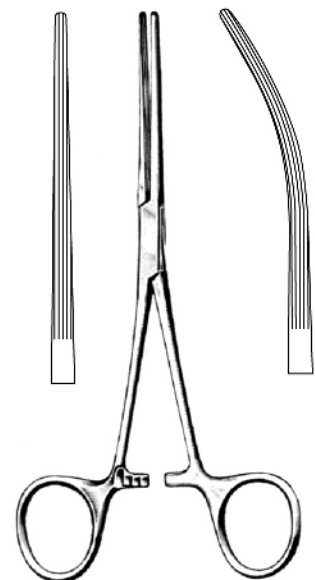

**BAINBRIDGE**  
14.0150.15 15.0cm 14.0151.15  
14.0150.18 18.5cm 14.0151.18

14.0151.18

**14-006**

www.hilbro.net

ARTERY FORCEPS

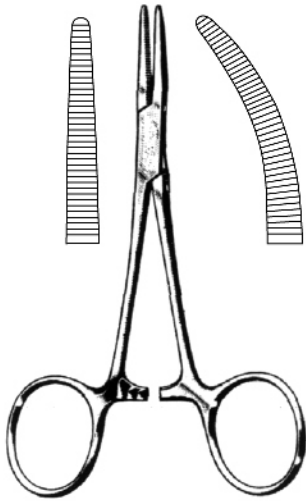

**JONES**

14.0156.12 12.5cm 14.0157.12  
14.0156.15 15.0cm 14.0157.15

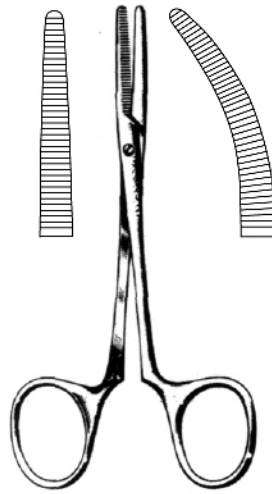

**SPENCER-WELLS**

14.0160.12 12.5cm 14.0161.12  
14.0160.15 15.0cm 14.0161.15  
14.0160.18 18.0cm 14.0161.18  
14.0160.20 20.0cm 14.0161.20  
14.0160.23 23.0cm 14.0161.23

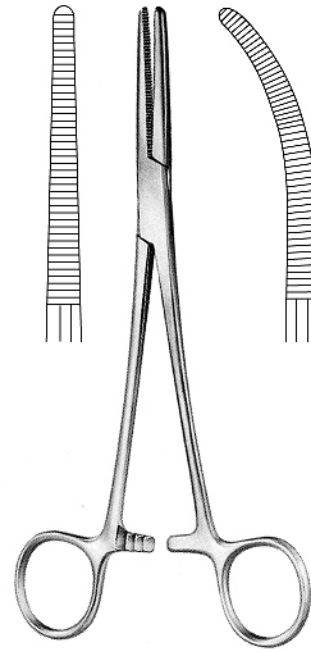

**SPENCER-WELLS**

14.0162.13 13.0cm 14.0163.13  
14.0162.14 14.0cm 14.0163.14  
14.0162.15 15.0cm 14.0163.15  
14.0162.18 18.0cm 14.0163.18  
14.0162.20 20.0cm 14.0163.20  
14.0162.23 23.0cm 14.0163.23

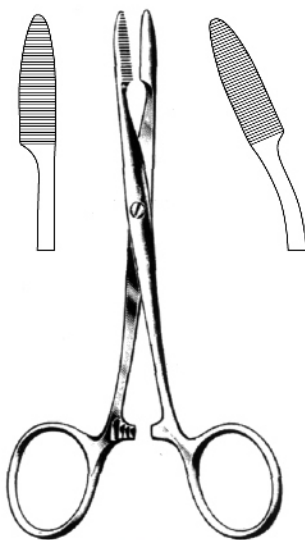

**PEAN**

14.0170.12 12.5cm 14.0171.12  
14.0170.14 14.0cm 14.0171.14  
14.0170.16 16.0cm 14.0171.16

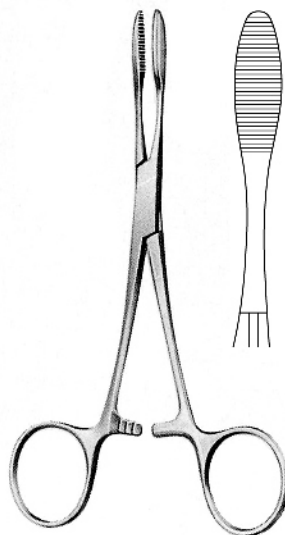

**PEAN**

14.0172.12 12.5cm  
14.0172.14 14.0cm  
14.0172.16 16.0cm

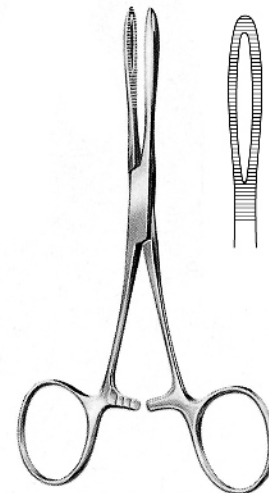

**KROENLIEN**

14.0176.14 14.0cm 14.0178.14

14.0178.14

**14-007**

www.hilbro.net



EN Artery Forceps

DE Arterienklemmen

ES Pinzas hemostaticas



## ARTERY FORCEPS

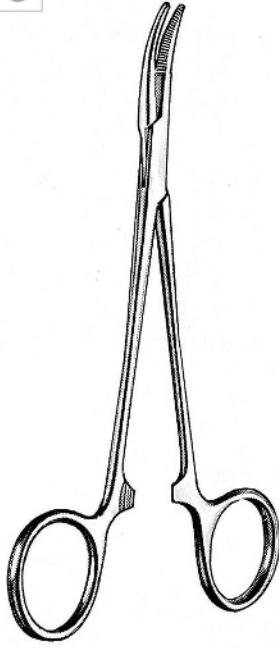

**CAIRNS**  
14.0180.14 14.5cm 14.0181.14

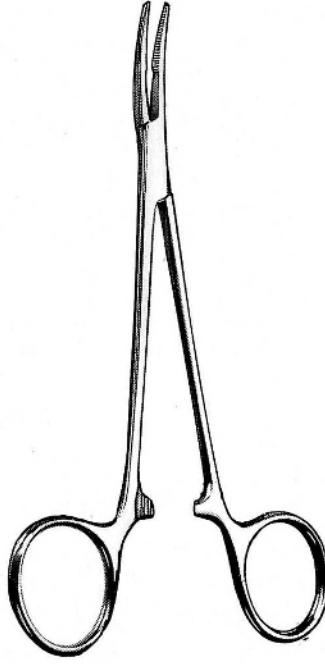

**CUSHING**  
14.0186.14 14.0cm 14.0187.14

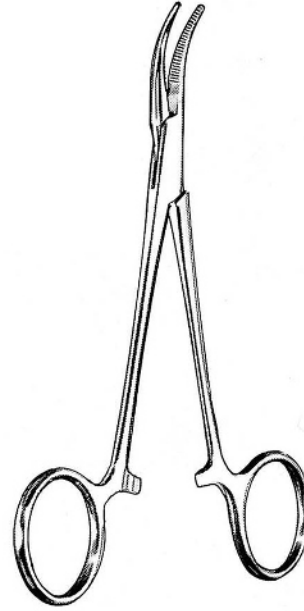

**KILNER**  
14.0190.14 14.0cm 14.0191.14

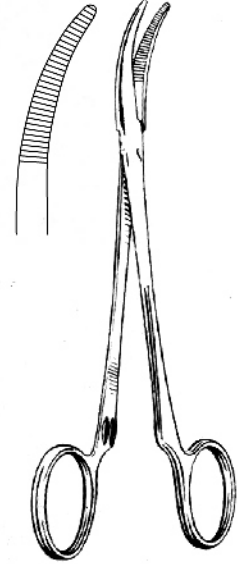

**KELLY**  
14.0196.12 12.5cm

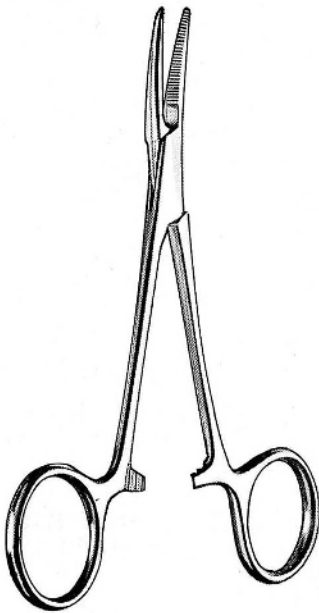

**DUNHILL**  
14.0200.12 12.5cm 14.0201.12

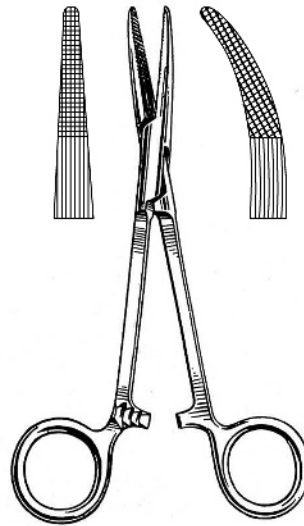

**GREY-TURNER**  
14.0206.15 15.0cm 14.0207.15

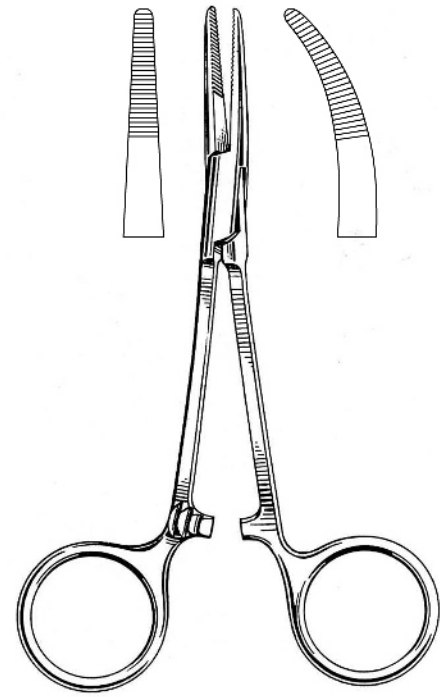

**MOYNIHAN**  
14.0210.14 14.5cm 14.0211.14

14.0211.14

**14-008**

[www.hilbro.net](http://www.hilbro.net)

Artery Forceps EN

Arterienklemmen DE

Pinzas hemostaticas ES

14

## ARTERY FORCEPS

Hilbro

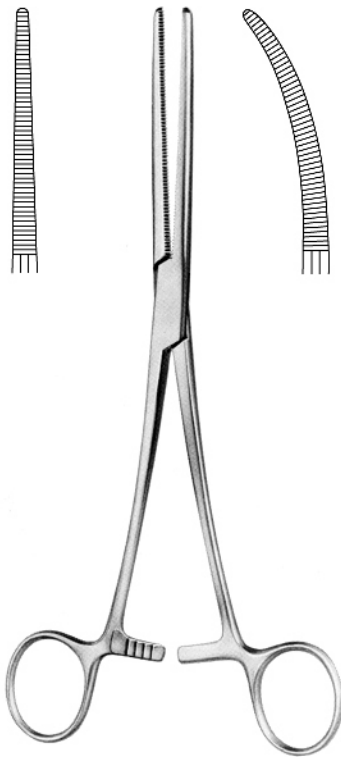

### PEAN (ROCHESTER)

14.0220.13	13.0cm	14.0221.13
14.0220.14	14.0cm	14.0221.14
14.0220.16	16.0cm	14.0221.16
14.0220.18	18.0cm	14.0221.18
14.0220.20	20.0cm	14.0221.20
14.0220.22	22.0cm	14.0221.22
14.0220.24	24.0cm	14.0221.24
14.0220.26	26.0cm	14.0221.26
14.0220.28	28.0cm	14.0221.28
14.0220.30	30.0cm	14.0221.30

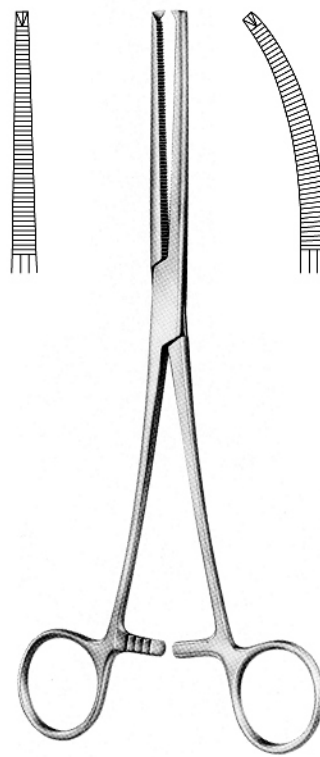

### KOCHER (OCHSNER)

14.0226.13	13.0cm	14.0227.13
14.0226.14	14.0cm	14.0227.14
14.0226.16	16.0cm	14.0227.16
14.0226.18	18.0cm	14.0227.18
14.0226.20	20.0cm	14.0227.20
14.0226.22	22.0cm	14.0227.22
14.0226.24	24.0cm	14.0227.24
14.0226.26	26.0cm	14.0227.26
14.0226.28	28.0cm	14.0227.28
14.0226.30	30.0cm	14.0227.30

14.0227.30

14-009

www.hilbro.net

EN Artery Forceps

DE Arterienklemmen

ES Pinzas hemostaticas



## ARTERY FORCEPS

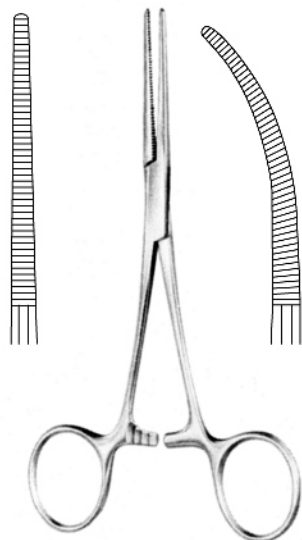

**PEAN (DELICATE)**

14.0230.13 13.0cm 14.0231.13  
 14.0230.14 14.0cm 14.0231.14  
 14.0230.16 16.0cm 14.0231.16

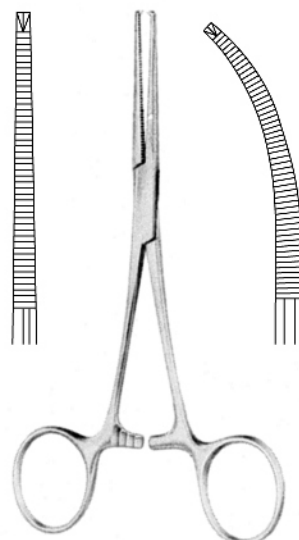

**KOCHER (DELICATE)**

14.0236.13 13.0cm 14.0237.13  
 14.0236.14 14.0cm 14.0237.14  
 14.0236.16 16.0cm 14.0237.16

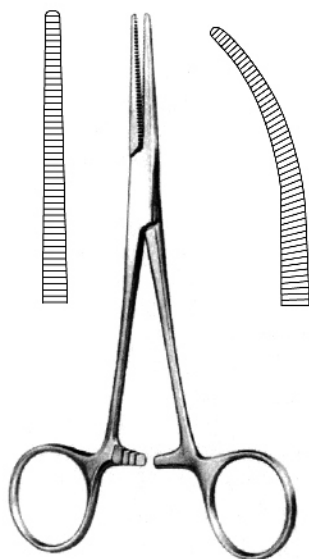

**PEAN-NIPPON**

14.0240.14 14.5cm 14.0241.14  
 14.0240.16 16.0cm 14.0241.16  
 14.0240.18 18.0cm 14.0241.18

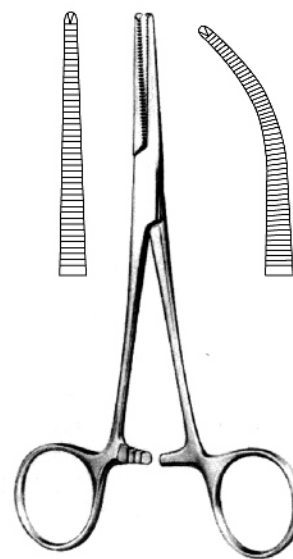

**KOCHER-NIPPON**

14.0246.14 14.5cm 14.0247.14  
 14.0246.16 16.0cm 14.0247.16  
 14.0246.18 18.0cm 14.0247.18

14.0247.18

**14-010**

www.hilbro.net

Artery Forceps EN

Arterienklemmen DE

Pinzas hemostaticas ES

# 14

## ARTERY FORCEPS

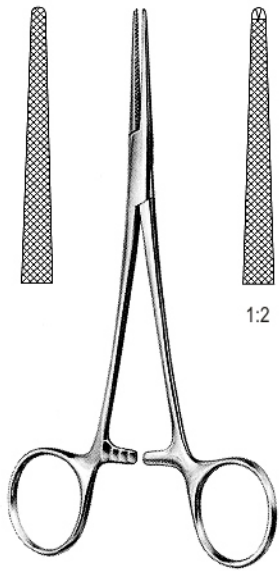

**LOVELACE**

14.0250.15 15.5cm 14.0252.15

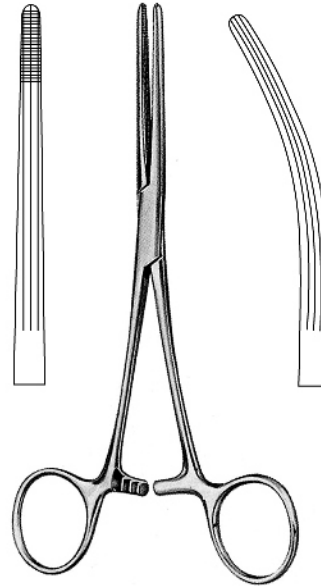

**ROCHESTER-CARMALT**

14.0256.16 16.0cm 14.0257.16  
14.0256.20 20.0cm 14.0257.20



**HOSEMANN**

14.0260.21 21.0cm 14.0262.21

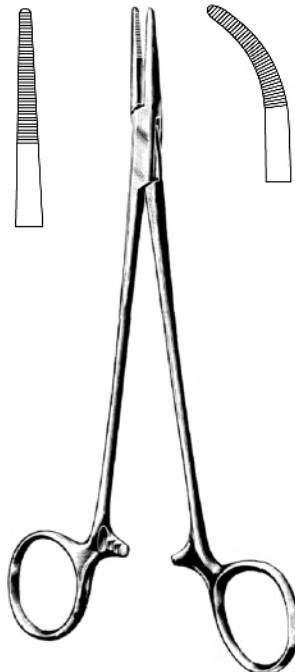

**ADSON**

14.0270.18 18.5cm 14.0271.18

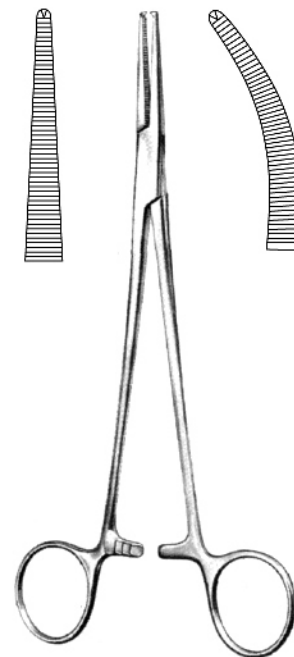

**ADSON**

14.0272.18 18.5cm 14.0273.18

14.0273.18

**14-011**

[www.hilbro.net](http://www.hilbro.net)

EN Artery Forceps

DE Arterienklemmen

ES Pinzas hemostaticas



## ARTERY FORCEPS

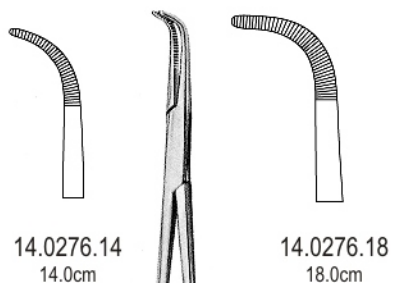

14.0276.14  
14.0cm

14.0276.18  
18.0cm

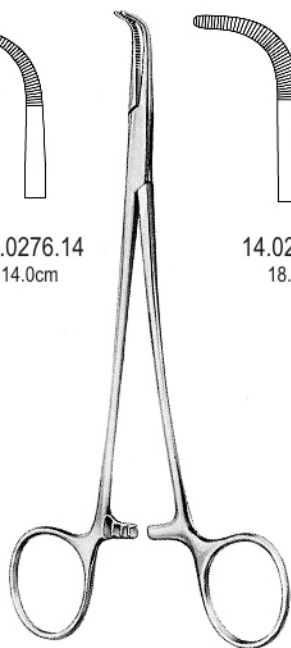

**BABY-ADSON**



14.0280.12 12.0cm

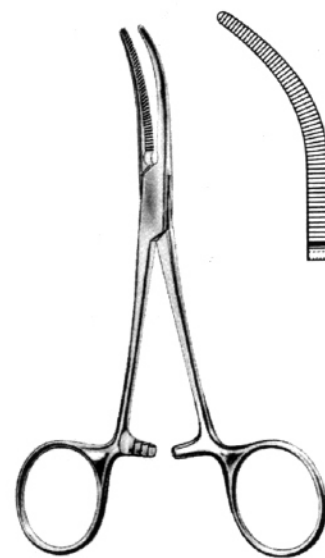

**BABY-OVERHOLT**  
14.0290.13 13.5cm

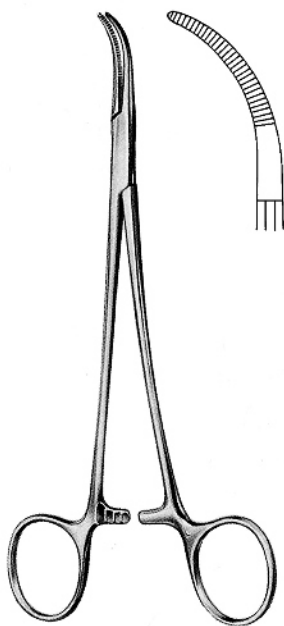

**MIXTER BABY**  
14.0292.14 14.0cm

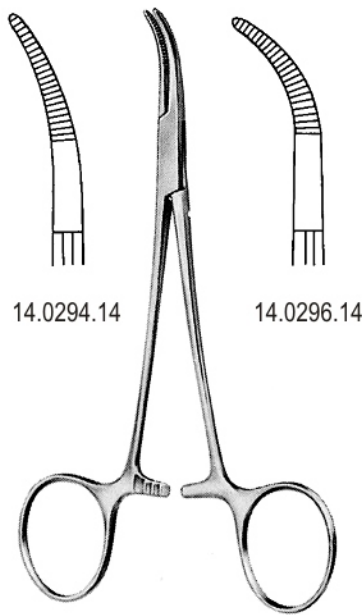

14.0294.14

14.0296.14

**BABY-MIXTER**  
14.0cm

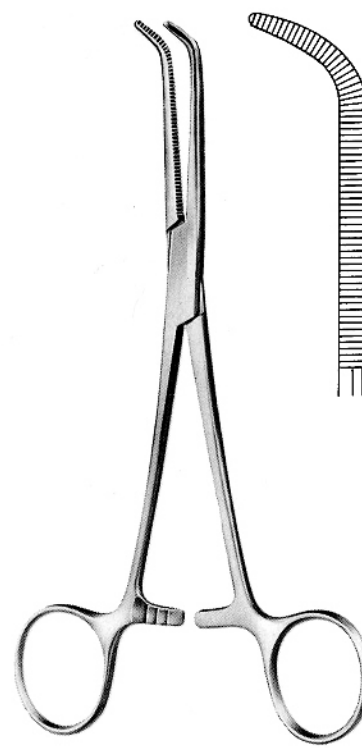

**BABY-MIXTER**  
14.0298.18 18.0cm

14.0298.18

**14-012**

www.hilbro.net

## ARTERY FORCEPS

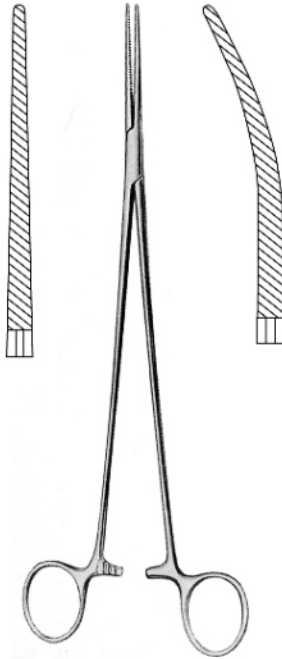

**BENGOLEA**

14.0300.20 20.0cm 14.0301.20  
14.0300.24 24.0cm 14.0301.24  
14.0300.26 26.0cm 14.0301.26

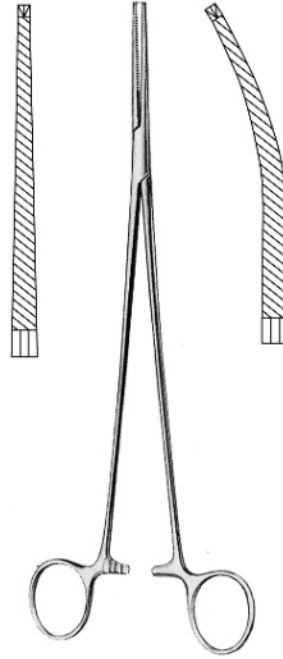

**BENGOLEA**

14.0302.20 20.0cm 14.0303.20  
14.0302.24 24.0cm 14.0303.24  
14.0302.26 26.0cm 14.0303.26

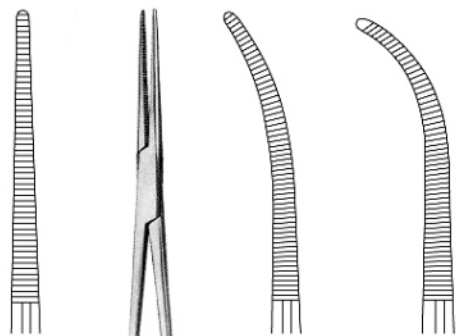

14.0310.20

14.0311.20

14.0313.20



**HEISS**  
20.0cm

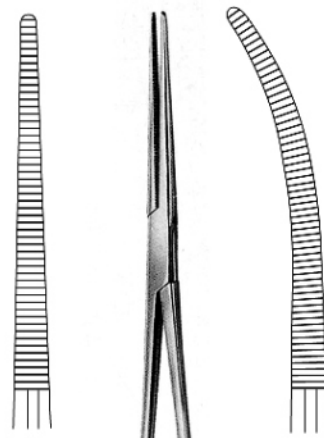

14.0316.22

14.0317.22



**ROBERTS**  
22.0cm

14.0317.22

**14-013**

[www.hilbro.net](http://www.hilbro.net)

EN Dissecting and ligature Forceps

DE Präparier-und Ligaturklemmen

ES Pinzas para preparaciones y ligaduras



## ARTERY FORCEPS

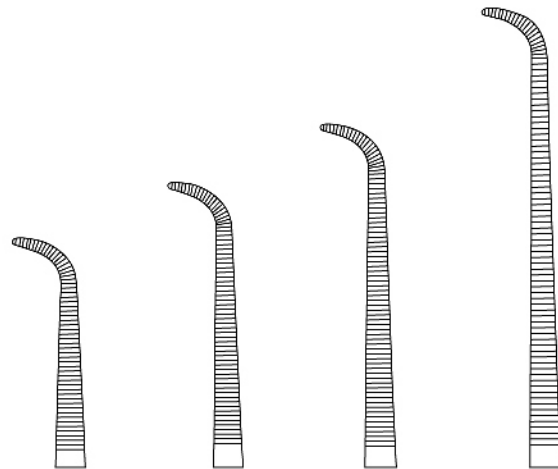
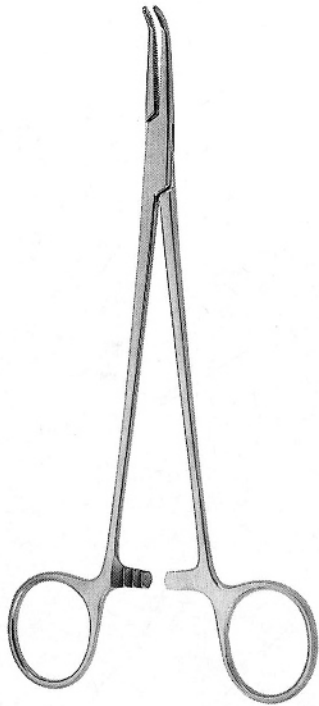

<b>MINI-GEMINI</b>	14.0320.18	14.0320.22	14.0320.25	14.0320.28
	18.0cm	22.0cm	25.0cm	28.0cm

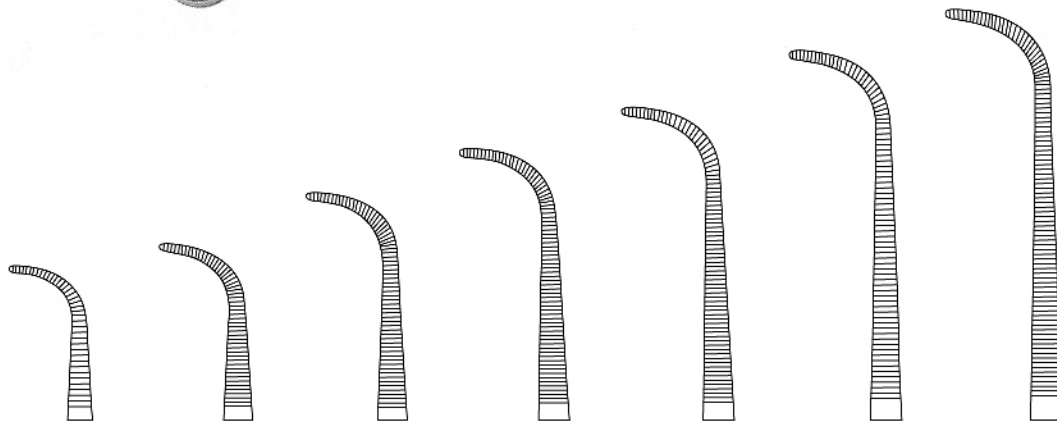

<b>GEMINI</b>	14.0322.13	14.0322.16	14.0322.18	14.0322.20	14.0322.23	14.0322.25	14.0322.28
	13.0cm	16.0cm	18.0cm	20.0cm	23.0cm	25.0cm	28.0cm

14.0322.28

**14-014**

[www.hilbro.net](http://www.hilbro.net)

Artery Forceps EN

Arterienklemmen DE

Pinzas hemostaticas ES

14

ARTERY FORCEPS

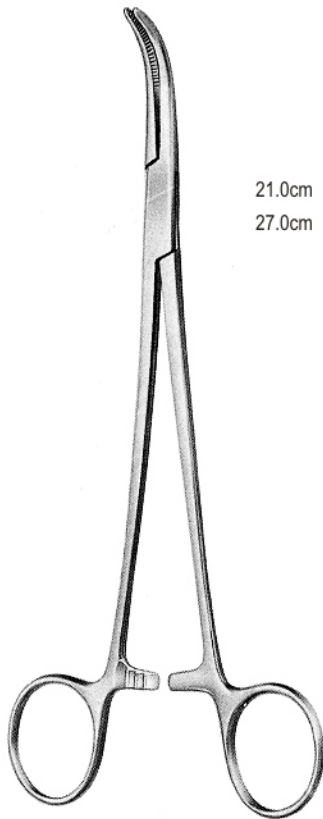

OVERHOLT-GEISSENDOERFER

21.0cm	14.0331.21	14.0332.21	14.0333.21	14.0334.21
27.0cm	14.0331.27	14.0332.27	14.0333.27	14.0334.27
21.0cm	14.0335.21	14.0336.21	14.0337.21	
27.0cm	14.0335.27	14.0336.27	14.0337.27	

14.0337.27

14-015

www.hilbro.net



## ARTERY FORCEPS



**OVERHOLT**

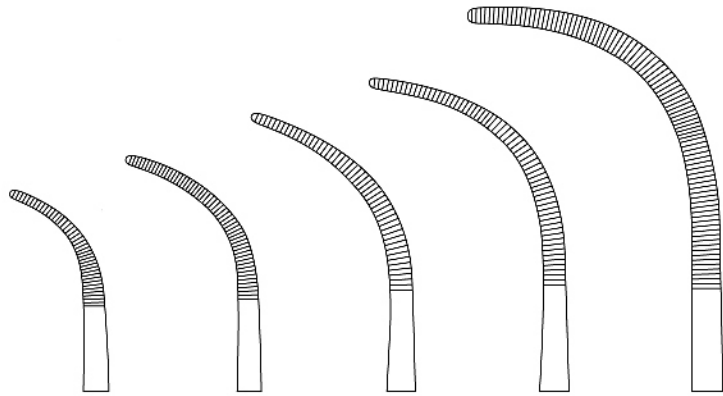

14.0340.01 18.5cm    14.0340.02 20.5cm    14.0340.03 21.0cm    14.0340.04 21.5cm    14.0340.05 24.0cm

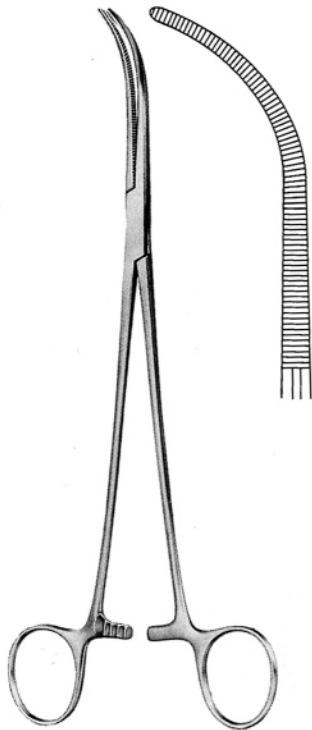

**OVERHOLT-MIXER**  
 14.0342.21 21.0cm

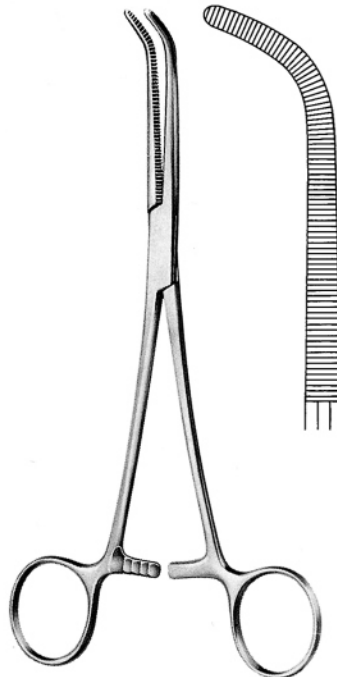

**MIXTER**  
 14.0344.22 22.0cm

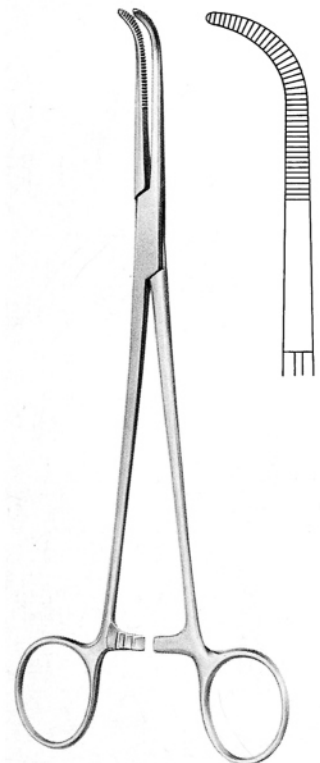

**MIXTER**  
 14.0346.23 23.0cm

14.0346.23

**14-016**

www.hilbro.net

ARTERY FORCEPS

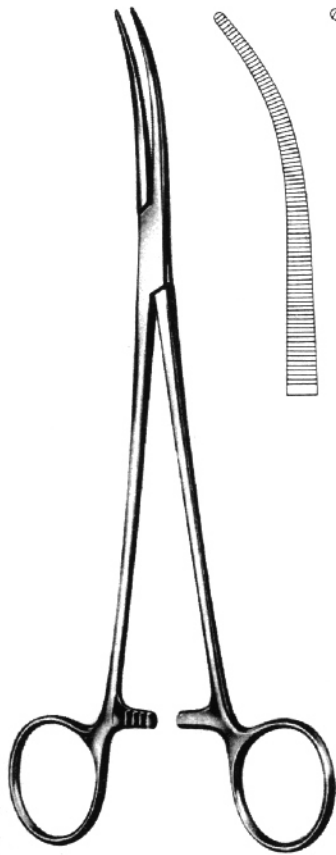

**KELLY**

19.0 cm 14.0350.19 14.0351.19 14.0353.19  
 22.0 cm 14.0350.22 14.0351.22 14.0353.22  
 24.0 cm 14.0350.24 14.0351.24 14.0353.24

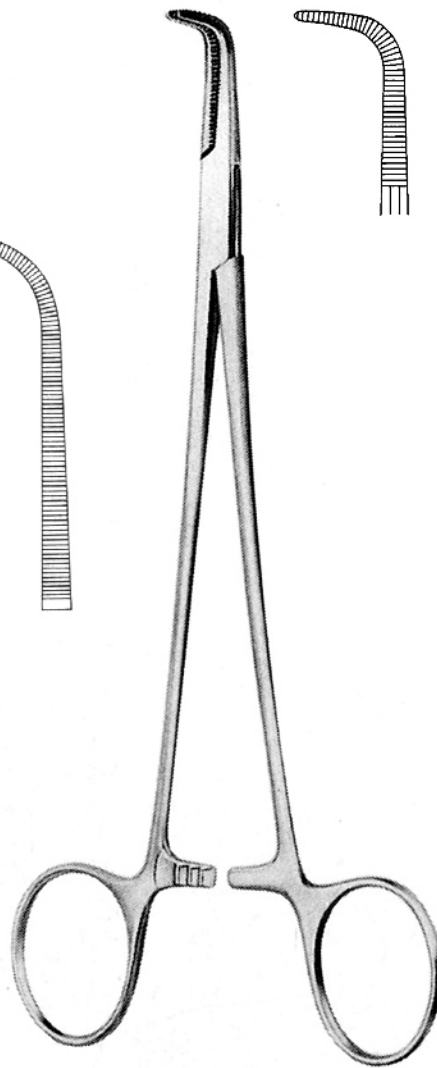

**MEEKER**

14.0356.27 27.5 cm

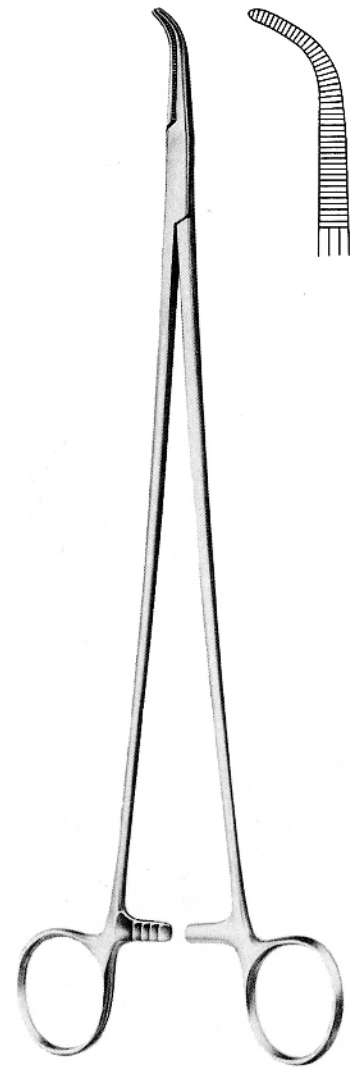

**LAWRENCE**

14.0358.27 27.5 cm

14.0358.27

**14-017**

www.hilbro.net

# 14

EN Artery Forceps, Dissecting Forceps

DE Arterienklemmen, Parparier

ES Pinzas hemostaticas, pinzas para preparaciones

**Hilbro**

## ARTERY FORCEPS

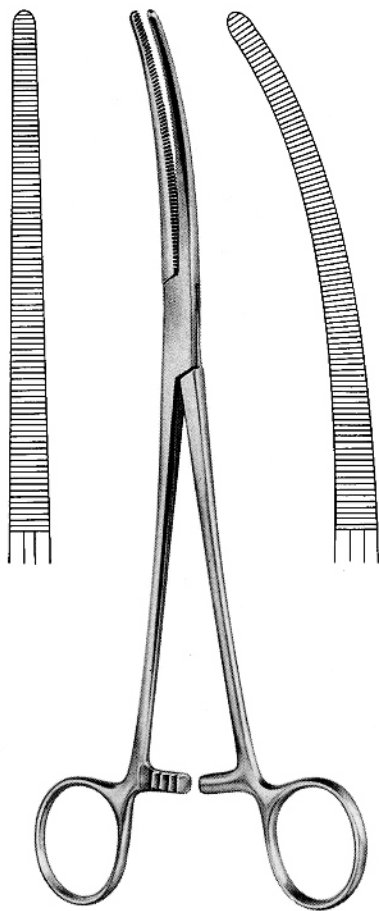

**SAROT**

14.0360.24 24.0cm 14.0361.24

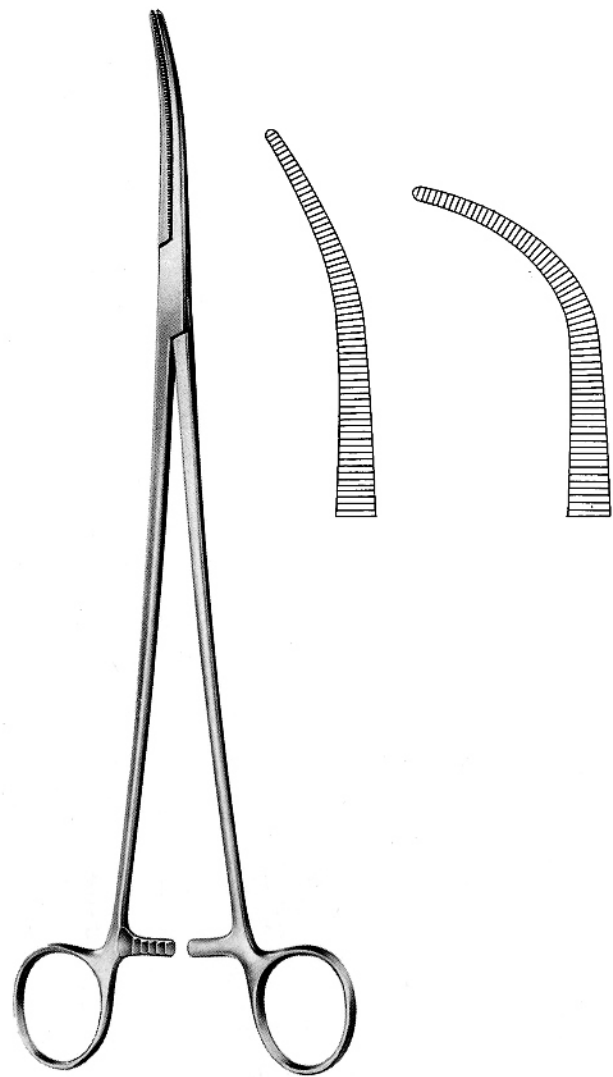

**ZENKER**

14.0366.01 29.5cm 14.0366.02

14.0366.02

**14-018**

[www.hilbro.net](http://www.hilbro.net)

ARTERY FORCEPS

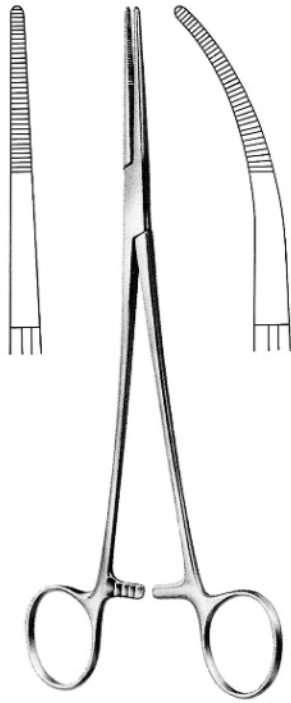

**TOENNIS**

14.0370.21 21.0cm 14.0371.21  
 14.0370.26 26.0cm 14.0371.26

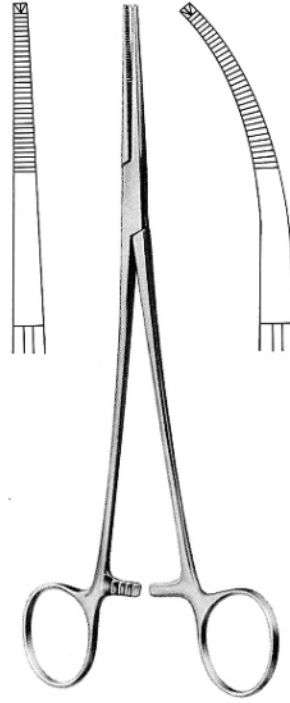

**TOENNIS**

14.0372.21 21.0cm 14.0373.21  
 14.0372.26 26.0cm 14.0373.26

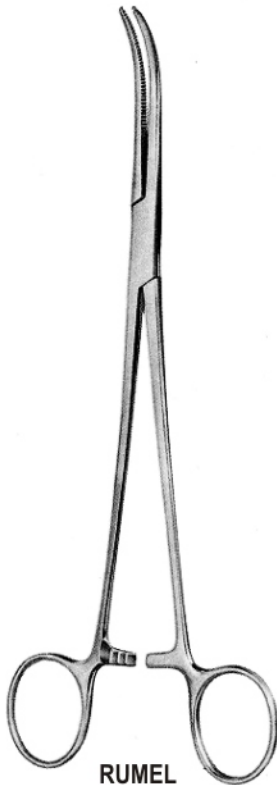

**RUMEL**  
 23.0cm

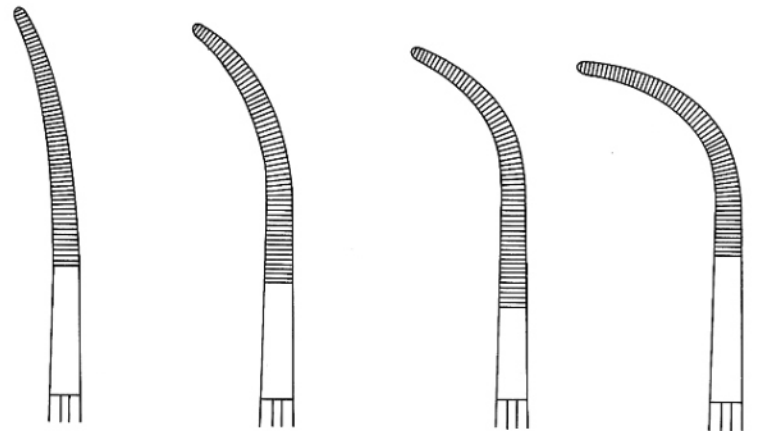

14.0380.01 14.0380.02 14.0380.03 14.0380.04 14.0380.05

14.0380.05

**14-019**

www.hilbro.net

EN Artery Forceps, Dissecting and Ligature Forceps

DE Arterienklemmen, Präparier- und Ligaturklemmen

ES Pinzas hemostáticas, pinzas para preparaciones y ligaduras



## ARTERY FORCEPS

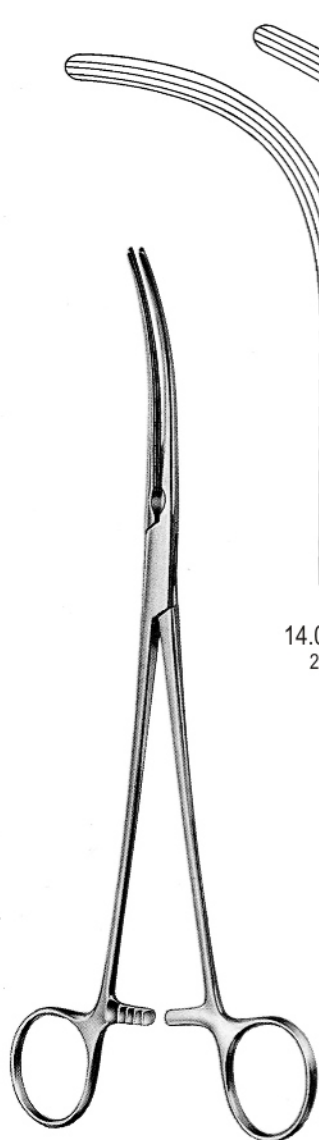

CRAFOORD-SELLORS

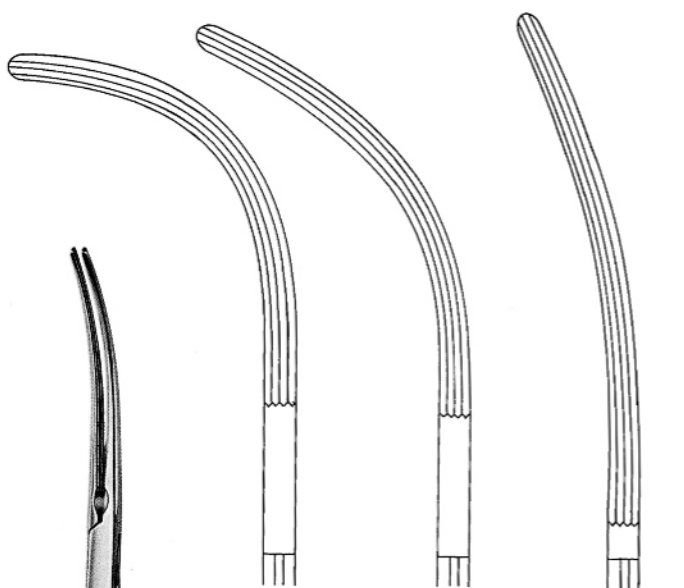

14.0386.01  
22.0cm

14.0386.02  
23.0cm

14.0386.03  
24.0cm

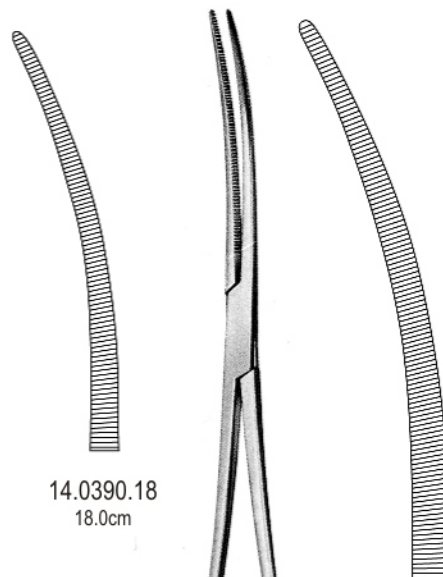

14.0390.18  
18.0cm

14.0390.24  
24.0cm

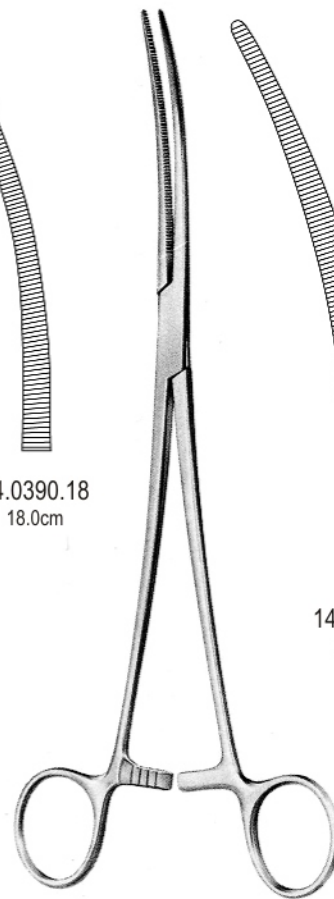

CRAFOORD

14.0390.24

**14-020**

www.hilbro.net

ARTERY FORCEPS

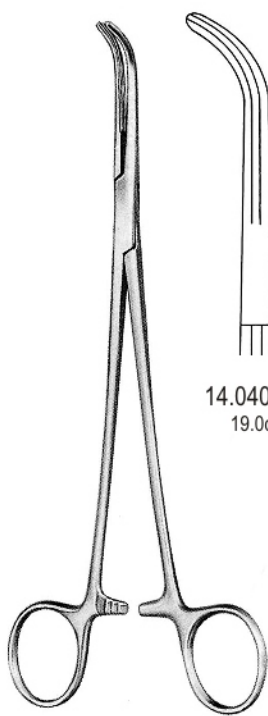

14.0400.19 19.0cm  
14.0400.23 23.0cm

LAHEY

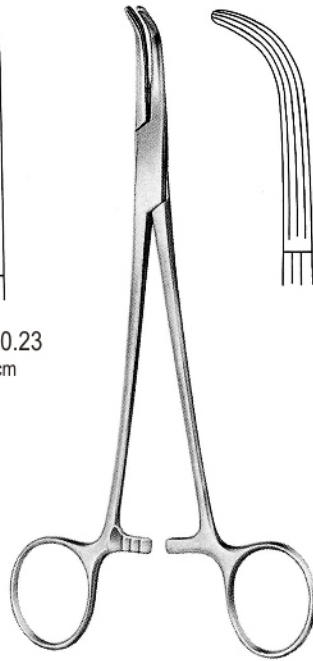

LOWER  
14.0406.18 18.0cm

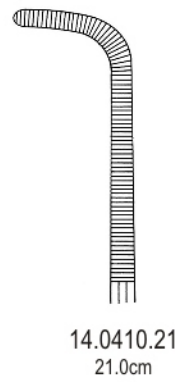

14.0410.21  
21.0cm

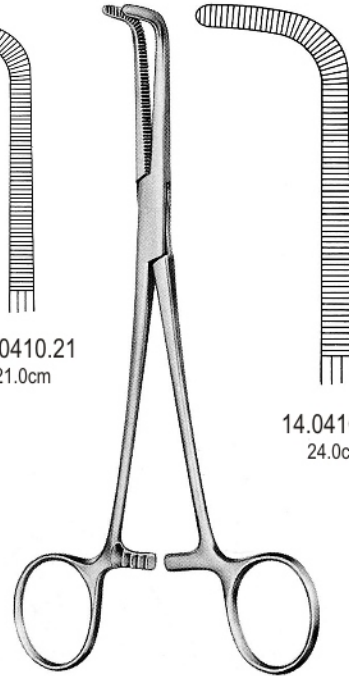

14.0410.24  
24.0cm

WICKSTRÖM

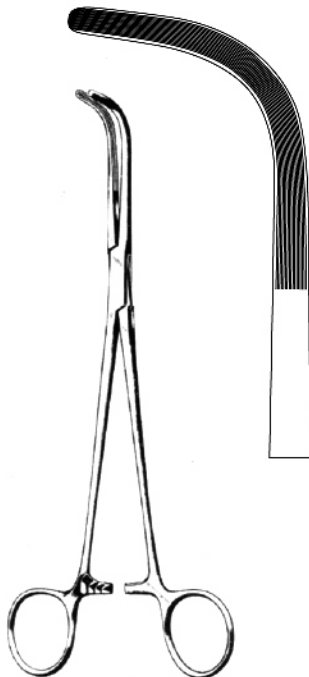

McQUIGG-MIXTER  
14.0416.22 22.0cm

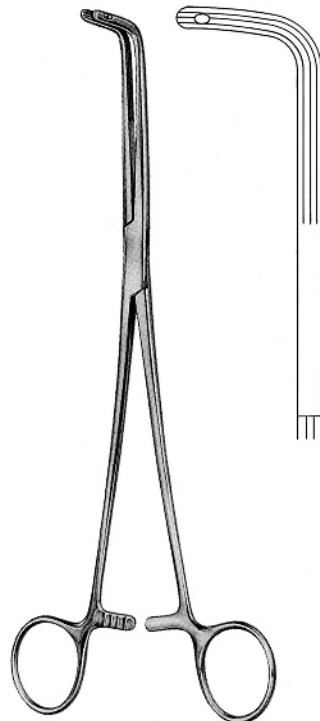

FINOCHIETTO  
14.0420.24 24.0cm

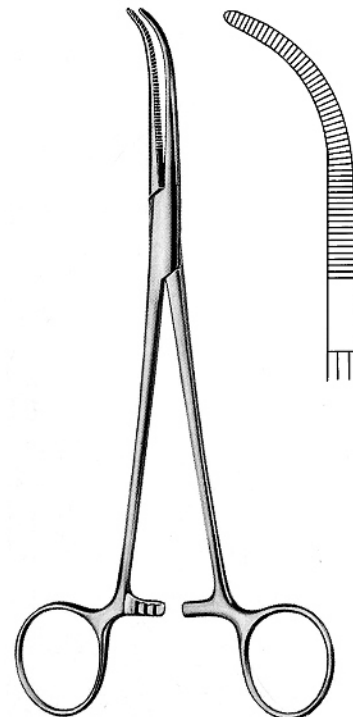

JOHNS HOPKINS  
14.0426.20 20.0cm

14.0426.20

14-021

www.hilbro.net



## ARTERY FORCEPS

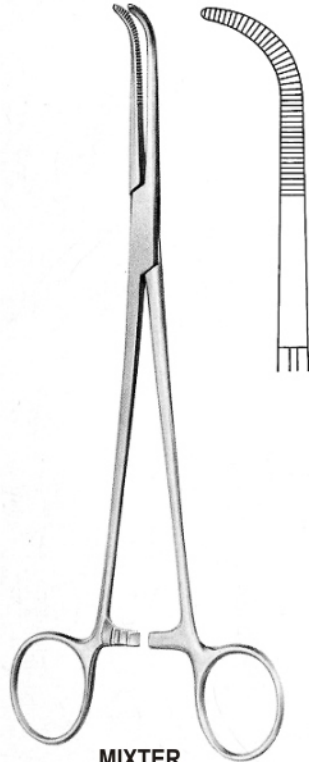

**MIXTER**  
14.0430.15 15.0cm  
14.0430.19 19.0cm

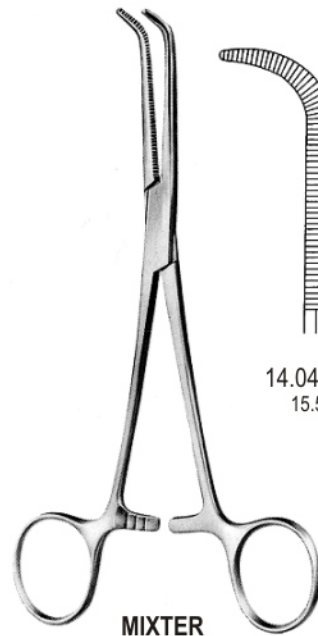

**MIXTER**

14.0432.15  
15.5cm

14.0432.18  
18.0cm

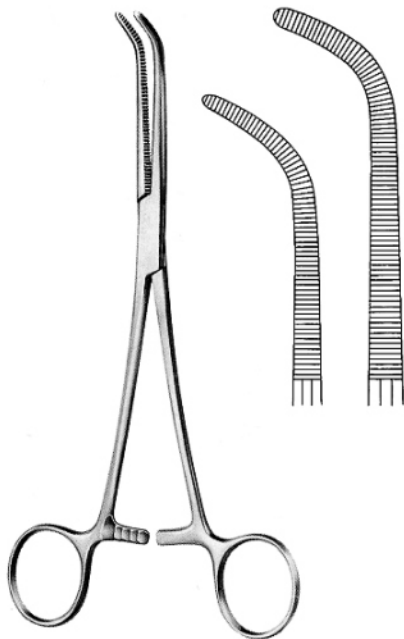

**MIXTER-O'SHAUGHNESSY**

14.0434.18 18.0cm  
14.0434.22 22.0cm



**MIXTER**

14.0441.22  
22.0cm

14.0441.25  
25.0cm

14.0441.28  
28.0cm

14.0441.28

**14-022**

www.hilbro.net

ARTERY FORCEPS

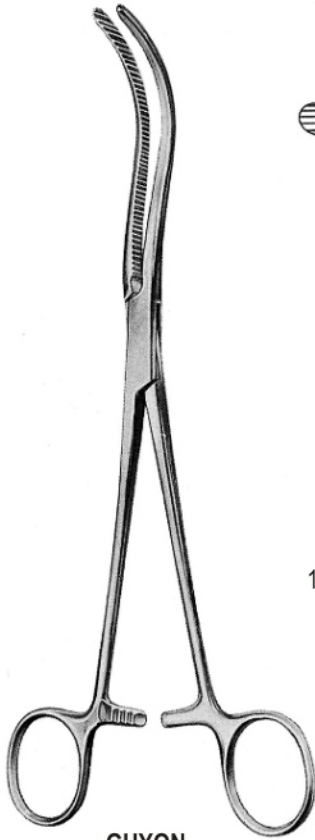

GUYON

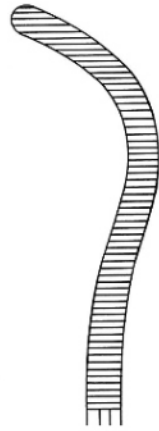

14.0450.20 20.0cm

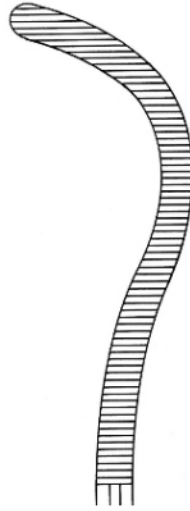

14.0450.22 22.0cm

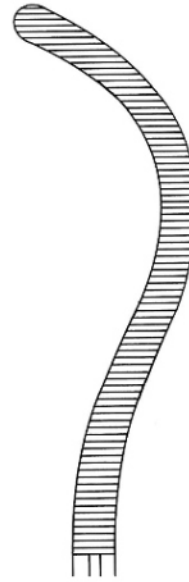

14.0450.24 24.0cm

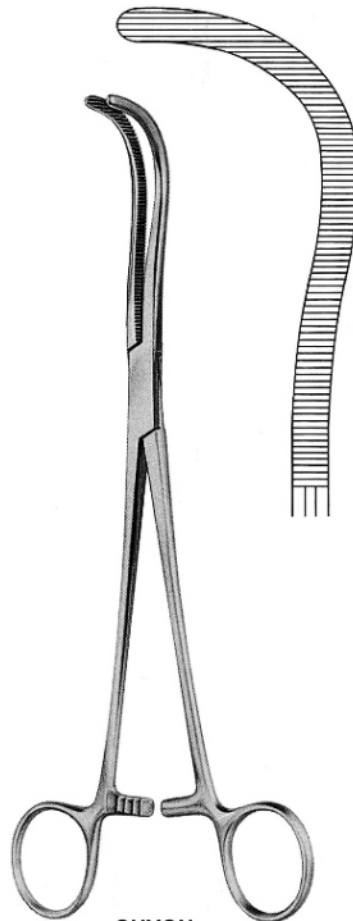

GUYON

14.0452.23 23.0cm

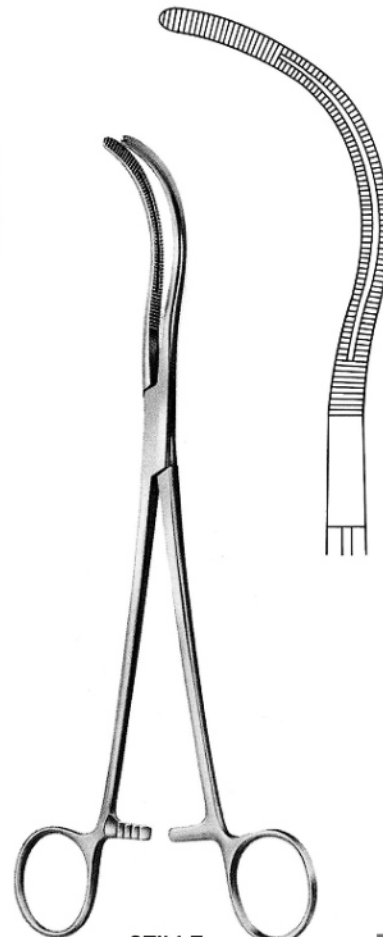

STILLE

14.0454.23 23.0cm

14.0454.23

14-023

www.hilbro.net



# 14

EN Kidney Pedicle Clamps

DE Nierenstielklemmen

ES Pinzas clamps para pedunculos renales

**Hilbro**

## ARTERY FORCEPS

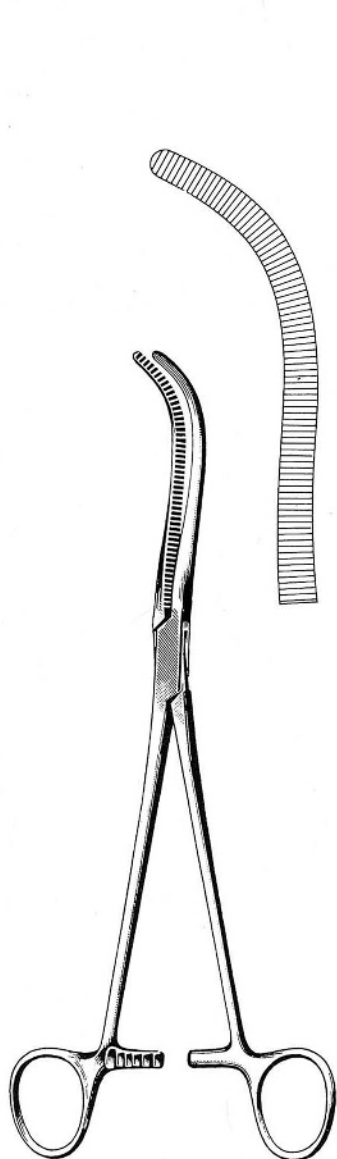

**MAYO**  
14.0456.23 23.0cm

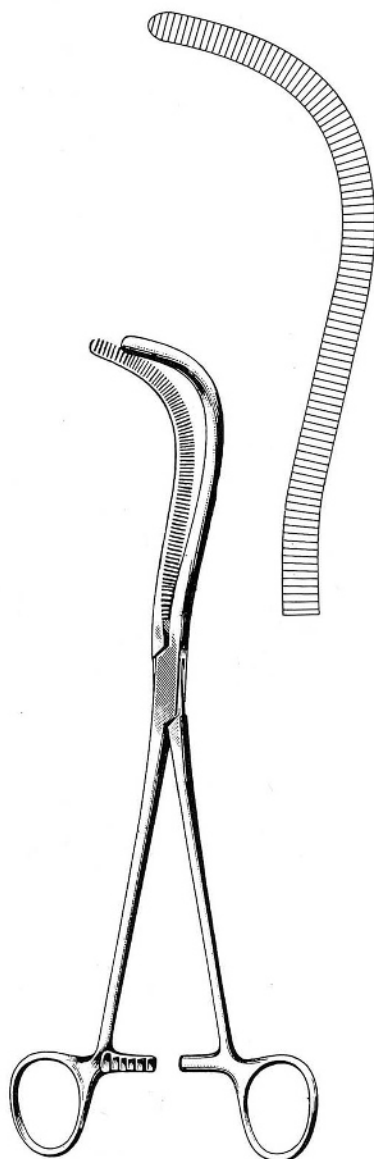

**MAYO-GUYON**  
14.0458.23 23.0cm

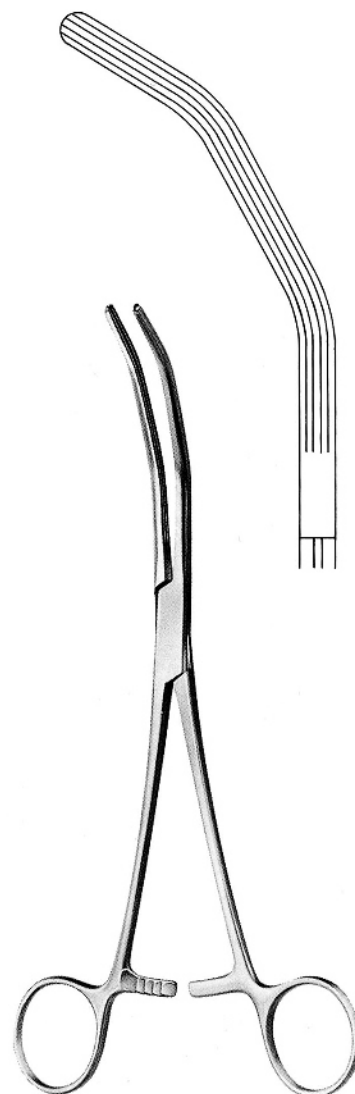

**MAYO-GUYON**  
14.0460.23 23.0cm

14.0460.23

**14-024**

[www.hilbro.net](http://www.hilbro.net)

ARTERY FORCEPS

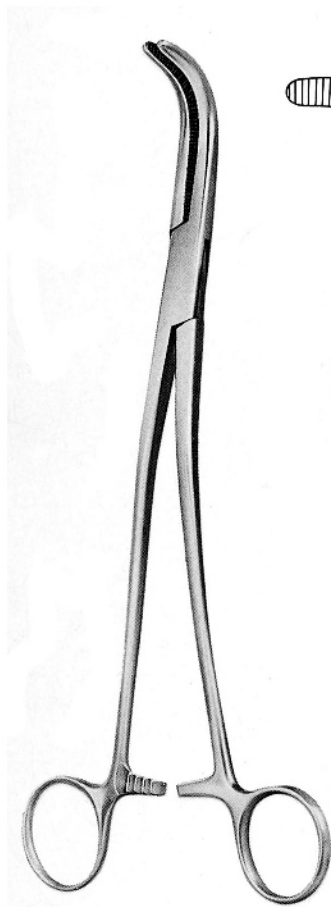

GRAY

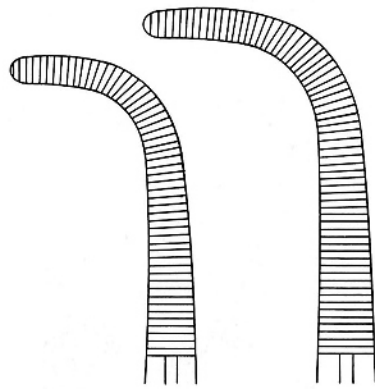

14.0464.22  
22.0cm

14.0464.23  
23.0cm

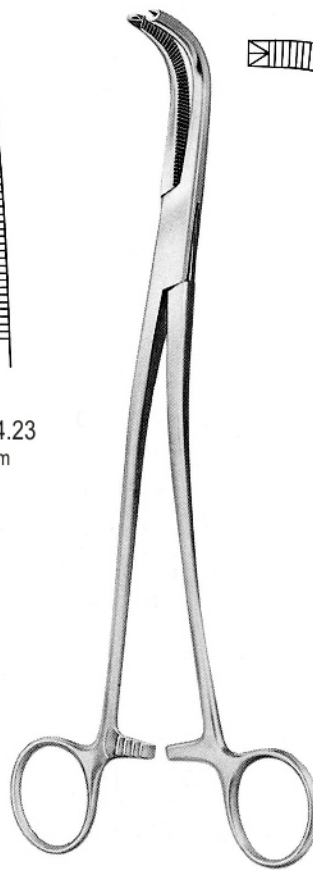

GRAY

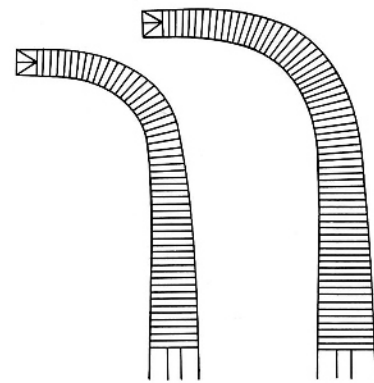

14.0468.22  
22.0cm

14.0468.23  
23.0cm

## ARTERY FORCEPS

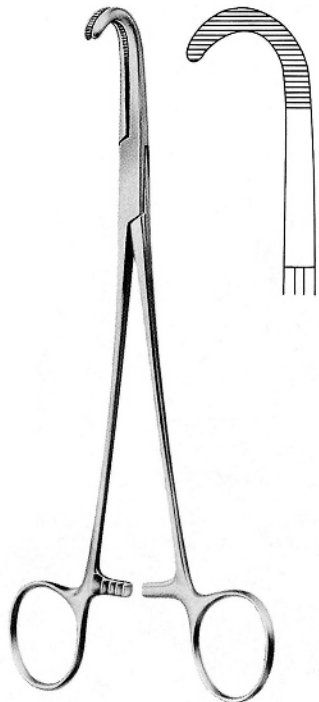

**DESJARDINS**  
 14.0470.21 21.0cm

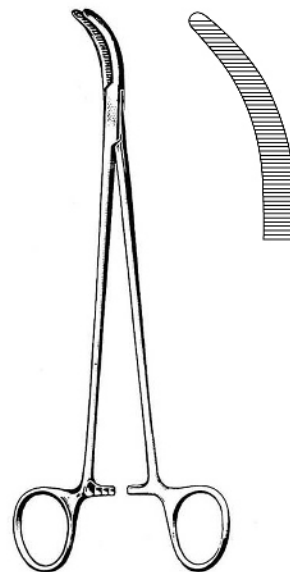

**DESJARDINS**  
 14.0472.21 21.0cm

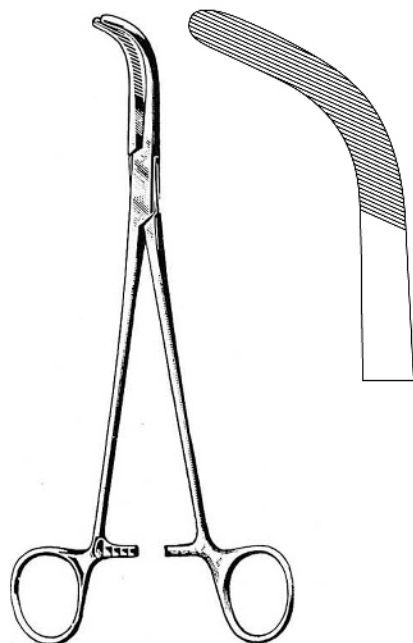

**CRILE**  
 14.0476.20 20.0cm

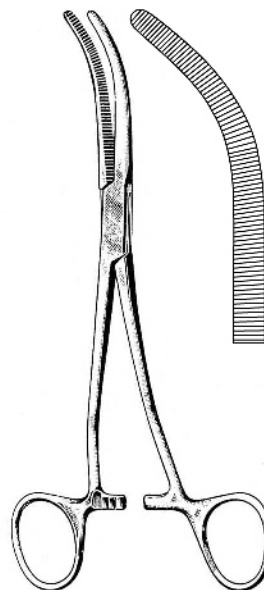

**DEAN-SHALLCROSS**  
 14.0480.18 18.0cm

14.0480.18

**14-026**

[www.hilbro.net](http://www.hilbro.net)

Tangential Forceps, Kidney Pedicle Clamps Forceps EN

Tangentialklemmen, Nierenstielklemmen DE

Pinzas tangenciales, pinzas-clamps para pedunculos Renales ES

14

ATRAUMA

ARTERY FORCEPS

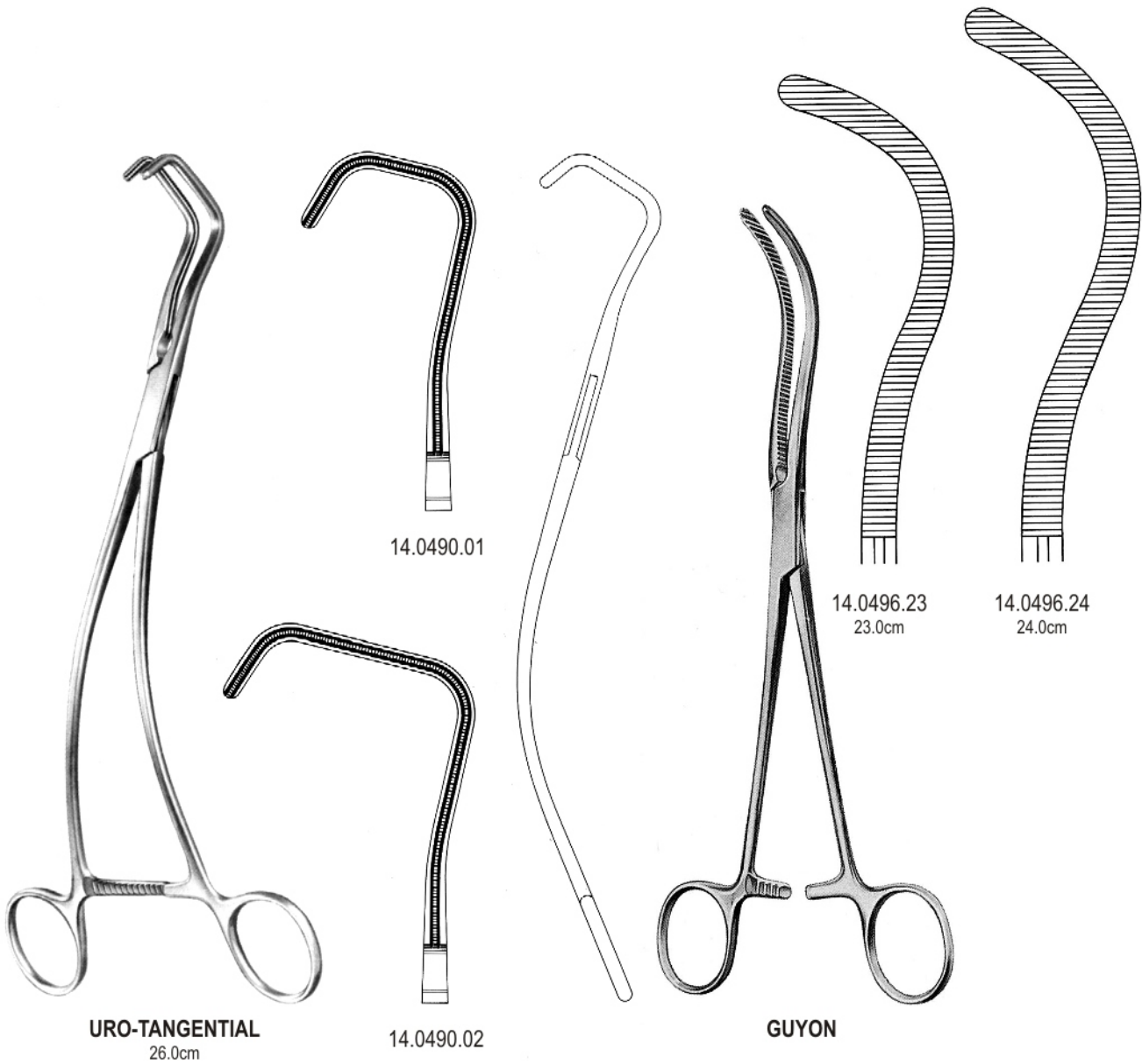

14.0496.24

14-027

www.hilbro.net

## ARTERY FORCEPS



**BABY-MIKULICZ**  
 14.0500.14 14.0cm

**MIKULICZ**  
 14.0500.18 18.0cm

**MIKULICZ**  
 14.0500.20 20.0cm

**MIKULICZ**  
 14.0502.20 20.0cm

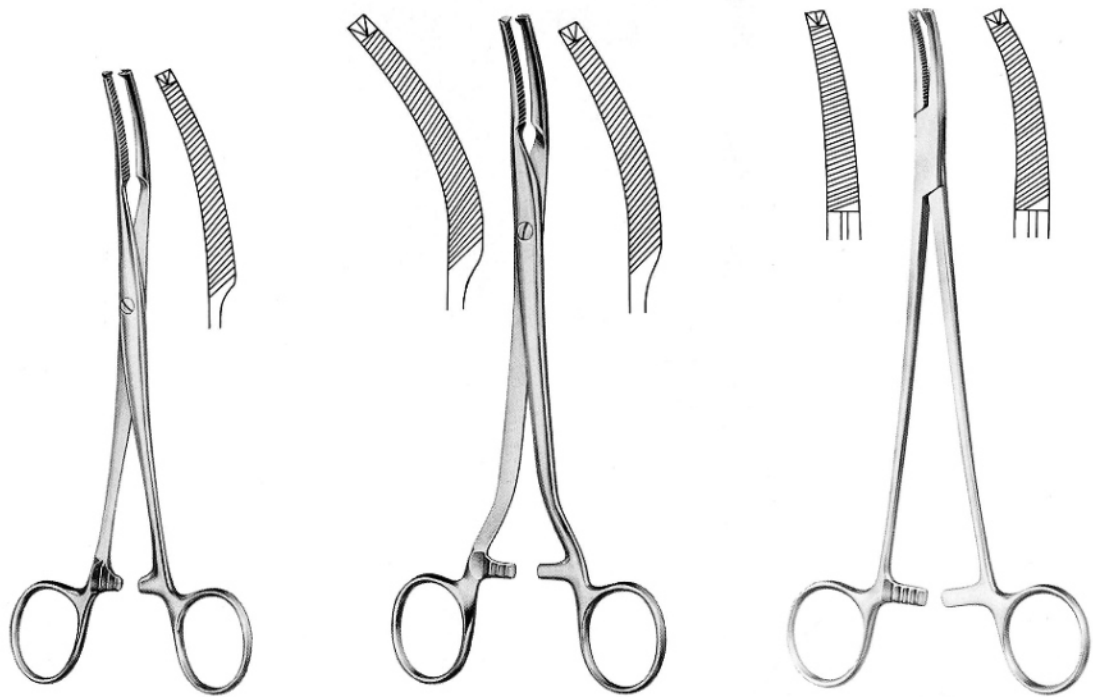

**MIKULICZ**  
 14.0504.18 18.0cm

**MIKULICZ**  
 14.0506.20 20.0cm 14.0508.20

**FAURE**  
 14.0512.20 20.0cm 14.0514.20

14.0514.20

**14-028**

www.hilbro.net

ARTERY FORCEPS

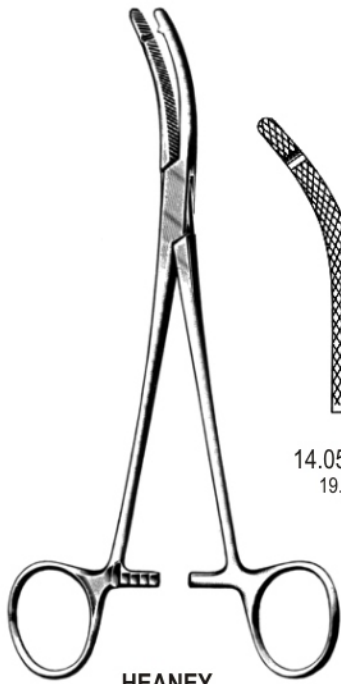

HEANEY



14.0520.19  
19.5cm



14.0520.21  
21.0cm



14.0520.23  
23.0cm



14.0522.19  
19.5cm



14.0522.21  
21.0cm



14.0522.23  
23.0cm

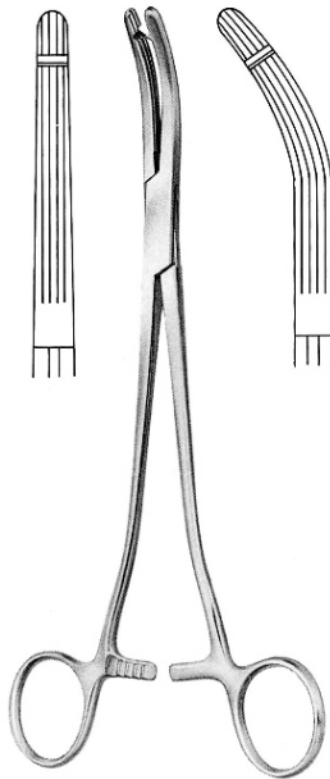

HEANEY-BALLENTINE  
14.0526.21 21.0cm 14.0527.21

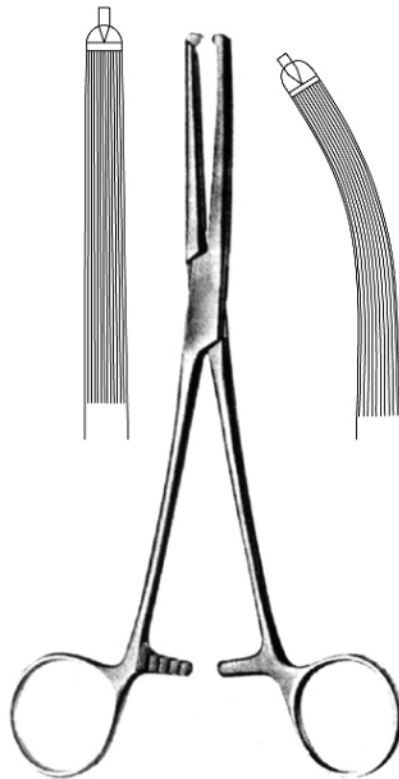

GWILLIAM  
14.0530.20 20.0cm 14.0531.20

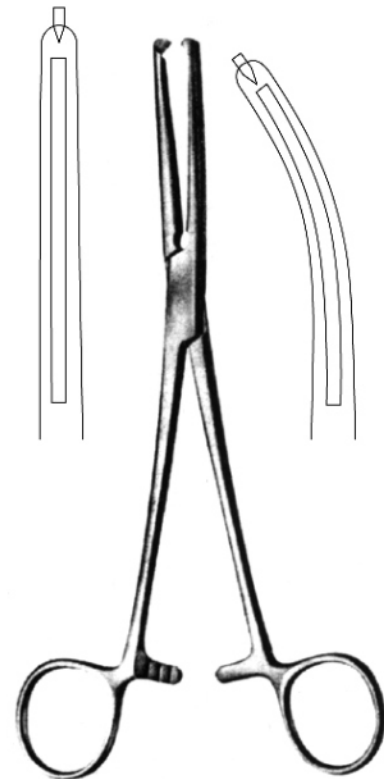

MAINGOT  
14.0536.20 20.0cm 14.0537.20

14.0537.20

14-029

www.hilbro.net

## ARTERY FORCEPS

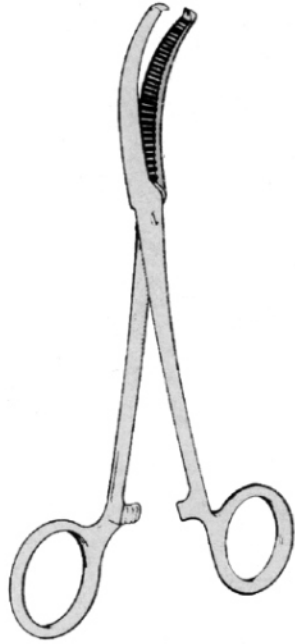

**BERKELEY**  
 14.0540.20 20.0 cm



**BERKELEY BONNEY**  
 14.0544.19 19.0 cm

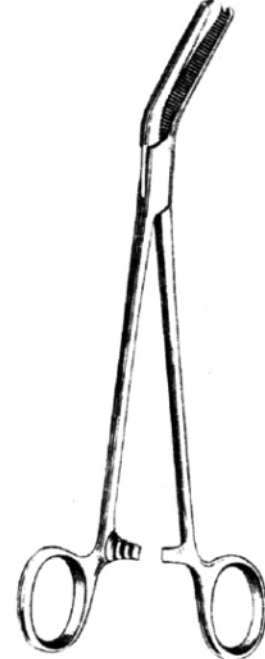

**BONNEY**  
 14.0548.20 20.5 cm

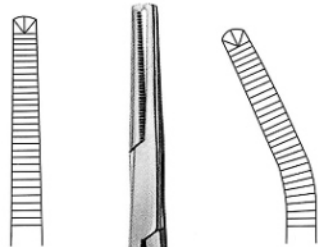

14.0550.21

14.0551.21

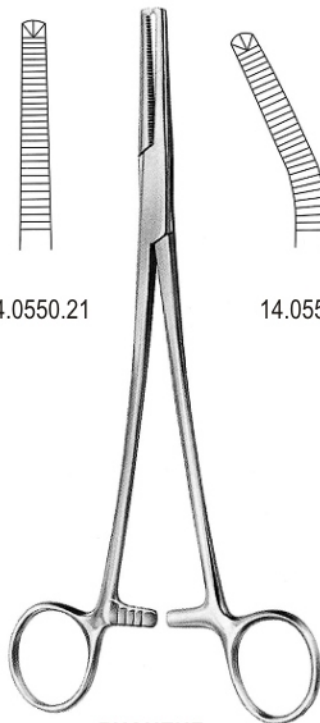

**PHANEUF**  
 21.0cm



14.0556.23  
 23.0 cm

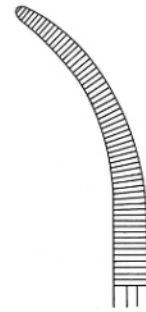

14.0556.24  
 24.0 cm

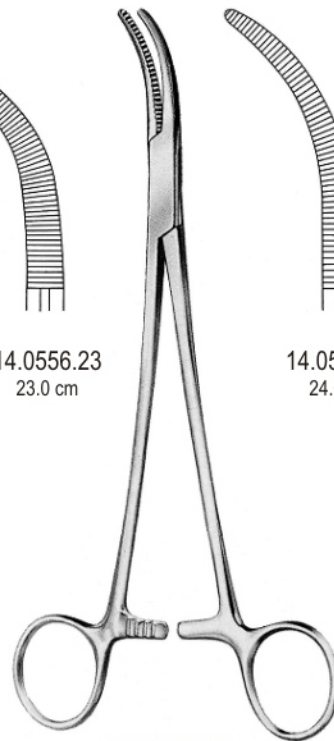

**MOYNIHAN**

ARTERY FORCEPS

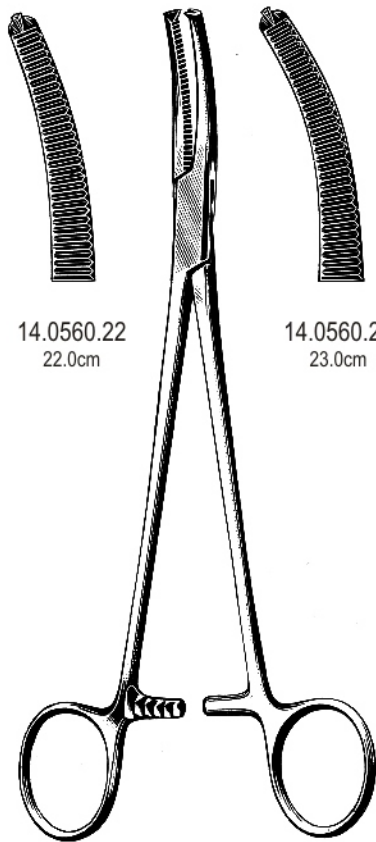

14.0560.22  
22.0cm

14.0560.23  
23.0cm

WERTHEIM

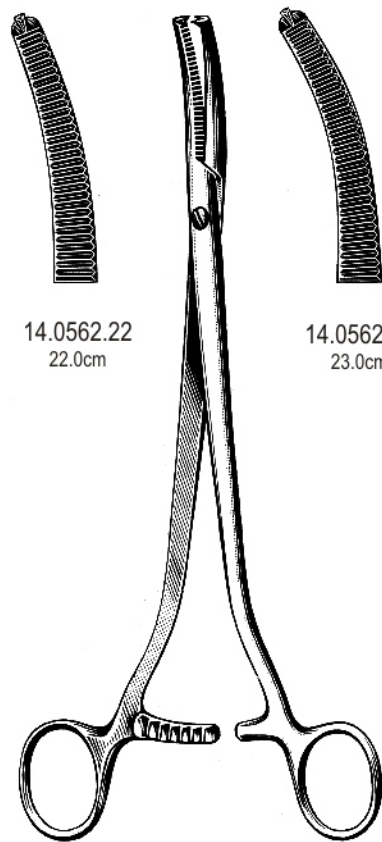

14.0562.22  
22.0cm

14.0562.23  
23.0cm

WERTHEIM

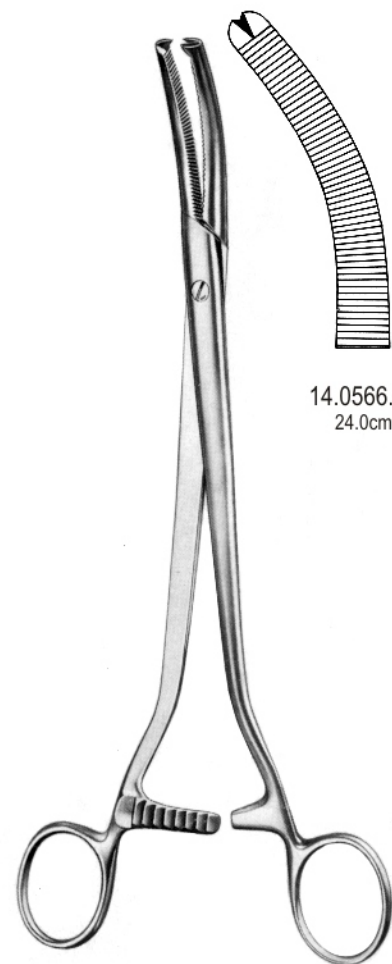

14.0566.24  
24.0cm

WERTHEIM

14.0566.24

14-031

www.hilbro.net



# 14

EN Hysterectomy Forceps

DE Hysterektomieklemmen

ES Pinzas para histerectomia

**Hilbro**

## ARTERY FORCEPS

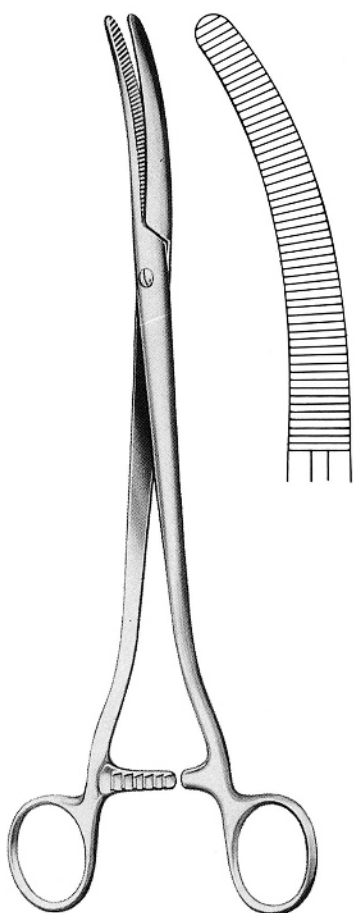

**FAURE**  
14.0570.25 25.0cm

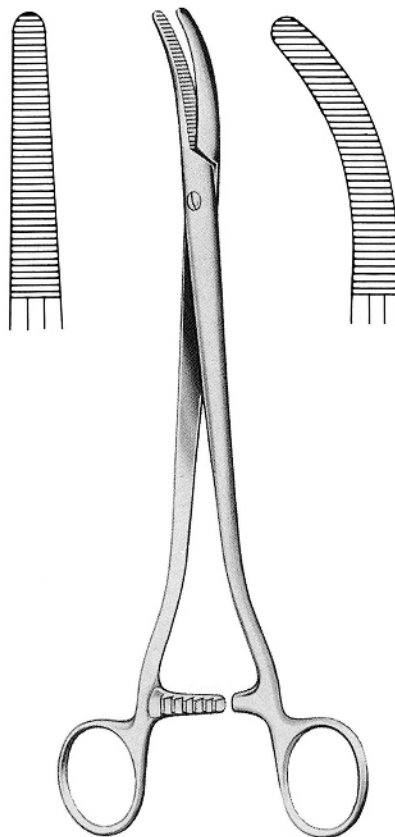

**SEKOND-LANDAU**  
14.0576.24 24.0cm 14.0577.24

14.0577.24

**14-032**

www.hilbro.net

ARTERY FORCEPS

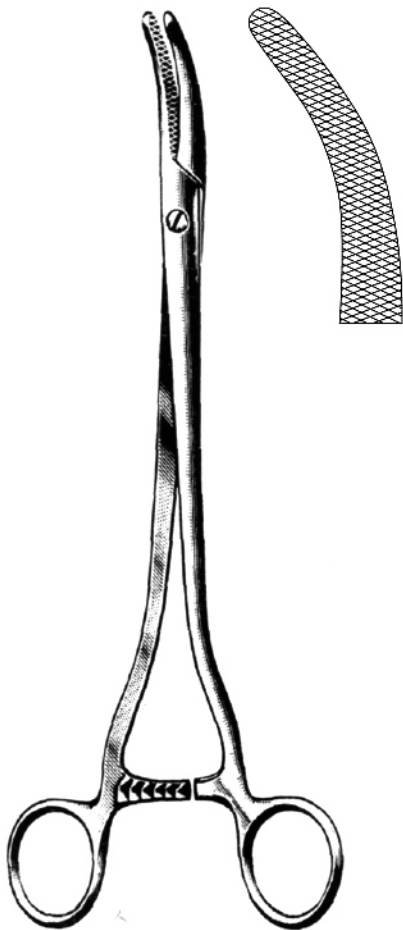

WERTHEIM  
14.0580.25 25.0cm

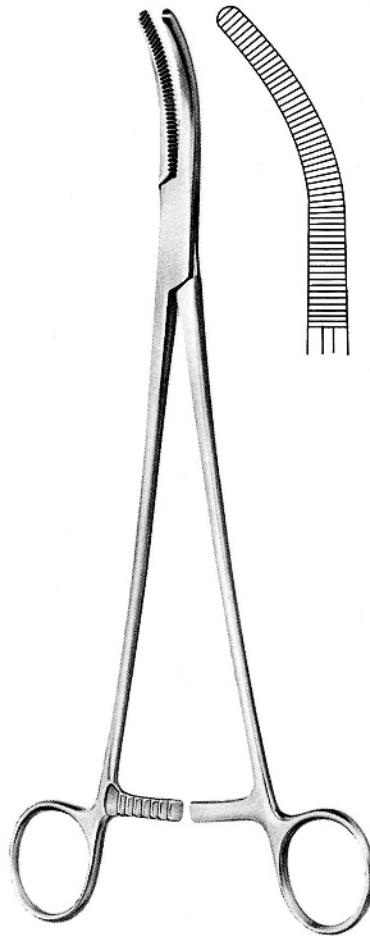

WERTHEIM  
14.0582.25 25.0cm

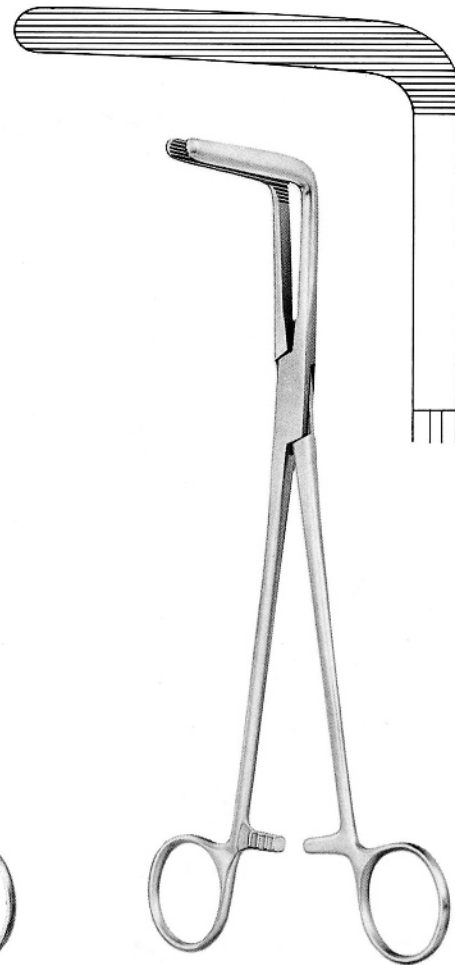

WERTHEIM-CULLEN  
14.0586.21 21.5cm

14.0586.21

14-033

www.hilbro.net

EN Clamps-Forceps, Hysterectomy and Vaginal Forceps

DE Klemmzangen, Hysterektomieklemmen, Vaginalklemmen

ES Pinzas-clamps, pinzas-clamps para histerectomia y vaginales



## ARTERY FORCEPS

ATRAUMA

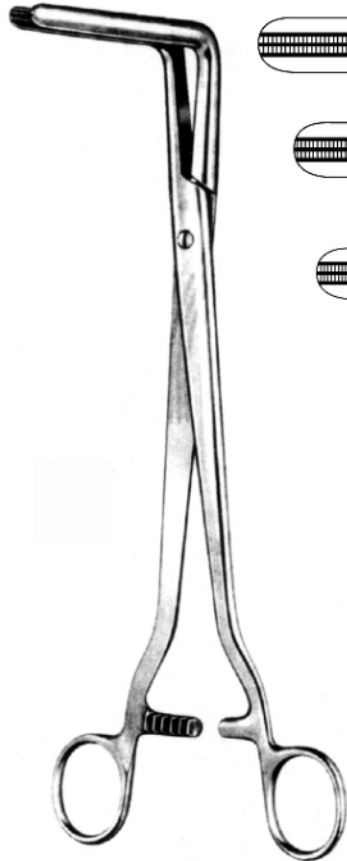

**WERTHEIM**  
24.0cm

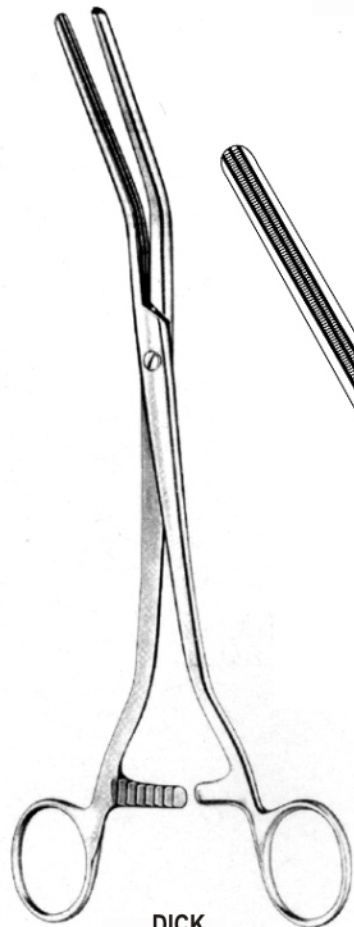
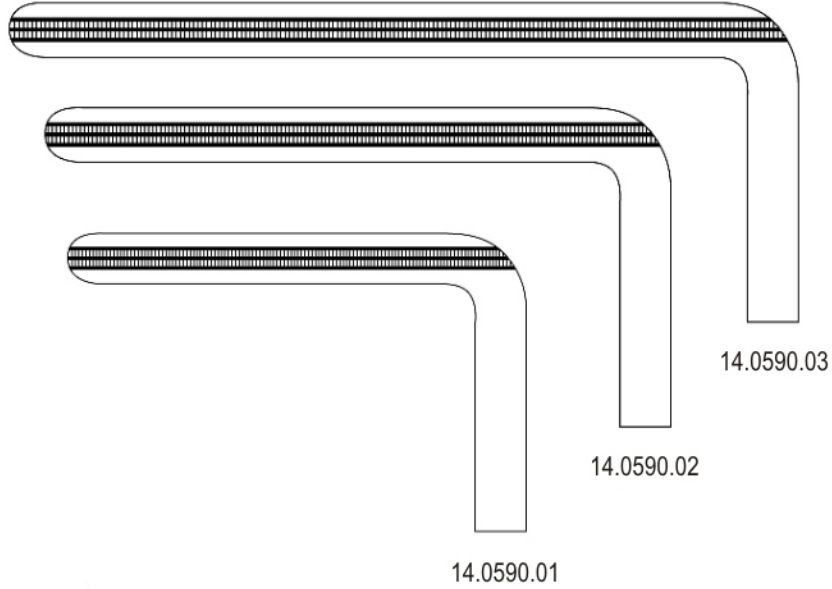

**DICK**

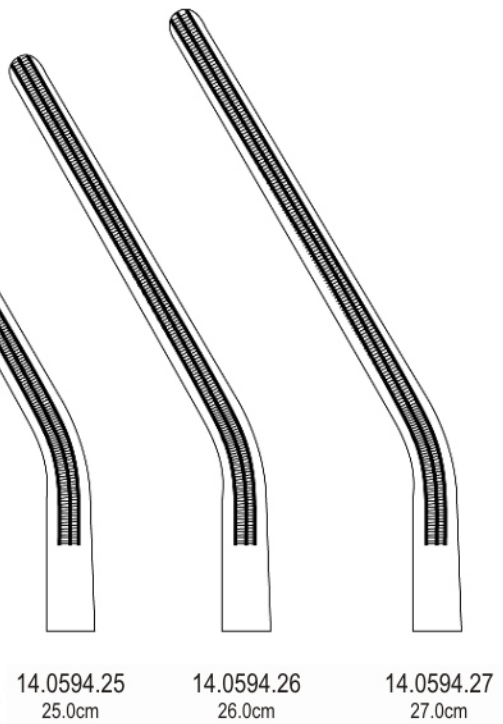

14.0594.27

**14-034**

www.hilbro.net

ATRAUMA

ARTERY FORCEPS



ROGERS

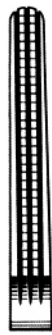

14.0600.01  
22.0cm



14.0600.02  
21.5cm



14.0600.03  
21.0cm

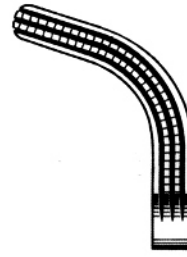

14.0600.04  
20.5cm



14.0602.01  
25.0cm



14.0602.02  
25.0cm

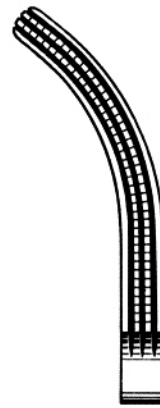

14.0602.03  
24.5cm

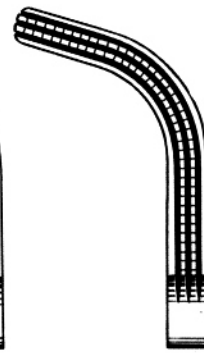

14.0602.04  
23.0cm

14.0602.04

14-035

www.hilbro.net



## ARTERY FORCEPS



**MARTEL**  
14.0620.14 14.0cm



**PRATT**  
14.0624.15 15.0cm

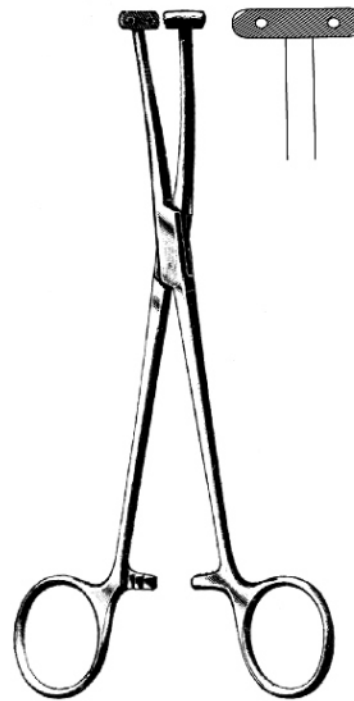

**WILLET-MARTEL**  
14.0628.19 19.0cm

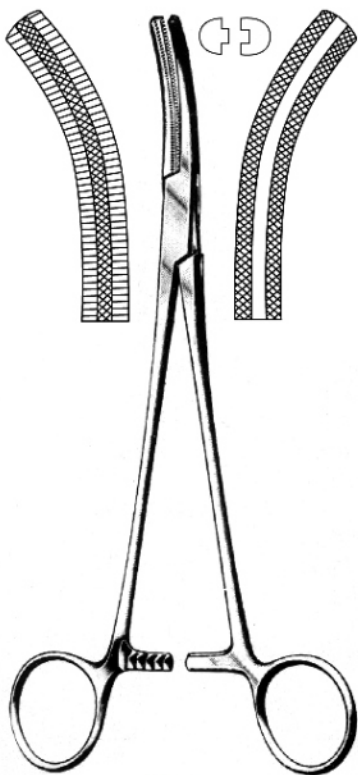

**BUIE**  
14.0630.21 21.0cm



**FERGUSSON**

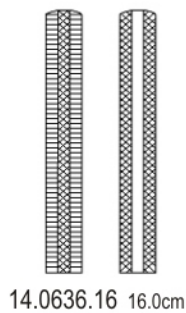

14.0636.16 16.0cm

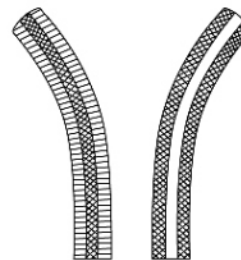

14.0637.16 16.0cm

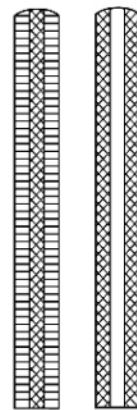

14.0636.20 20.0cm

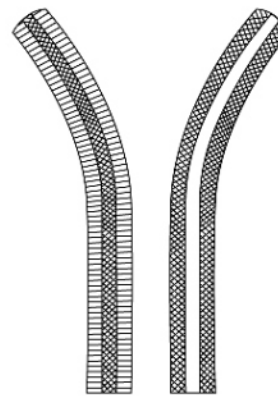

14.0637.20 20.0cm

14.0637.20

**14-036**

www.hilbro.net

ARTERY FORCEPS

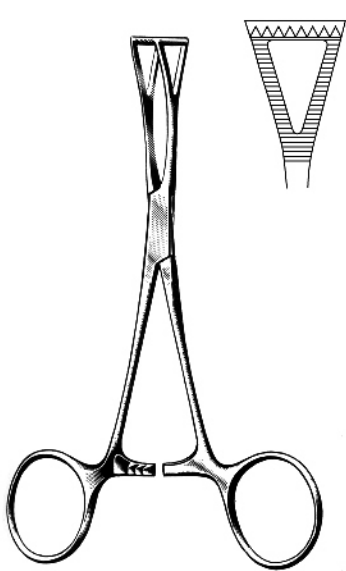

**COLLIN**  
 14.0640.14 14.0cm

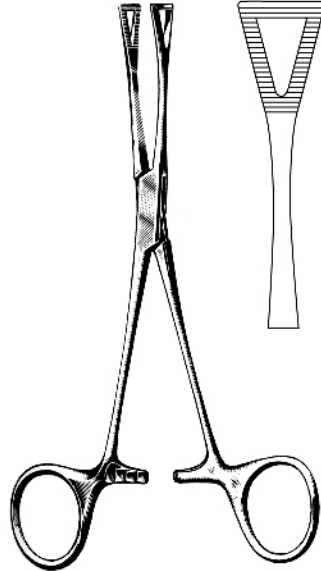

**PENNINGTON**  
 14.0646.15 15.5cm  
 14.0646.20 20.0cm

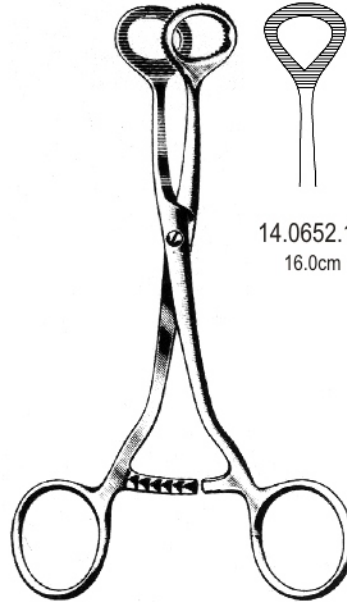

**COLLIN**  
 14.0650.16 16.0cm

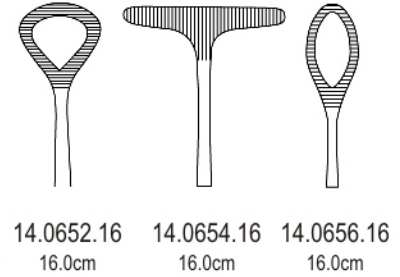

14.0652.16 16.0cm  
 14.0654.16 16.0cm  
 14.0656.16 16.0cm

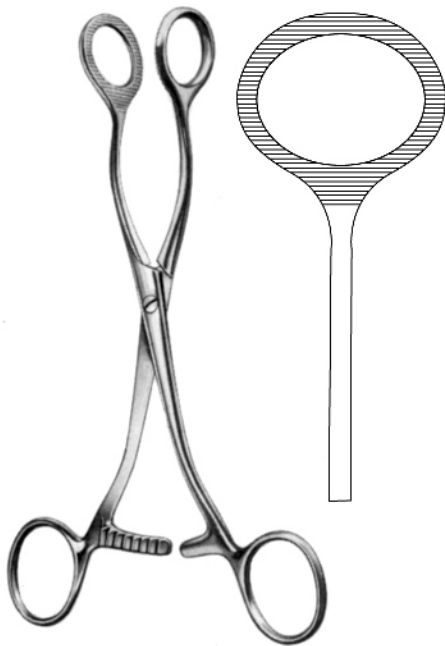

**COLLIN**  
 14.0658.16 16.5cm

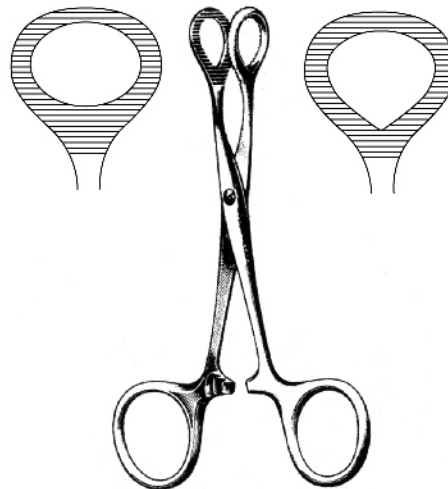

**PEAN**  
 14.0660.12 12.0cm 14.0662.12

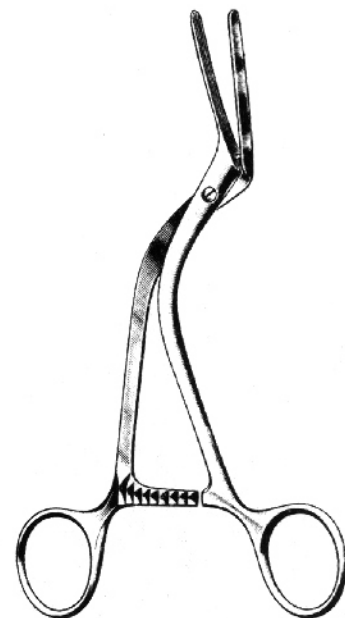

**HOPFNER**  
 14.0666.16 16.0cm

14.0666.16

**14-037**

www.hilbro.net

EN Tissue and Organ Holding Forceps

DE Gewebe-und Organ Faßzangen

ES Pinzas para tejidos y organos



## ARTERY FORCEPS

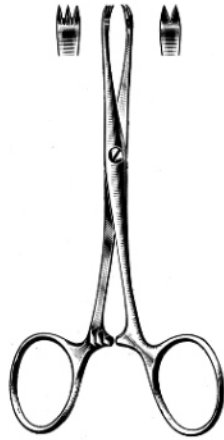

**CHAPUT**  
14.0670.13 13.0cm

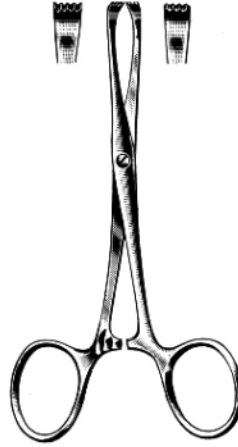

**TUFFIER**  
14.0674.13 13.0cm

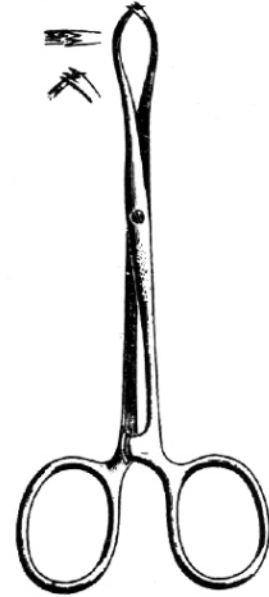

**PORRIER**  
14.0678.12 12.5cm  
14.0678.18 18.0cm



**LANE**  
14.0680.12 12.5cm  
14.0680.15 15.0cm  
14.0680.19 19.5cm

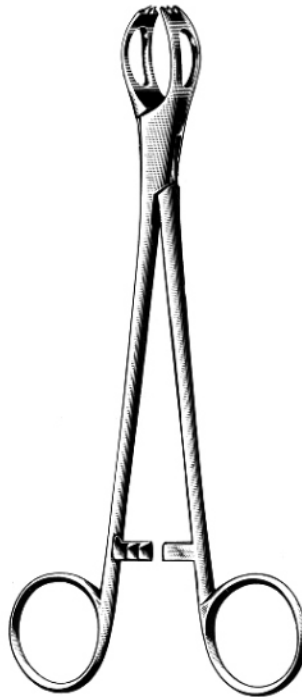

**LANE**  
14.0682.12 12.5cm  
14.0682.15 15.0cm  
14.0682.20 20.0cm



**ATRAUMA**



14.0686.25 25.0cm



14.0688.26 26.0cm

14.0688.26

**14-038**

www.hilbro.net

Tubing Clamp EN

Schlauchklemmen DE

Pinzas para tubos ES

# 14

## ARTERY FORCEPS



14.0690.14 14.5cm

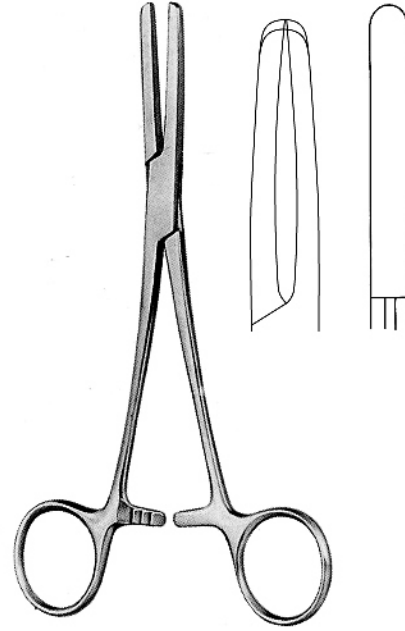

14.0692.16 16.5cm  
14.0692.18 18.0cm  
14.0692.20 20.0cm

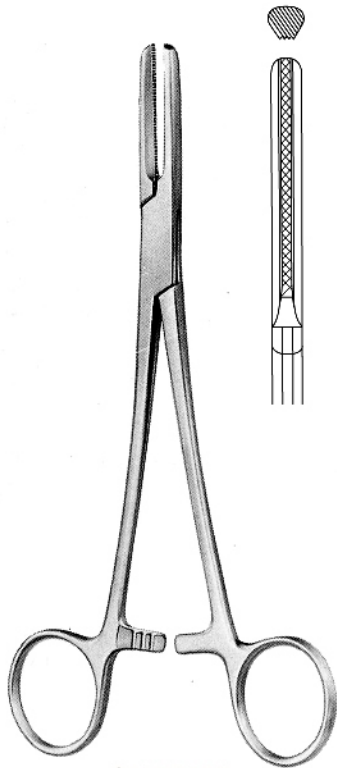

**STANDARD**  
14.0700.15 15.0cm  
14.0700.18 18.0cm  
14.0700.20 20.0cm

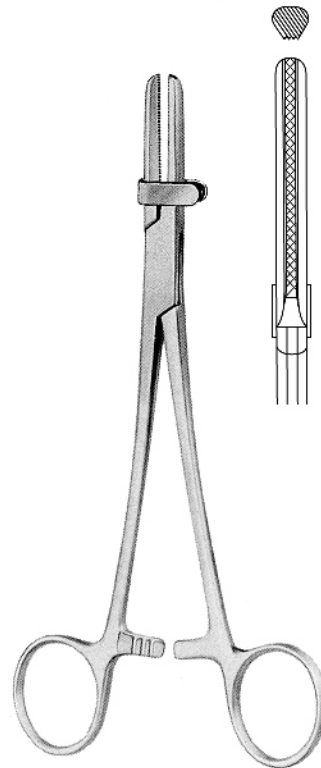

14.0702.15 15.0cm  
14.0702.16 16.5cm  
14.0702.18 18.0cm  
14.0702.20 20.0cm

14.0702.20

**14-039**

[www.hilbro.net](http://www.hilbro.net)



EN Towel Clamps

DE Tuchklemmen

ES Pinzas para compresas, pinzas de campo



## ARTERY FORCEPS



**LORNA**  
14.0710.10 10.0cm  
14.0710.13 13.0cm

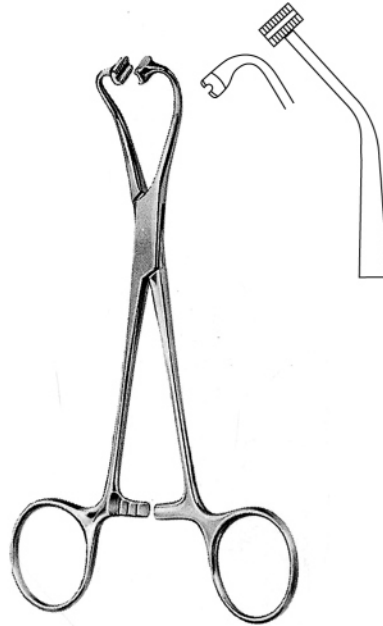

**PEERS-BERTRAM**  
14.0714.14 14.5cm

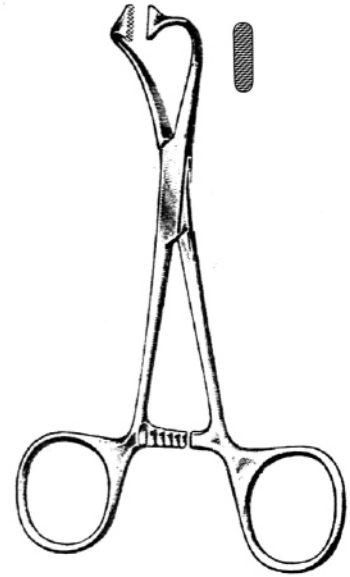

14.0718.10 10.0cm  
14.0718.13 13.0cm

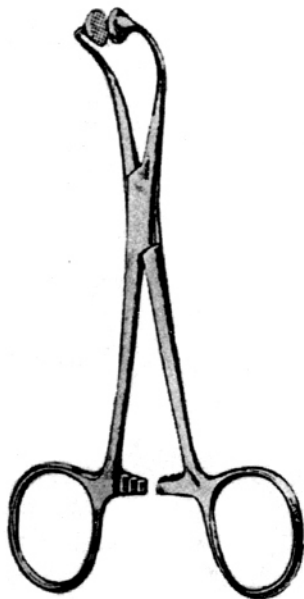

**HOFF (HOFER)**  
14.0720.10 10.0cm  
14.0720.14 14.5cm

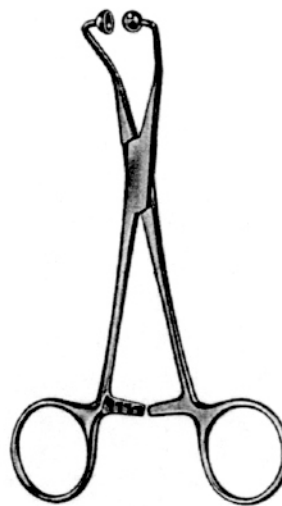

**BALL AND SOCKET**  
14.0722.13 13.0cm

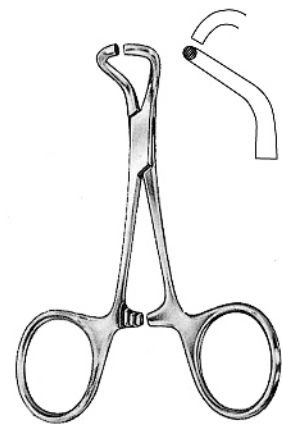

**TOHOKU**  
14.0726.10 10.0cm  
14.0726.13 13.0cm

14.0726.13

**14-040**

www.hilbro.net

Towel Clamps EN

Tuchklemmen DE

Pinzas para compresas, pinzas de campo ES

14

ARTERY FORCEPS



**SCHAEDEL**  
14.0730.09 9.0cm



**ENGLISH MODEL**  
14.0732.09 9.0cm



**JONES**  
14.0734.05 5.0cm  
14.0734.09 9.0cm



**JONES**  
14.0736.09 9.0cm



**BACKHAUS**  
14.0740.08 08.0cm  
14.0740.09 09.0cm  
14.0740.11 11.0cm  
14.0740.13 13.0cm  
14.0740.14 14.0cm  
14.0740.15 15.0cm



**DELICATE**  
14.0742.11 11.0cm  
14.0742.13 13.0cm

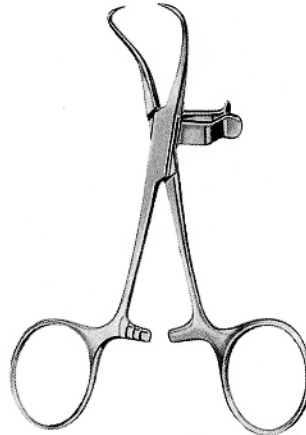

14.0746.11 11.0cm



**ROEDER**  
14.0750.13 13.0cm  
14.0750.15 15.0cm

14.0750.15

**14-041**

[www.hilbro.net](http://www.hilbro.net)

EN Towel Clamps

DE Tuchklemmen

ES Pinzas para compresas, pinzas de campo



## ARTERY FORCEPS



**ROBIN**  
14.0754.13 13.5cm



**ROBIN**  
14.0756.13 13.5cm



**BERNHARD**  
14.0758.16 16.5cm

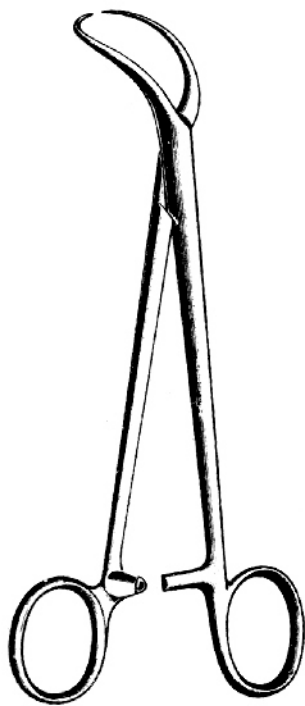

**MAYO**  
14.0760.14 14.0cm

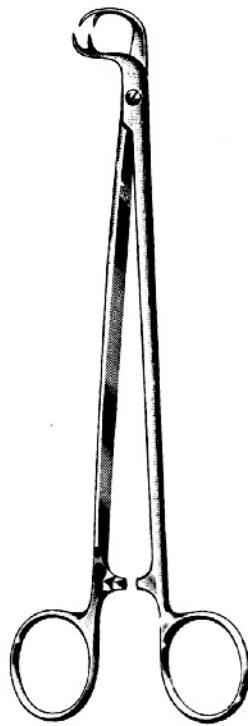

**MOYNIHAN**  
14.0762.19 19.0cm

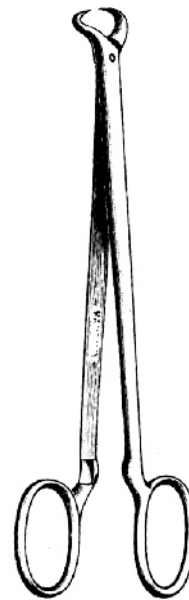

**MOYNIHAN**  
14.0764.18 18.0cm



**DOYEN**  
14.0766.18 18.0cm

14.0766.18

**14-042**

[www.hilbro.net](http://www.hilbro.net)