

BONE SURGERY

26



PAGE 001 to 020



- EN Bone Surgery
- DE Kochenchirurgie
- ES Cirugía ósea

SERVING HEALTHCARE WORLDWIDE

www.hilbro.net



BONE SURGERY



CHARRIERE
 26.0010.27 27.0cm
 26.0010.30 30.0cm
 26.0010.34 34.0cm

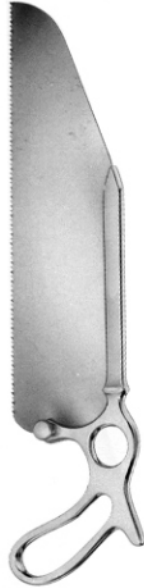

SATTERLEE
 26.0014.31 31.0cm



CHARRIERE
 26.0020.27 27.0cm
 26.0020.30 30.0cm



SATTERLEE
 26.0024.31
 31.0cm

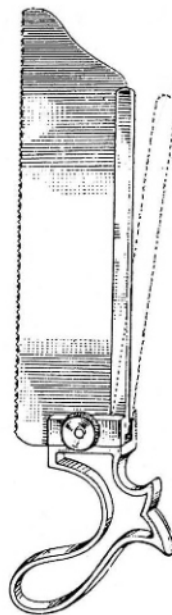

26.0030.23
 23.0cm



26.0034.19
 19.0cm

26.0034.19

26-001

www.hilbro.net



BONE SURGERY



SPARE SAW BLADE
 26.0040.12 12mm
 26.0040.15 15mm
 26.0040.18 18mm



CHAARRIERE
 26.0040.35 35.0cm



SPARE SAW BLADE
 26.0044.03 3mm
 26.0044.05 5mm
 26.0044.07 7mm



HELFERICH-BIER
 26.0044.39 39.0cm



LINDEMANN
 26.0050.20 20.0cm



LANGENBECK
 26.0054.23 23.0cm

26.0060.06 6mm
 26.0060.08 8mm
 26.0060.12 12mm
 26.0060.15 15mm
 26.0060.18 18mm

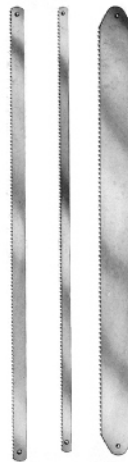

RUST
 26.0060.39 39.0cm



26.0060.39

26-002

www.hilbro.net

BONE SURGERY



STILLE-SHERMAN

24.0cm

26.0070.00 compl. set

26.0070.24 drill only



26.0072.25
2.5mm Ø



26.0072.30
3.0mm Ø



26.0072.35
3.5mm Ø



HUDSON

26.0074.00 compl. set / 6
(26.0074.27,01,
02,03,07,09)

26.0074.27 handle only



26.0076.01
9mm Ø



26.0076.02
14mm Ø



26.0076.03
16mm Ø



26.0076.04
22mm Ø



CUSHING
26.0076.05
14mm Ø



26.0076.06
2mm Ø



MCKENZIE
26.0076.07
13mm Ø



ERRICO
26.0076.08
16mm Ø



26.0076.09

26.0076.09

26-003

www.hilbro.net

EN Hand Drills

DE Handbohrapparate

ES Perforadores de mano



BONE SURGERY



STILLE

20.0cm

26.0080.00 compl. set

26.0080.20 drill only



26.0082.01
2.5mm Ø



26.0082.02
3.0mm Ø



26.0082.03
3.5mm Ø



26.0082.04
4.0mm Ø



26.0082.05
10.0mm Ø



26.0082.06
5.0mm Ø



26.0082.07
8.0mm Ø



26.0082.08
12.0mm Ø



26.0082.09
16.0mm Ø



26.0082.10
1.0mm Ø



26.0082.11
1.5mm Ø



26.0082.12
2.0mm Ø



26.0084.00 compl. set

26.0084.01 drill only



26.0084.09
9.0cm
3.2mm Ø



26.0084.07
7.0cm
3.2mm Ø

26.0084.08
Set of drills



JACOBS

26.0090.00 6.35mm



26.0092.00 set

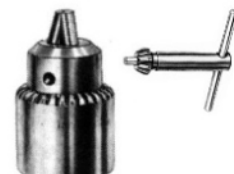

26.0094.00 set

26.0094.00

26-004

www.hilbro.net

BONE SURGERY



BUNNELL
26.0100.00



RALK
26.0104.00

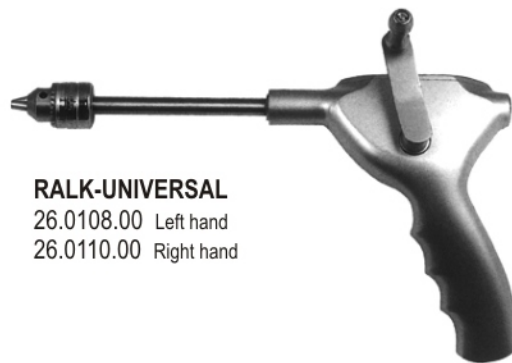

RALK-UNIVERSAL
26.0108.00 Left hand
26.0110.00 Right hand



26.0112.00

26.0112.00

26-005

www.hilbro.net



BONE SURGERY



26.0116.00



26.0120.00



26.0122.00



26.0124.01



26.0128.01



26.0128.02



26.0128.03

26.0128.03

26-006

www.hilbro.net

26.0124.00 complete set

KIRSCHNER
 26.0128.00 complete set

BONE SURGERY

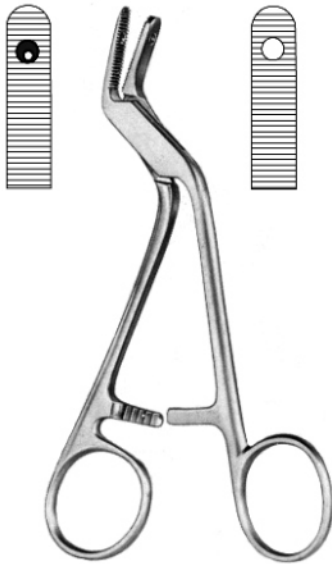

ADSON
 26.0130.15
 15.0cm



ADSON
 26.0134.18
 18.0cm

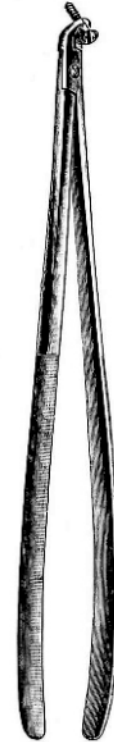

LANE
 26.0140.22
 22.0cm

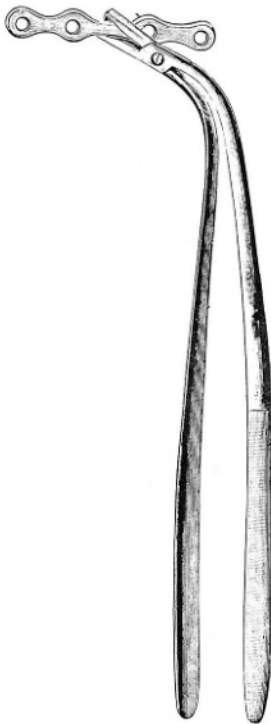

LANE
 26.0144.22
 22.0cm

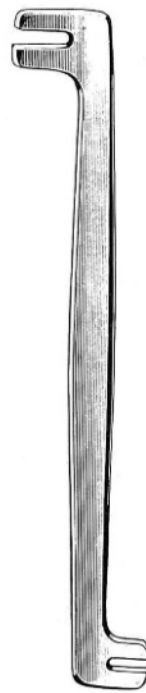

LANE
 26.0150.18
 18.0cm



26.0154.25
 25.5cm

26.0154.25

26-007

www.hilbro.net

BONE SURGERY

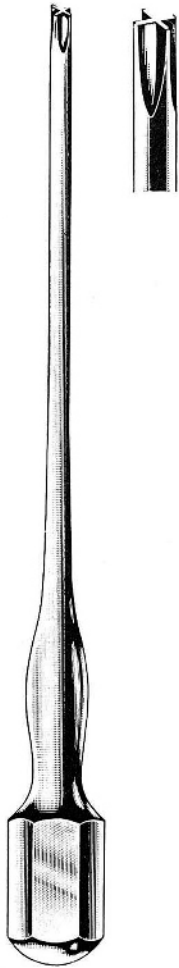

26.0160.25 25.0cm

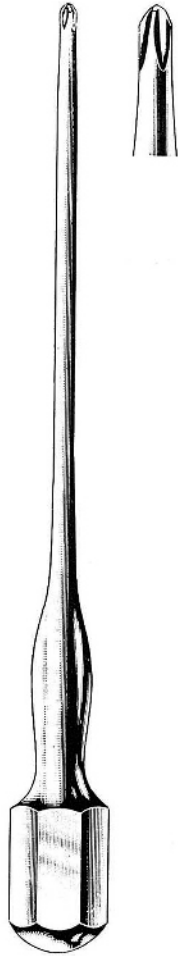

PHILLIPS
26.0164.25 25.0cm



LANE
26.0170.17 17.0cm
26.0170.25 25.0cm

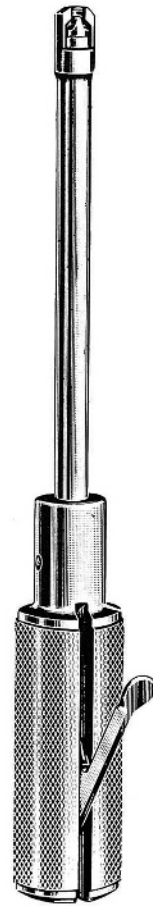

WILLIAMS
26.0174.24 24.0cm

26.0174.24

26-008

www.hilbro.net

Screw Drivers EN

Schraubenzieher DE

Destornilladores ES

26

BONE SURGERY



26.0180.25 2.5mm
26.0180.35 3.5mm
26.0180.45 4.5mm
25.0cm



PHILLIPS
26.0184.25 25.0cm



26.0190.25 25.0cm



LANE
26.0194.17 17.0cm
26.0194.25 25.0cm

26.0194.25

26-009

www.hilbro.net

26

- EN Screw Driver set in case
- DE Schraubenzicher-set mit-Etui
- ES Juego de destornilladores en esuche



BONE SURGERY



1/2
26.0200.14 14.5cm



1/4
26.0200.13



26.0200.00 Screw driver set, complete in case
26.0200.01 Sterilizing case only



1/4
26.0200.02

-



1/4
26.0200.03

+



1/4
26.0200.04

+



1/4
26.0200.05

+

2.5mm



1/4
26.0200.06
26.0200.07

3.5mm



26.0200.07

26-010

www.hilbro.net

BONE SURGERY



26.0210.24
2.4mm



26.0210.32
3.2mm



26.0210.48
4.8mm



26.0210.64
6.4mm

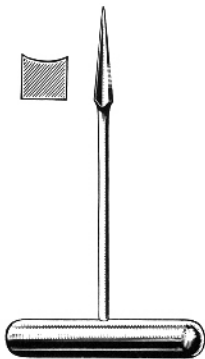

26.0220.14 14.0cm



26.0222.14 14.0cm



PERTHES
26.0224.21 21.0mm

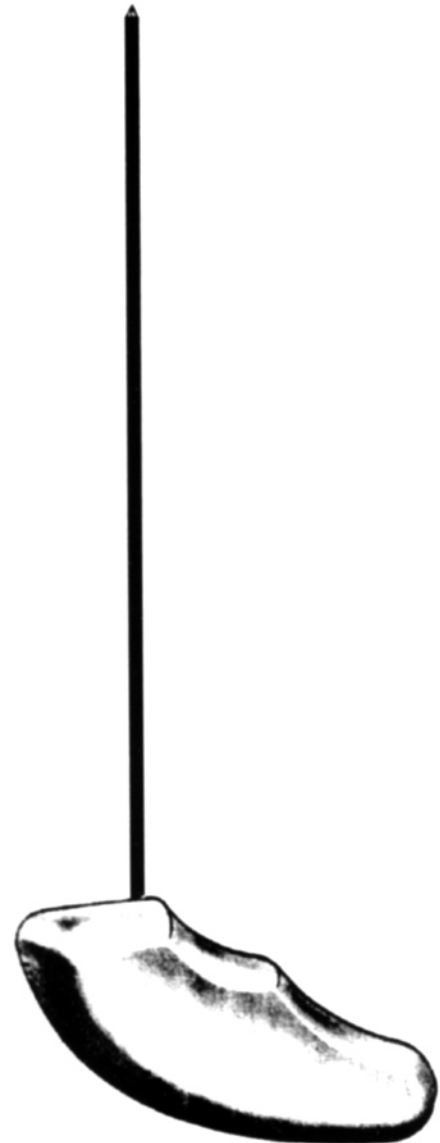

26.0226.24 2.4mm
 26.0226.32 3.2mm
 26.0226.48 4.8mm
 26.0226.64 6.4mm

26.0226.64

26-011

www.hilbro.net

EN Flat Nose Pliers, Wire Cutting Pliers, Seizing Forceps

DE Flachzangen, Draht-kheifzangen, Faßzangen

ES Alicates planos, alicates para cortar alambre, pinzas para coger



BONE SURGERY



26.0230.16 16.5cm

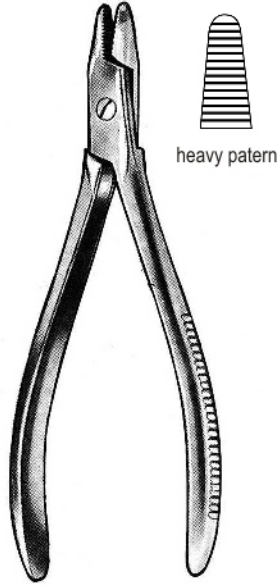

26.0232.16 16.0cm



26.0236.15 15.0cm



26.0240.17 17.0cm



26.0242.18 18.0cm



26.0244.18 18.0cm

26.0244.18

26-012

www.hilbro.net

Flat Nose Pliers EN

Flachzangen DE

Alicates planos ES

26

BONE SURGERY



17.0cm



26.0250.01

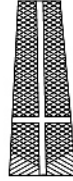

26.0250.02



18.0cm



26.0254.01



26.0254.02



26.0254.03

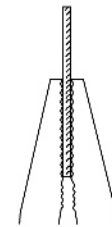

parallel action



14.0cm



26.0258.01



26.0258.02



26.0262.16 16.0cm

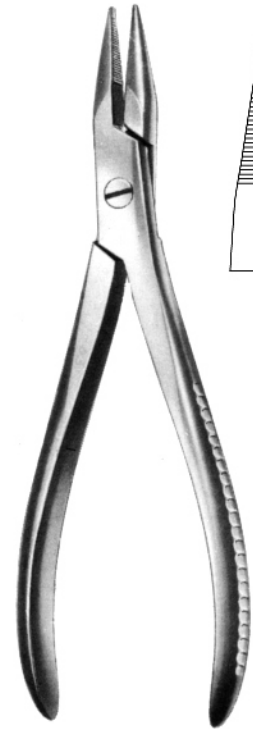
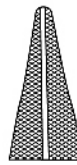

26.0266.19 19.5cm

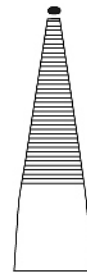

26.0266.19

26-013

www.hilbro.net

BONE SURGERY



PARHAM

26.0270.18 18.0cm
 26.0270.20 20.0cm
 26.0270.25 25.0cm
 26.0270.30 30.0cm



PARHAM

26.0274.22 22.0cm

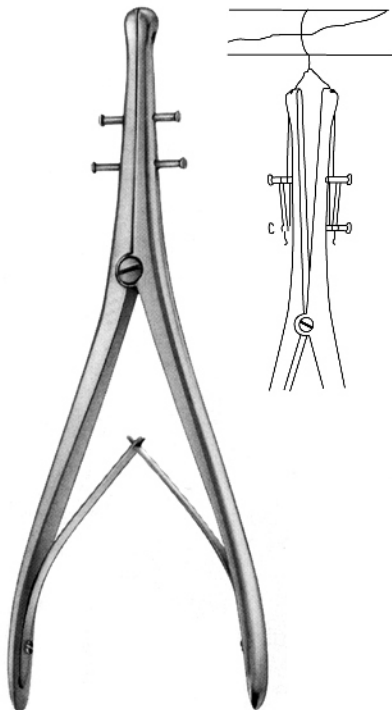

DEMEL

26.0280.28 28.0cm

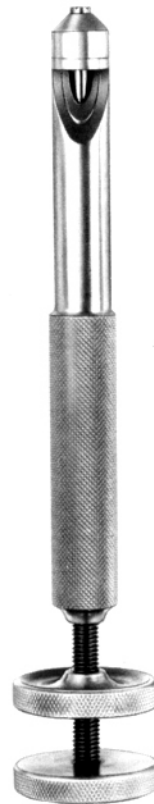

LOUTE

26.0284.21 21.0cm

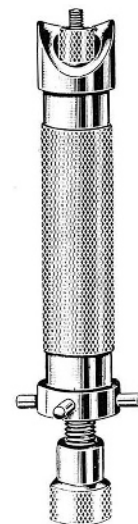

LLOYD

26.0288.00

26.0288.00

26-014

www.hilbro.net

BONE SURGERY



| | soft | hard |
|---------|------------|------------|
| 0.2mm Ø | 26.0290.02 | |
| 0.3mm Ø | 26.0290.03 | 26.0292.03 |
| 0.4mm Ø | 26.0290.04 | 26.0292.04 |
| 0.5mm Ø | 26.0290.05 | |
| 0.6mm Ø | 26.0290.06 | 26.0292.06 |
| 0.7mm Ø | 26.0290.07 | |
| 0.8mm Ø | 26.0290.08 | 26.0292.08 |
| 0.9mm Ø | 26.0290.09 | |
| 1.0mm Ø | 26.0290.10 | 26.0292.10 |
| 1.2mm Ø | 26.0290.12 | |
| 1.5mm Ø | 26.0290.15 | |

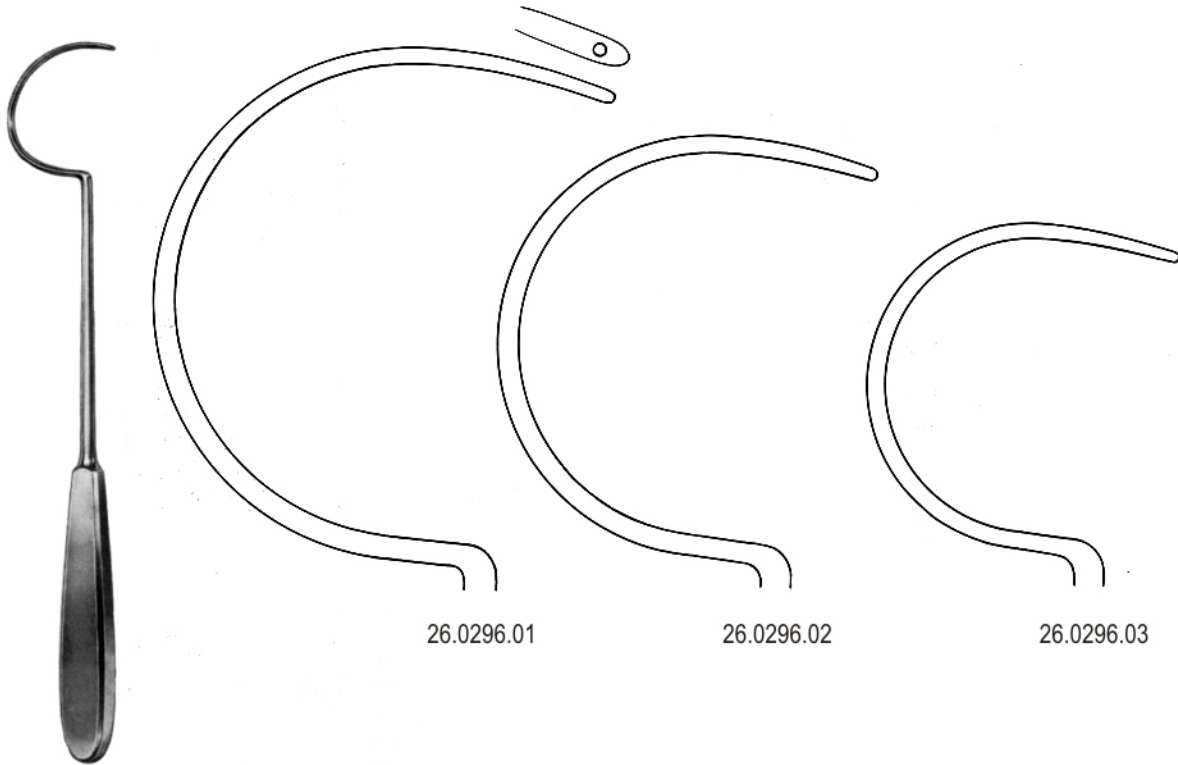

DEMEL

26.0296.01

26.0296.02

26.0296.03

26.0296.03

26-015

www.hilbro.net



KUENTSCHER
 26.0304.21 21.0cm



KUENTSCHER
 26.0306.21 21.0cm



KUENTSCHER
 26.0310.00 63.0cm
 complete set



26.0310.01 26.0310.02

26.0310.03 26.0310.04

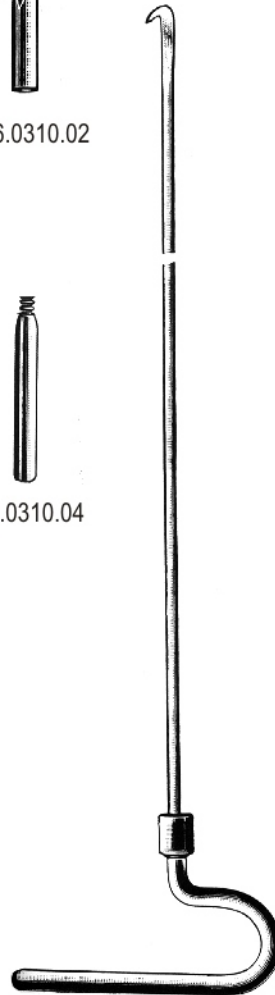

26.0314.29 29.0cm
 26.0314.37 37.0cm
 26.0314.42 42.0cm
 26.0314.49 49.0cm

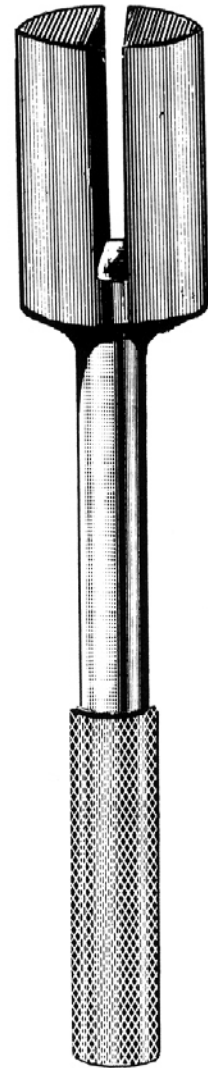

26.0320.00

BONE SURGERY



| | L=35cm | L=46cm | L=60cm |
|---------|------------|------------|------------|
| 2.5mm Ø | 26.0330.25 | 26.0332.25 | |
| 3.0mm Ø | 26.0330.30 | 26.0332.30 | |
| 3.5mm Ø | 26.0330.35 | 26.0332.35 | 26.0334.35 |
| 4.0mm Ø | 26.0330.40 | 26.0332.40 | 26.0334.40 |
| 5.0mm Ø | 26.0330.50 | 26.0332.50 | 26.0334.50 |



KUENTSCHER
26.0340.26 26.0cm

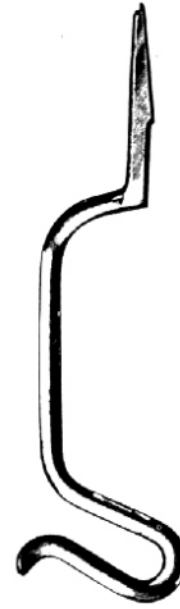

KUENTSCHER
26.0344.35 35.0cm



STEINMANN
4mm Ø (Trocar tip)
26.0360.14 140mm
26.0360.16 160mm
26.0360.18 180mm
26.0360.20 200mm



SCHANZ
4mm Ø (Flat tip)
26.0364.06 60mm
26.0364.08 80mm
26.0364.10 100mm



SCHANZ
6mm Ø (Flat tip)
26.0366.10 100mm
26.0366.13 130mm
26.0366.16 160mm
26.0366.19 190mm



SCHANZ
5mm Ø (Trocar tip)
26.0368.10 100mm
26.0368.12 125mm
26.0368.15 150mm
26.0368.17 170mm
26.0368.20 200mm
26.0368.25 250mm

26.0368.25

26-017

www.hilbro.net

26

EN Steinmann Pins

DE Steinmann Nagel

ES Calvos segun steinmann

BONE SURGERY

KIRSCHNER

trocar point
flat end



| mm ø | 60 mm | 120mm | 140mm | 160mm | 310mm |
|------|------------|------------|------------|------------|------------|
| 0.6 | 26.0380.06 | | | | |
| 0.8 | 26.0380.08 | | | | |
| 1.0 | 26.0380.10 | 26.0382.10 | 26.0384.10 | 26.0386.10 | 26.0388.10 |
| 1.2 | 26.0380.12 | 26.0382.12 | 26.0384.12 | 26.0386.12 | 26.0388.12 |
| 1.4 | 26.0380.14 | 26.0382.14 | 26.0384.14 | 26.0386.14 | 26.0388.14 |
| 1.5 | 26.0380.15 | 26.0382.15 | 26.0384.15 | 26.0386.15 | 26.0388.15 |
| 1.6 | 26.0380.16 | 26.0382.16 | 26.0384.16 | 26.0386.16 | 26.0388.16 |
| 1.8 | 26.0380.18 | 26.0382.18 | 26.0384.18 | 26.0386.18 | 26.0388.18 |
| 2.0 | 26.0380.20 | 26.0382.20 | 26.0384.20 | 26.0386.20 | 26.0388.20 |
| 2.2 | 26.0380.22 | 26.0382.22 | 26.0384.22 | 26.0386.22 | 26.0388.22 |
| 2.5 | 26.0380.25 | 26.0382.25 | 26.0384.25 | 26.0386.25 | 26.0388.25 |

KIRSCHNER

trocar point
round end



| mm ø | 60 mm | 120mm | 140mm | 160mm | 310mm |
|------|------------|------------|------------|------------|------------|
| 1.0 | 26.0390.10 | 26.0392.10 | 26.0394.10 | 26.0396.10 | 26.0398.10 |
| 1.2 | 26.0390.12 | 26.0392.12 | 26.0394.12 | 26.0396.12 | 26.0398.12 |
| 1.4 | 26.0390.14 | 26.0392.14 | 26.0394.14 | 26.0396.14 | 26.0398.14 |
| 1.5 | 26.0390.15 | 26.0392.15 | 26.0394.15 | 26.0396.15 | 26.0398.15 |
| 1.6 | 26.0390.16 | 26.0392.16 | 26.0394.16 | 26.0396.16 | 26.0398.16 |
| 1.8 | 26.0390.18 | 26.0392.18 | 26.0394.18 | 26.0396.18 | 26.0398.18 |
| 2.0 | 26.0390.20 | 26.0392.20 | 26.0394.20 | 26.0396.20 | 26.0398.20 |
| 2.2 | 26.0390.22 | 26.0392.22 | 26.0394.22 | 26.0396.22 | 26.0398.22 |
| 2.5 | 26.0390.25 | 26.0392.25 | 26.0394.25 | 26.0396.25 | 26.0398.25 |

KIRSCHNER

lancet point
flat end

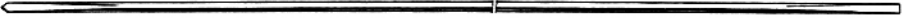

| mm ø | 100 mm |
|------|------------|
| 1.0 | 26.0400.10 |
| 1.2 | 26.0400.12 |
| 1.5 | 26.0400.15 |
| 1.6 | 26.0400.16 |
| 1.8 | 26.0400.18 |
| 2.0 | 26.0400.20 |
| 2.2 | 26.0400.22 |
| 2.5 | 26.0400.25 |

26.0400.25

26-018

www.hilbro.net

BONE SURGERY

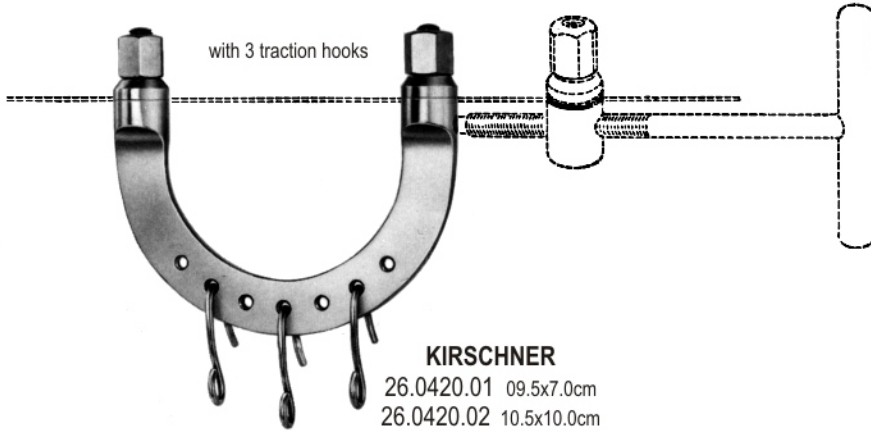

KIRSCHNER
 26.0420.01 09.5x7.0cm
 26.0420.02 10.5x10.0cm
 26.0420.03 12.0x12.0cm
 26.0420.04 15.5x15.5cm
 26.0420.05 20.0x15.5cm



KIRSCHNER
 26.0424.01 6.0x6.0cm

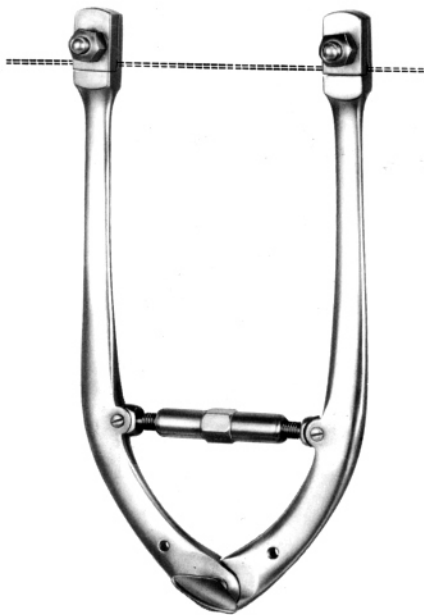

26.0430.18 18.0x10.0cm
 26.0430.27 27.0x27.0cm

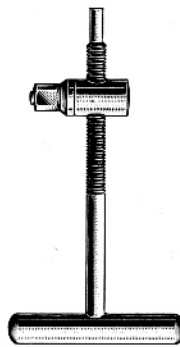

26.0434.18



26.0440.19 19.0cm



26.0444.03 26.0444.06

26.0444.06

26-019

www.hilbro.net

BONE SURGERY

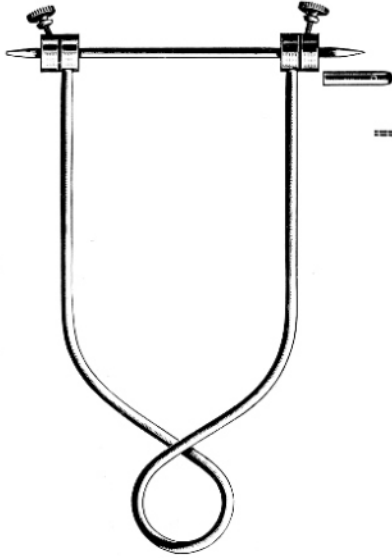

BÖHLER

26.0450.15 21.0x15.0cm
 26.0450.16 16.0x 9.0cm
 26.0450.21 21.0x11.0cm



KIRSCHNER

26.0454.01 13.5cm, infant
 26.0454.02 18.5cm, child
 26.0454.03 27.0cm, adult



MARTIN-DIAMANT

26.0460.16
 16.0cm



26.0464.16
 16.0cm



26.0470.15
 15.0cm



26.0474.23
 23.0cm



26.0474.25
 25.0cm



26.0480.24
 24.0cm

26.0480.24

26-020

www.hilbro.net