

CARDIO- VASCULAR

34

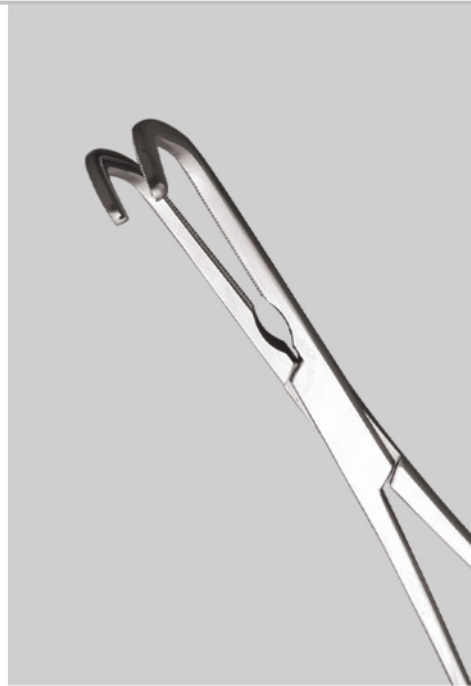

PAGE 001 to 050

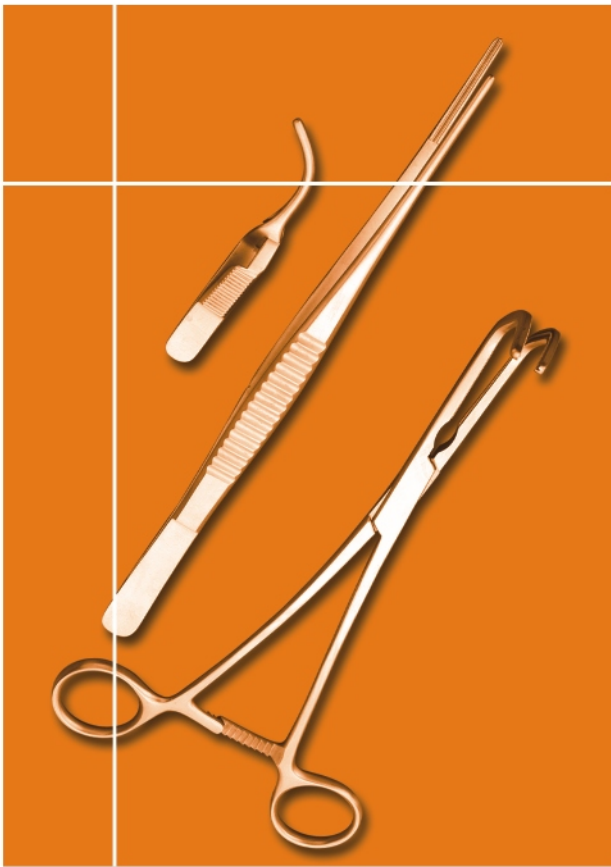

EN Cardiovascular Surgery

DE Herz-und Gefäßchirurgie

ES Cirugia Cardiovascular

SERVING HEALTHCARE WORLDWIDE

www.hilbro.net



CARDIOVASCULAR

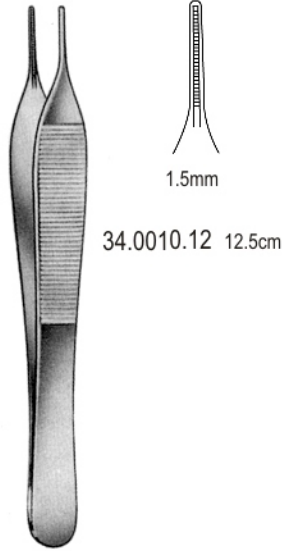

34.0010.12 12.5cm

DEBAKEY-ADSON



34.0014.15 15.0cm
34.0014.18 18.0cm

DEBAKEY-GERALD

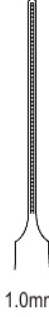

1.0mm

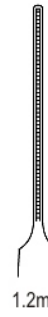

1.2mm

34.0016.15 15.0cm
34.0016.18 18.0cm
34.0016.24 24.0cm

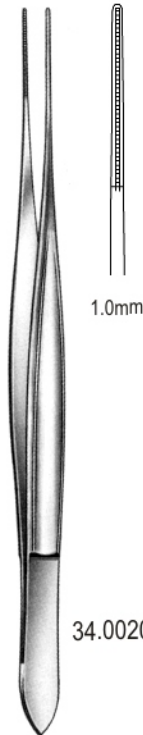

1.0mm

34.0020.18 18.0cm

DEBAKEY-CUSHING



1.0mm

34.0024.15 15.0cm 34.0026.15
34.0024.19 19.0cm 34.0026.19
34.0024.24 24.0cm 34.0026.24

DEBAKEY-DIETRICH

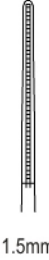

1.5mm



1.0mm

34.0030.15 15.0cm
34.0030.19 19.0cm
34.0030.24 24.0cm

DEBAKEY-LIGHT

34.0030.24

34-001

www.hilbro.net



CARDIOVASCULAR

ALSO AVAILABLE IN TITANIUM

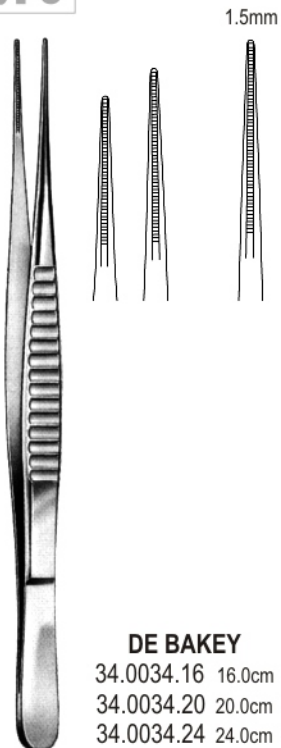

DE BAKEY
 34.0034.16 16.0cm
 34.0034.20 20.0cm
 34.0034.24 24.0cm
 34.0034.30 30.0cm

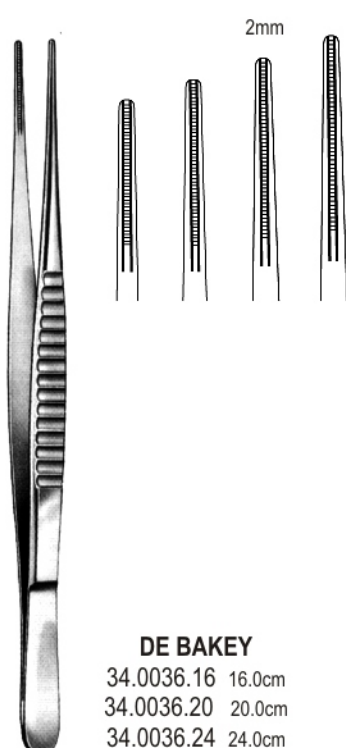

DE BAKEY
 34.0036.16 16.0cm
 34.0036.20 20.0cm
 34.0036.24 24.0cm
 34.0036.30 30.0cm

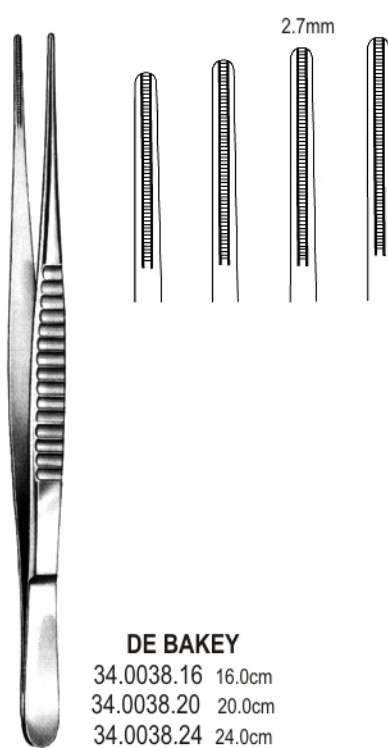

DE BAKEY
 34.0038.16 16.0cm
 34.0038.20 20.0cm
 34.0038.24 24.0cm
 34.0038.30 30.0cm

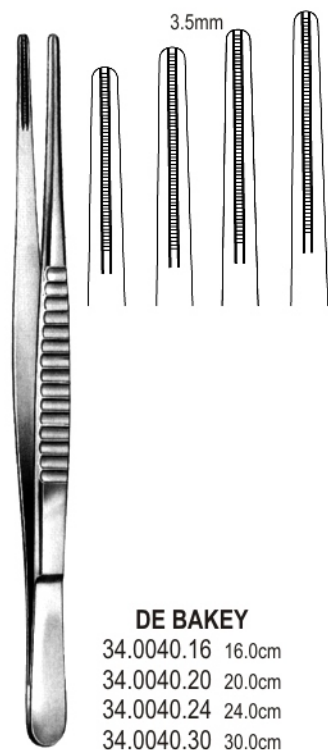

DE BAKEY
 34.0040.16 16.0cm
 34.0040.20 20.0cm
 34.0040.24 24.0cm
 34.0040.30 30.0cm

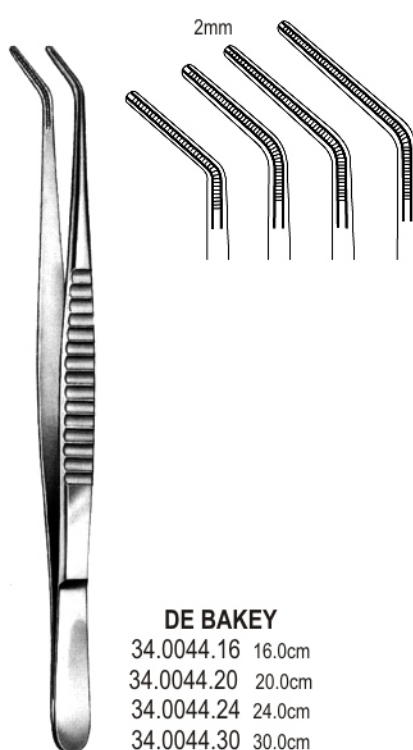

DE BAKEY
 34.0044.16 16.0cm
 34.0044.20 20.0cm
 34.0044.24 24.0cm
 34.0044.30 30.0cm



DE BAKEY
 34.0046.16 16.0cm
 34.0046.20 20.0cm
 34.0046.24 24.0cm
 34.0046.30 30.0cm

34.0046.30

34-002

www.hilbro.net

ALSO AVAILABLE IN TITANIUM

CARDIOVASCULAR



34.0050.03 3.5cm
34.0050.04 4.5cm



34.0051.03 3.5cm
34.0051.04 4.5cm



34.0053.03 3.5cm 34.0055.03 3.5cm

MINI-GLOVER

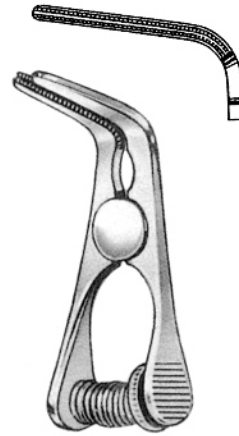

GLOVER
34.0060.05 5.0cm

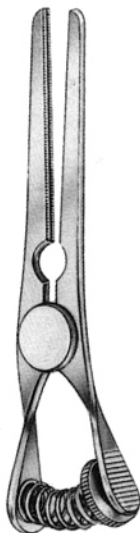

GLOVER
(DELICATE)



34.0064.05 5.0cm 34.0064.06 6.8cm 34.0064.08 8.5cm



34.0065.05 4.6cm 34.0065.06 6.4cm 34.0065.08 7.8cm

34.0065.08

34-003

www.hilbro.net

EN Atrauma Bulldog Clamps

DE Atrauma Bulldogklemmen

ES Atrauma clamps bulldog



CARDIOVASCULAR

ALSO AVAILABLE IN TITANIUM

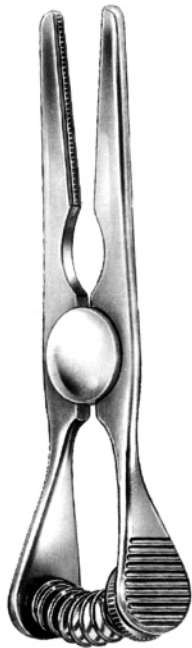

GLOVER



34.0070.07
7.0cm



34.0070.08
8.0cm



34.0070.09
9.0cm



34.0070.11
11.0cm



GLOVER



34.0071.06
6.0cm



34.0071.07
7.5cm



34.0071.08
8.5cm

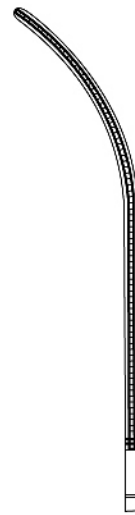

34.0071.11
10.5cm

34.0071.11

34-004

www.hilbro.net

ALSO AVAILABLE IN TITANIUM

CARDIOVASCULAR



DE BAKEY



34.0074.07
7.5cm



34.0074.08
8.5cm



34.0074.10
10.5cm

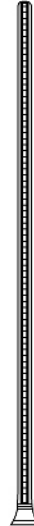

34.0074.12
12.0cm



DE BAKEY

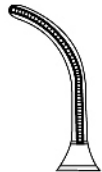

34.0075.07
7.0cm

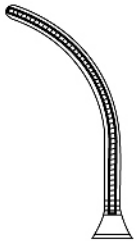

34.0075.08
8.0cm

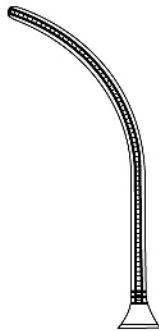

34.0075.10
10.0cm

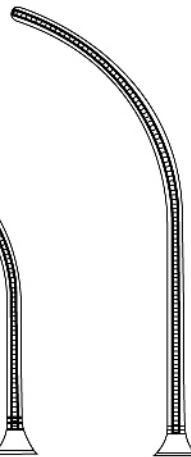

34.0075.11
11.5cm

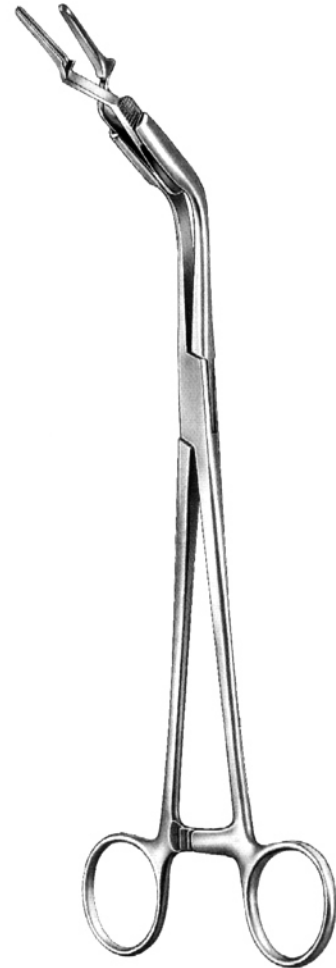

34.0080.23 23.0cm

34.0080.23

34-005

www.hilbro.net

EN Atrauma Bulldog Clamps

DE Atrauma Bulldogklemmen

ES Atrauma clamps bulldog



CARDIOVASCULAR

ALSO AVAILABLE IN TITANIUM



GREGORY SOFT

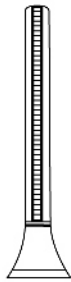

34.0084.09
9.0cm

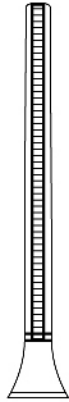

34.0084.11
11.0cm



GREGORY SOFT

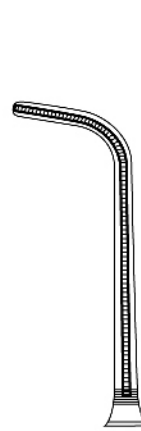

34.0085.09
9.0cm

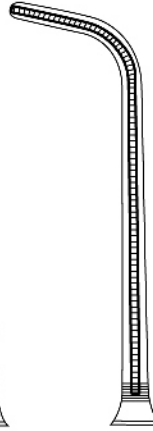

34.0085.11
11.0cm



34.0090.01

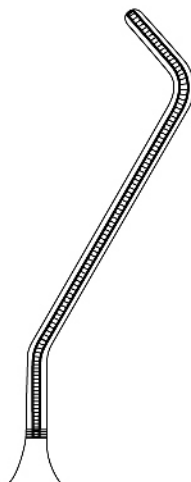

34.0090.02



SANTULLI
34.0094.07 7.0cm

34.0094.07

GREGORY SOFT
11.0cm

34-006

www.hilbro.net

Atrauma Bulldog Clamps EN

Atrauma Bulldogklemmen DE

Atrauma clamps bulldog ES

34

ALSO AVAILABLE IN TITANIUM

CARDIOVASCULAR

Hilbro



DE BAKEY-SATINSKY
34.0100.07 7.0cm

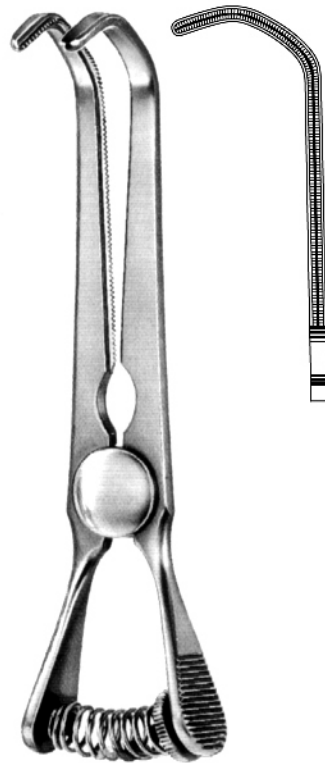

DE BAKEY-SATINSKY
34.0100.10 10.0cm

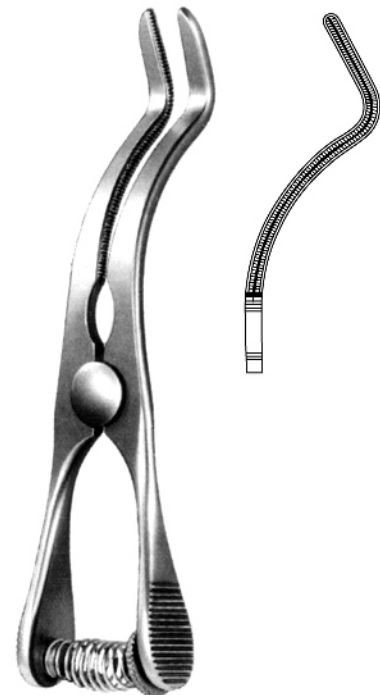

DE BAKEY-CAROTIS
34.0104.09 9.0cm

34.0104.09

34-007

www.hilbro.net

EN Atrauma Hemostatic Forceps

DE Atrauma Arterienklemmen

ES Atrauma hemostaticas pinzas



CARDIOVASCULAR

ALSO AVAILABLE IN TITANIUM

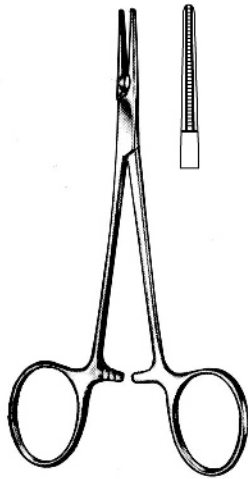

MOSQUITO
34.0110.12 12.0cm



MOSQUITO
34.0111.12 12.0cm

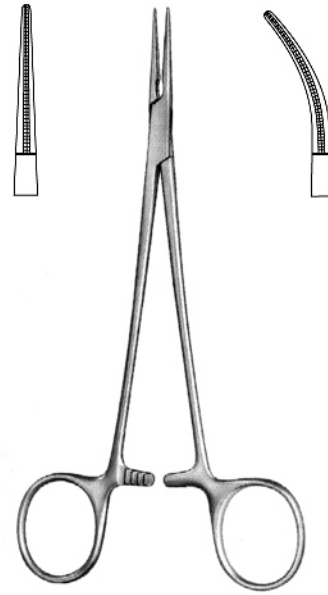

DE BAKEY-MOSQUITO
34.0120.15 15.0cm 34.0121.15

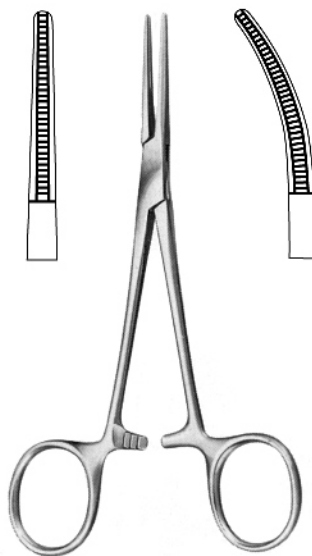

DE BAKEY-KELLY
34.0124.14 14.0cm 34.0125.14

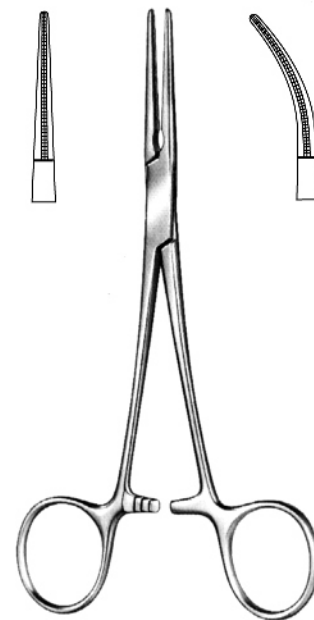

DE BAKEY-RAKIN
34.0130.16 16.0cm 34.0131.16

34.0131.16

34-008

www.hilbro.net

ALSO AVAILABLE IN TITANIUM

CARDIOVASCULAR



DE BAKEY
34.0134.10 10.0cm



DE BAKEY
34.0140.13 13.0cm

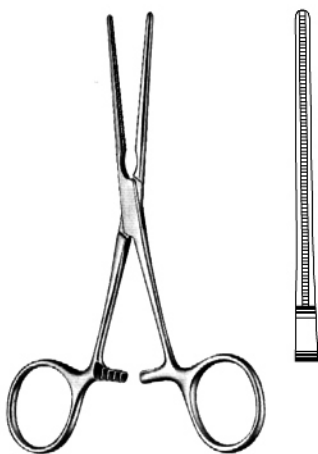

DE BAKEY
34.0150.12 12.0cm



DE BAKEY
34.0152.11 11.0cm

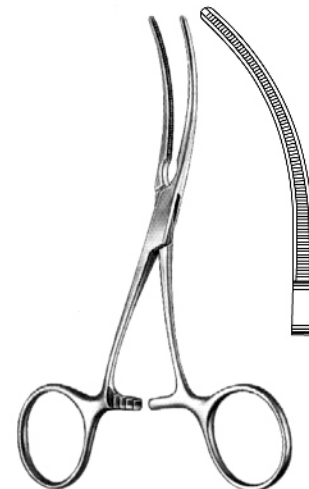

DE BAKEY
34.0154.12 12.0cm

34.0154.12

34-009

www.hilbro.net

34

EN Atrauma Cardiovascular Forceps

DE Atrauma Cardiovascular-Klemmen

ES Atrauma pinzas-clamps cardiovasculares

Hilbro

CARDIOVASCULAR

ALSO AVAILABLE IN TITANIUM



HUSFELDT
34.0160.17 17.0cm

HUSFELDT
34.0162.17 17.0cm

HUSFELDT
34.0164.18 18.0cm

34.0164.18

34-010

www.hilbro.net

ALSO AVAILABLE IN TITANIUM

CARDIOVASCULAR

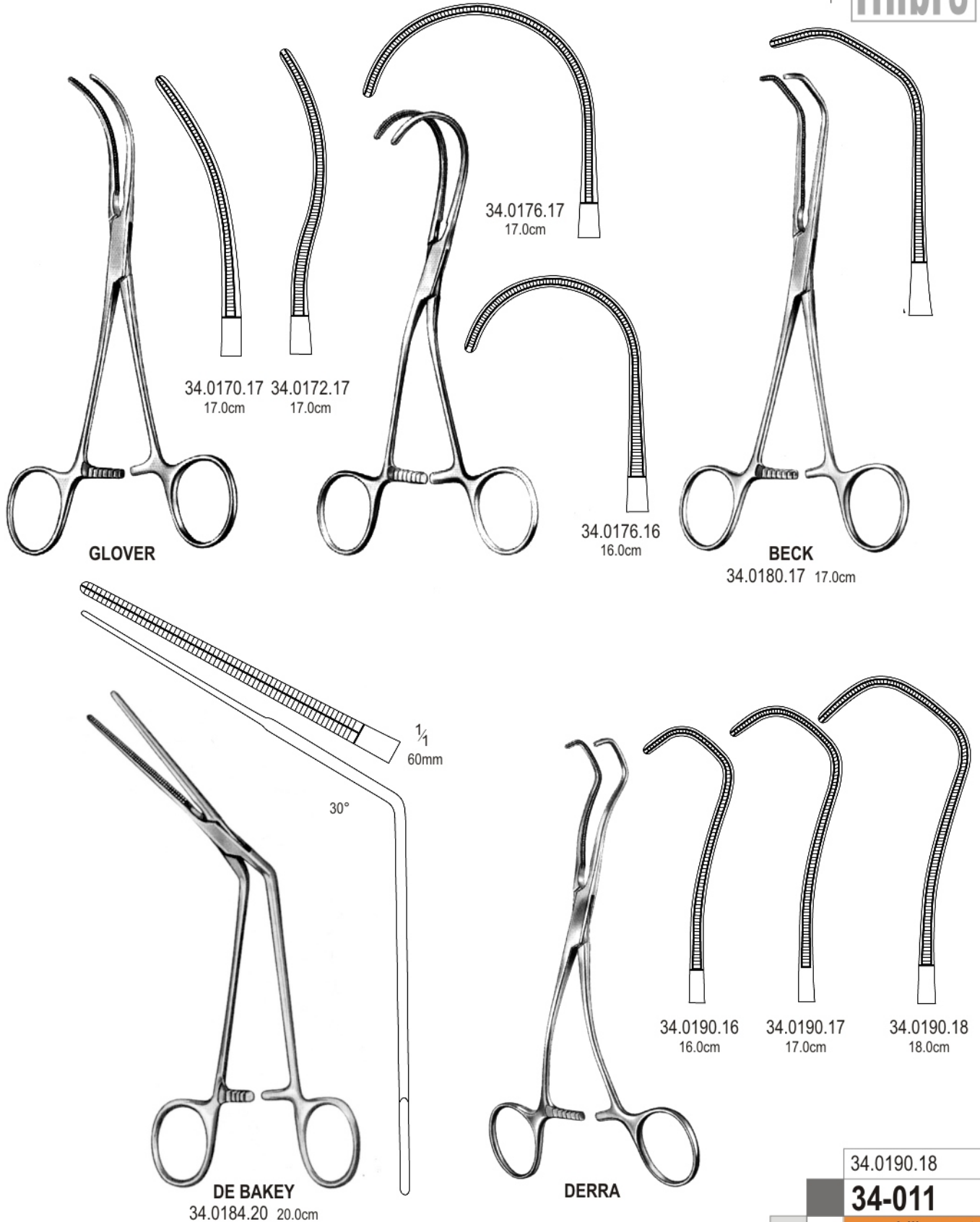

34.0190.18

34-011

www.hilbro.net

EN Atrauma Cardiovascular Forceps

DE Atrauma Cardiovascular-Klemmen

ES Atrauma pinzas-clamps cardiovasculares



CARDIOVASCULAR

ALSO AVAILABLE IN TITANIUM

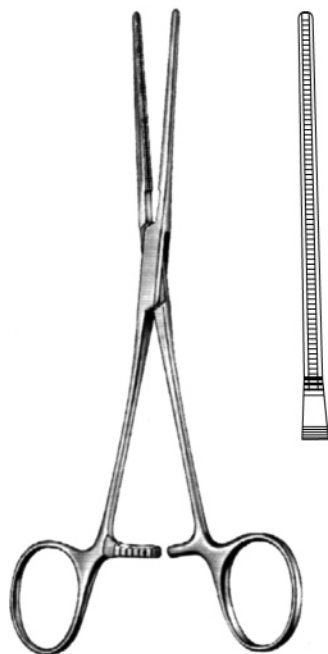

DE BAKEY
34.0194.17 17.0cm



DE BAKEY
34.0200.17 17.0cm

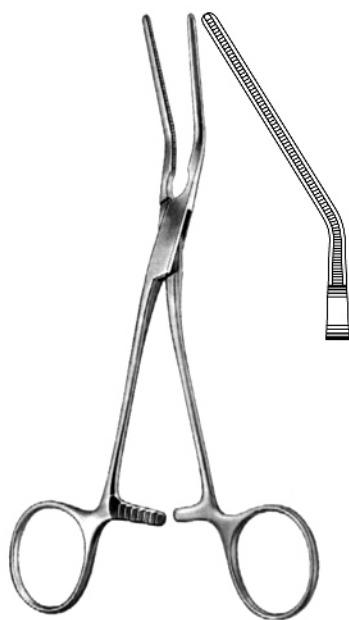

DE BAKEY
34.0204.16 16.0cm

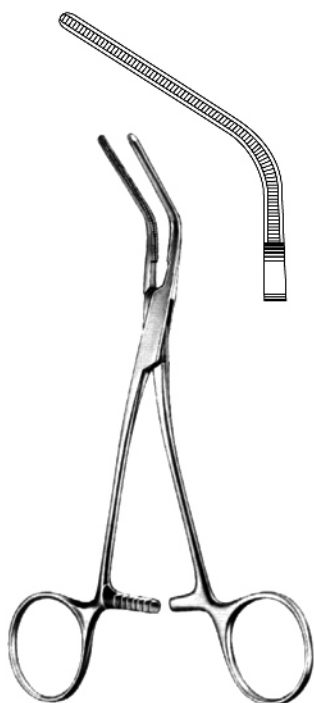

DE BAKEY
34.0210.15 15.0cm

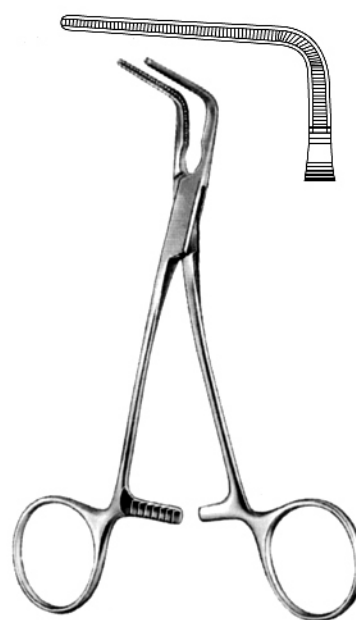

DE BAKEY
34.0214.15 15.0cm

34.0214.15

34-012

www.hilbro.net

Atrauma Hemostatic Forceps EN

Atrauma Arterienklemmen DE

Atrauma hemostaticas pinzas ES

34

ALSO AVAILABLE IN TITANIUM

CARDIOVASCULAR

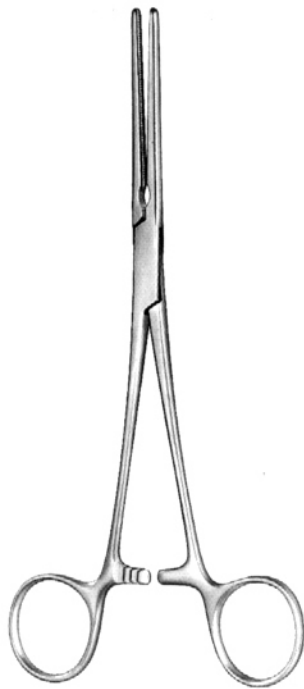

DE BAKEY-PEAN

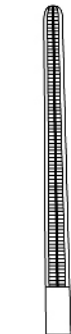

34.0220.14
14.0cm

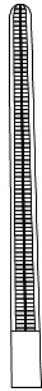

34.0220.16
16.0cm



34.0220.18
18.0cm

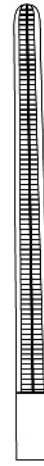

34.0220.20
20.0cm

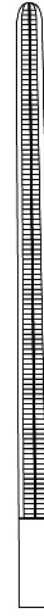

34.0220.26
26.0cm

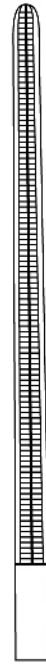

34.0220.28
28.0cm



DE BAKEY-PEAN

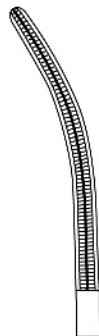

34.0221.14
14.0cm

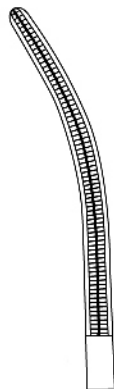

34.0221.16
16.0cm

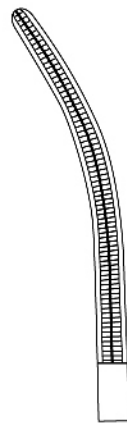

34.0221.18
18.0cm

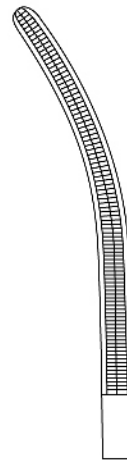

34.0221.20
20.0cm

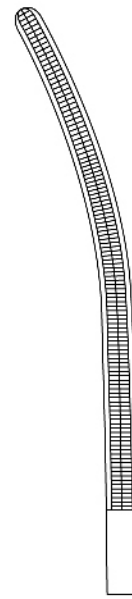

34.0221.26
26.0cm

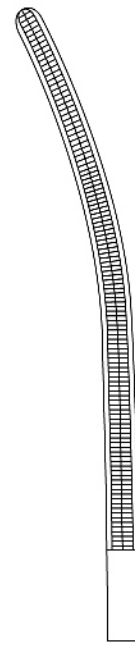

34.0221.28
28.0cm

34.0221.28

34-013

www.hilbro.net

EN Atrauma Cardiovascular Forceps

DE Atrauma Cardiovascular-Klemmen

ES Atrauma pinzas-clamps cardiovasculares

Hilbro

CARDIOVASCULAR

ALSO AVAILABLE IN TITANIUM

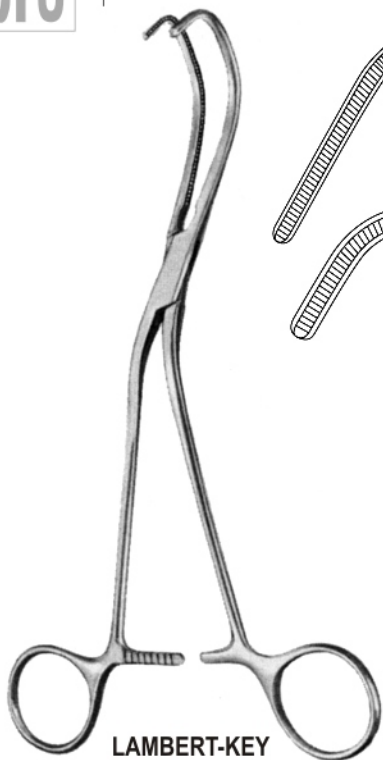

LAMBERT-KEY

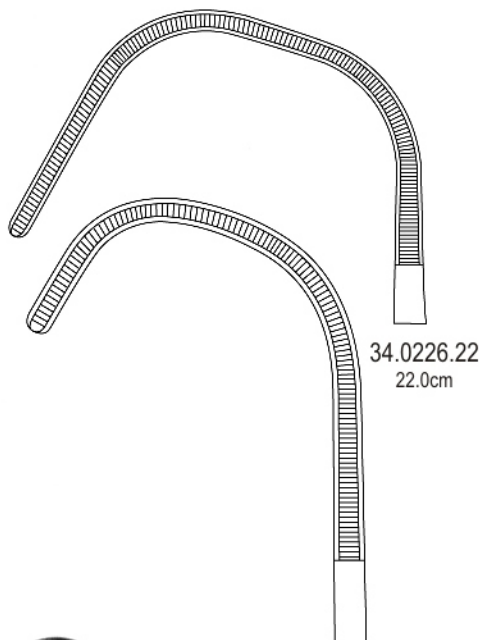

34.0226.22
22.0cm

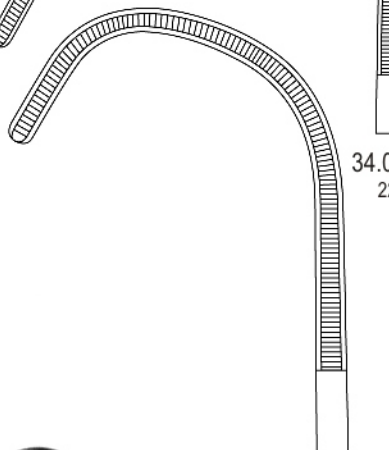

34.0226.21
21.0cm

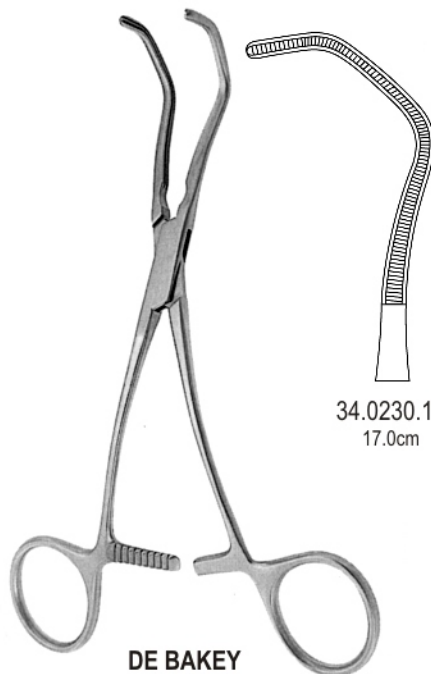

DE BAKEY

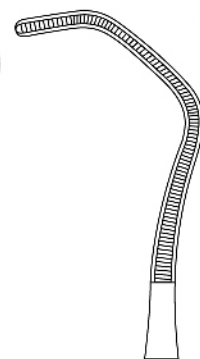

34.0230.17
17.0cm

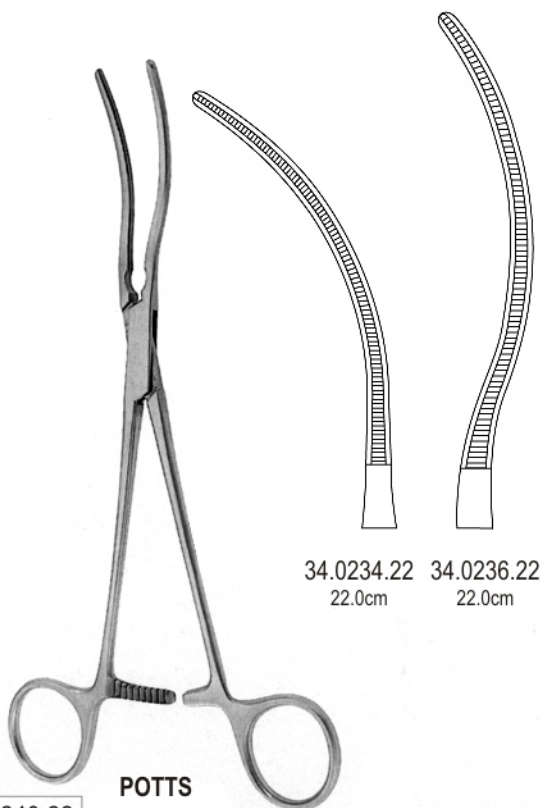

POTTS

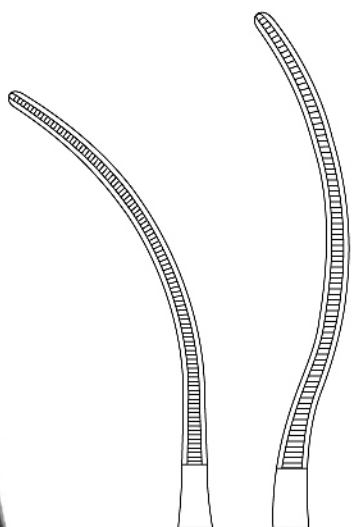

34.0234.22
22.0cm

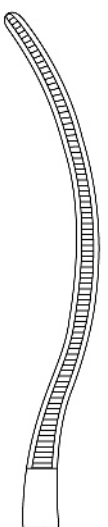

34.0236.22
22.0cm

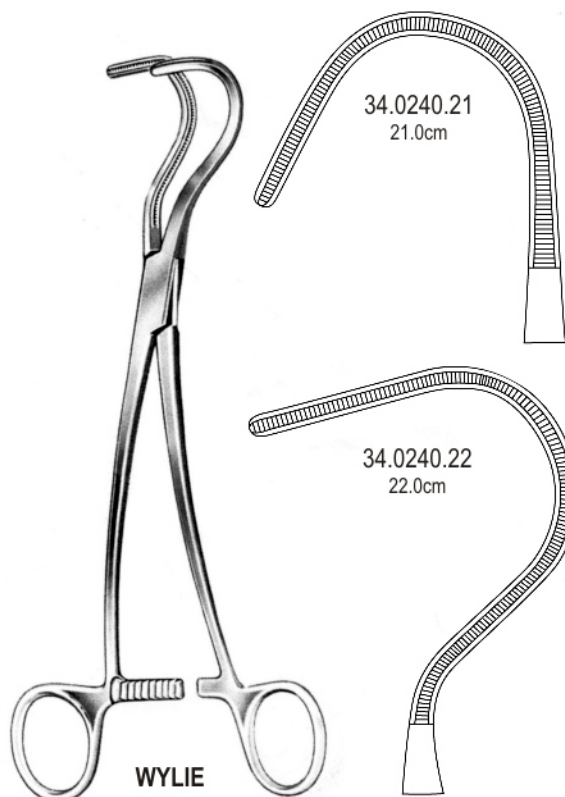

WYLIE

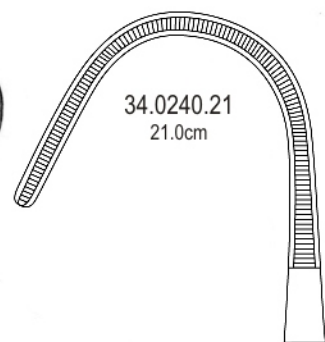

34.0240.21
21.0cm

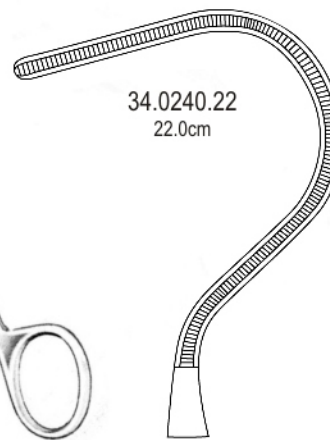

34.0240.22
22.0cm

34.0240.22

34-014

www.hilbro.net

ALSO AVAILABLE IN TITANIUM

CARDIOVASCULAR

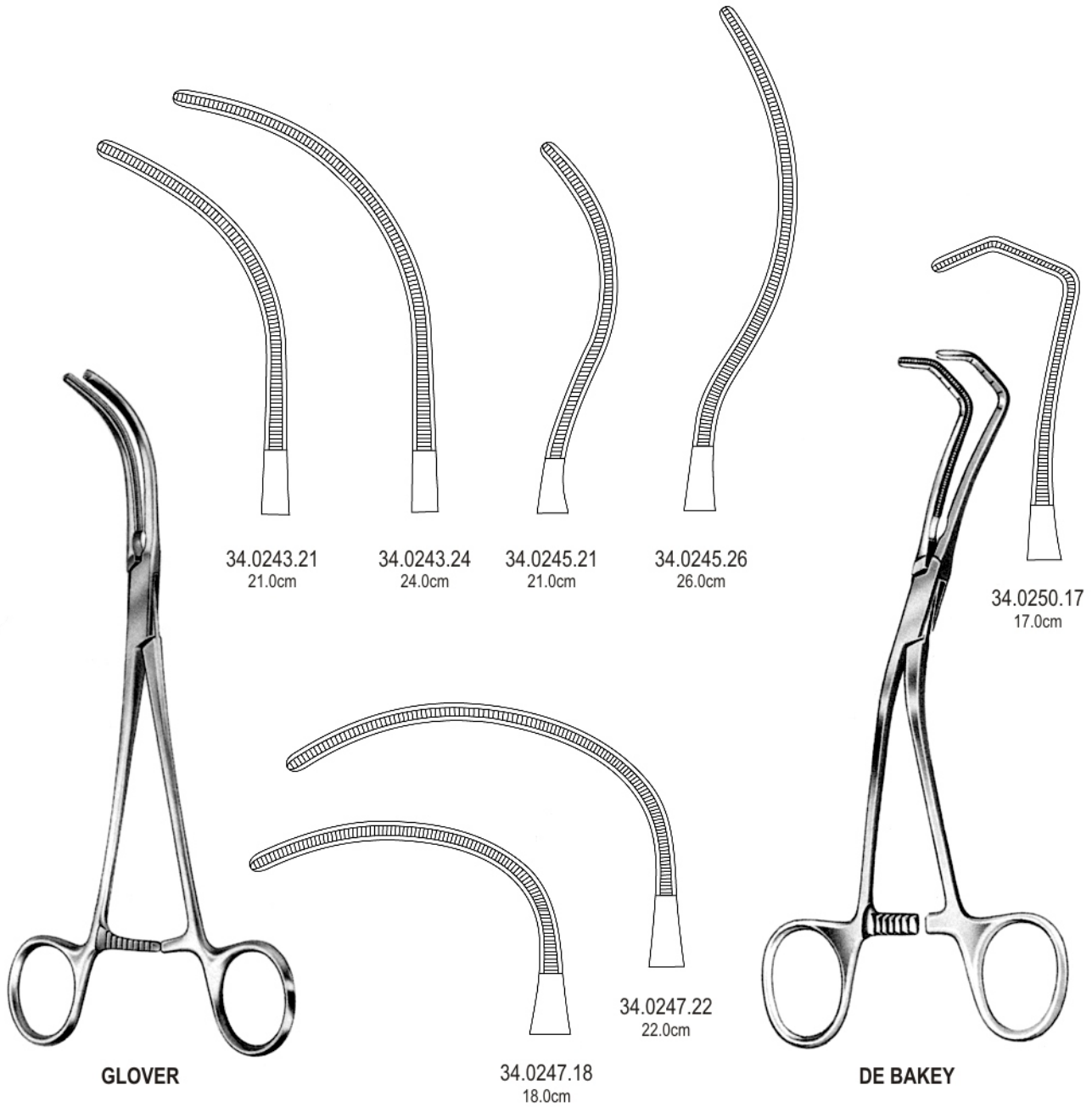

34.0250.17

34-015

www.hilbro.net

CARDIOVASCULAR

ALSO AVAILABLE IN TITANIUM



DE BAKEY-REYNOLDS

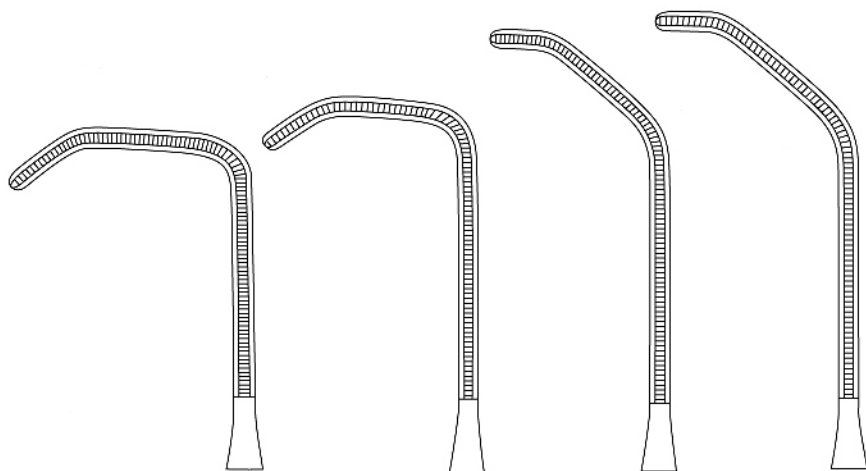

34.0254.16
16.5cm

34.0256.16
16.5cm

34.0254.18
18.0cm

34.0256.18
18.0cm

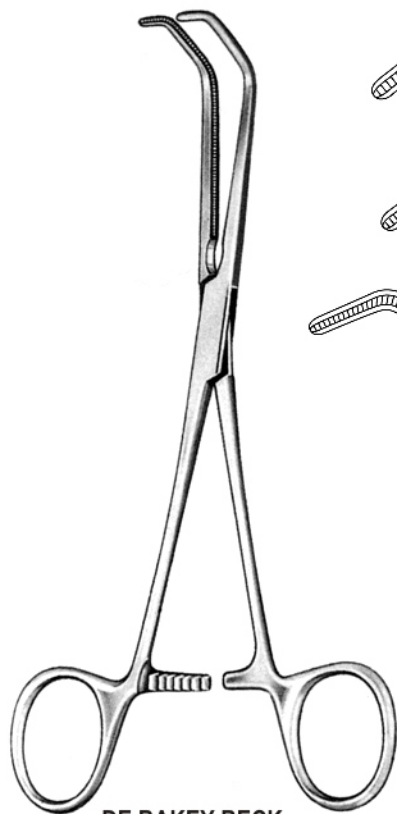

DE BAKEY-BECK

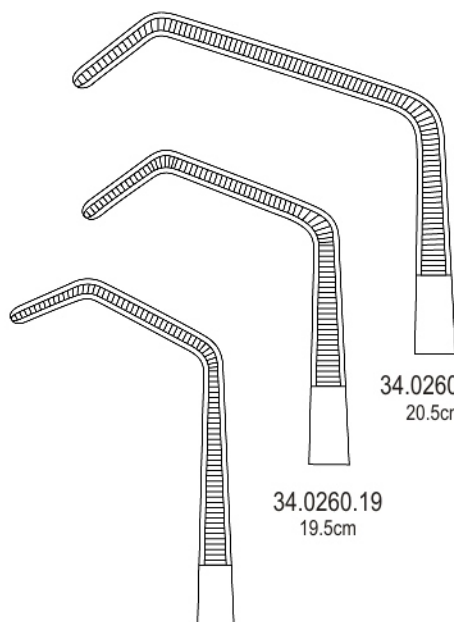

34.0260.16
16.5cm

34.0260.19
19.5cm

34.0260.20
20.5cm

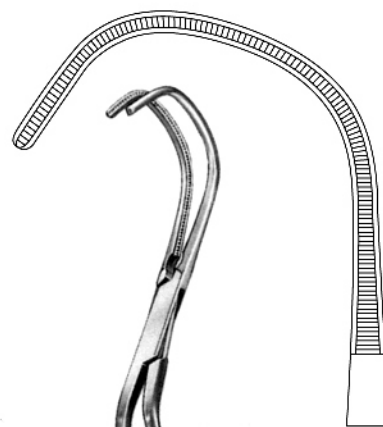

LIDDLE

34.0264.27
27.0cm

34.0264.27

34-016

www.hilbro.net

ALSO AVAILABLE IN TITANIUM

CARDIOVASCULAR

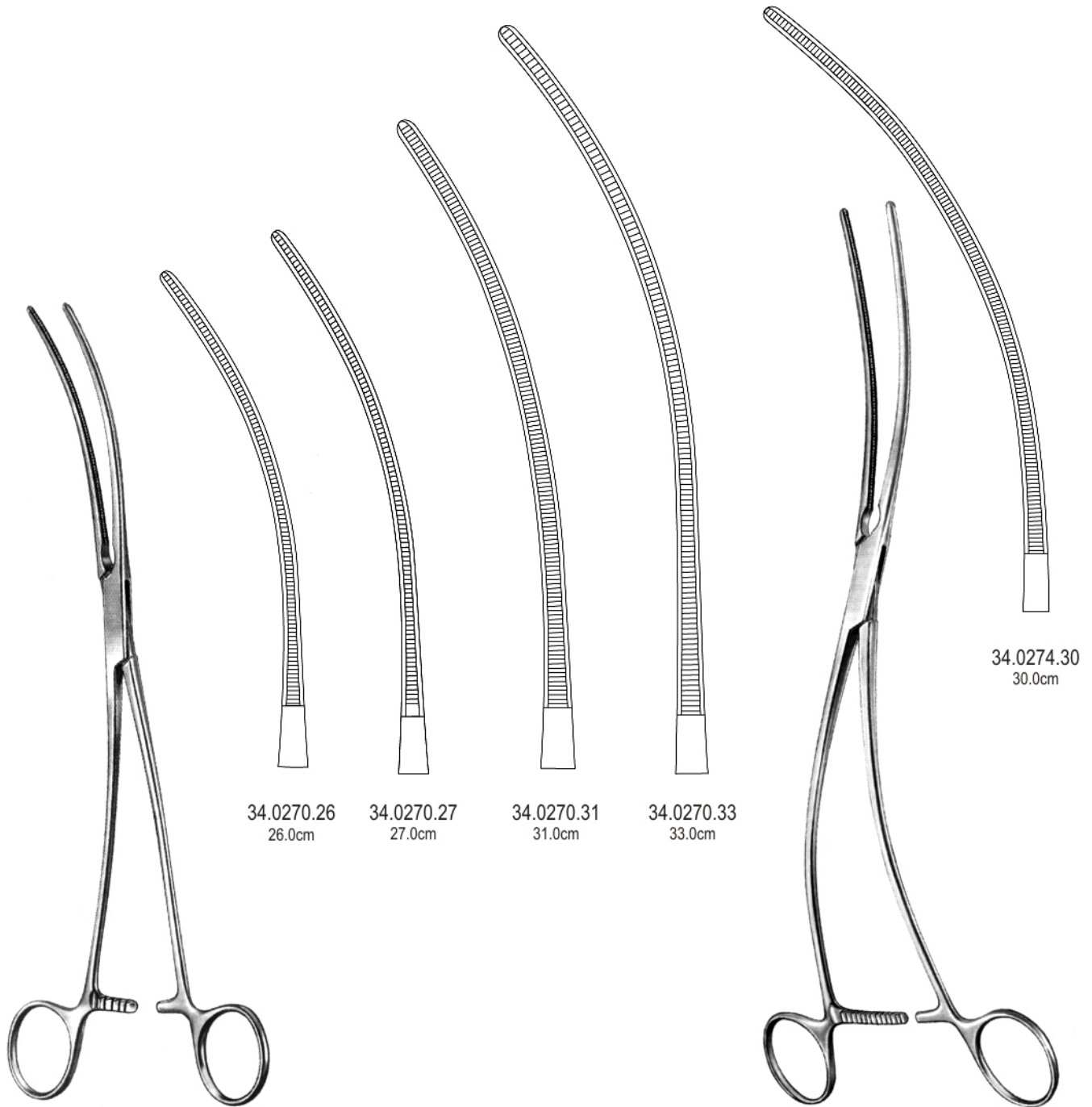

34

- EN Aortic Aneurysm Clamps
- DE Aorta-Aneurysmaklemmen
- ES Pinzas-clamps para aneurisma

Hilbro

CARDIOVASCULAR

ALSO AVAILABLE IN TITANIUM

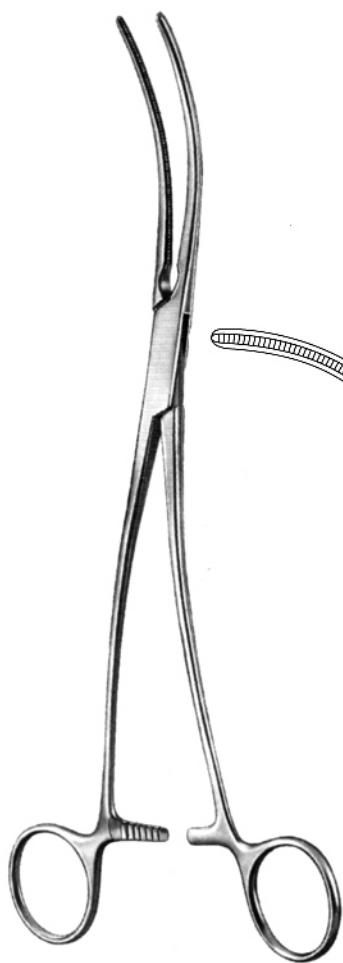

DE BAKEY-BAHNSON

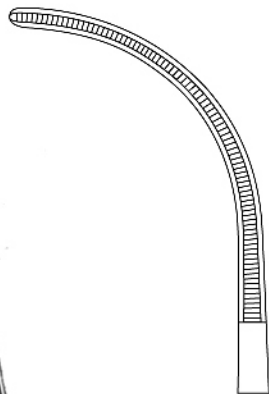

34.0280.23
23.0cm

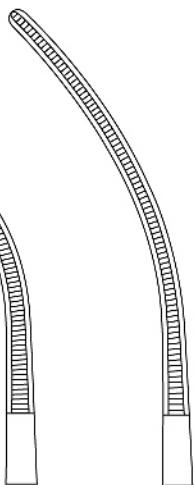

34.0280.24
24.0cm

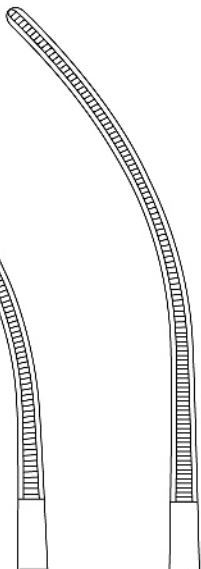

34.0280.25
25.0cm

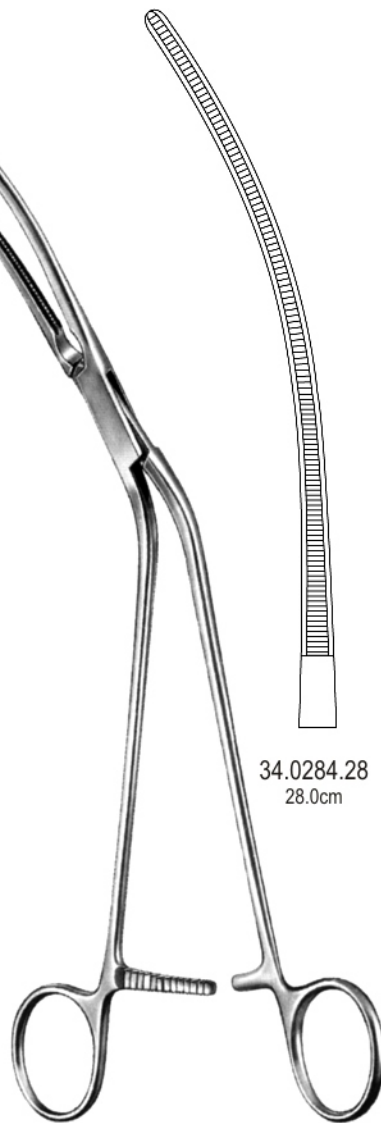

DE BAKEY

34.0284.28
28.0cm

34.0284.28

34-018

www.hilbro.net

Aortic Clamps EN

Aortaklemmen DE

Pinzas-clamps para aorta ES

34

ALSO AVAILABLE IN TITANIUM

CARDIOVASCULAR

Hilbro



OCHSNER
34.0290.23 23.5cm
34.0290.26 26.0cm

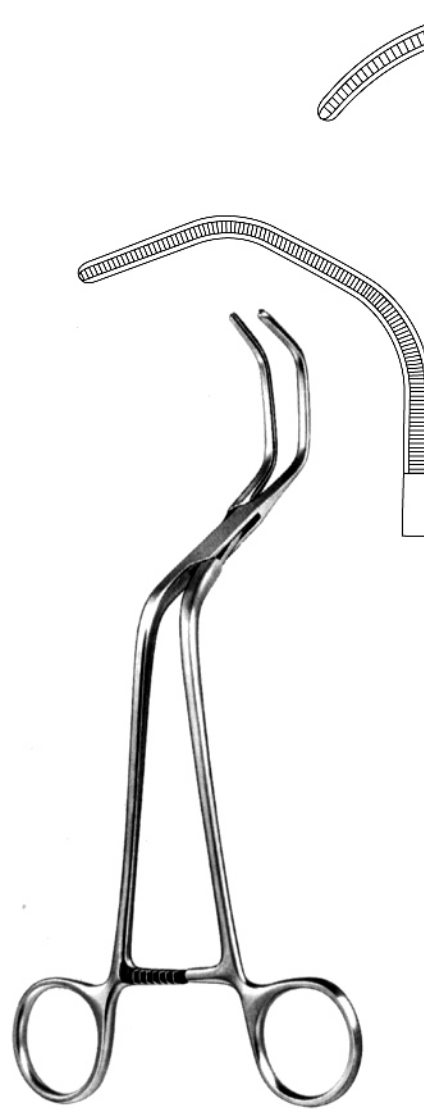

DIETRICH
34.0294.21 21.0cm

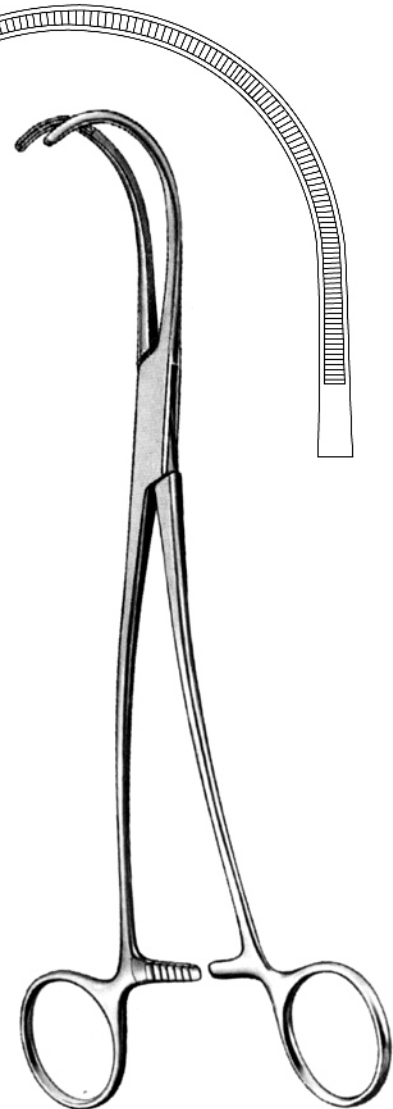

DE BAKAY
34.0300.26 26.0cm

34.0300.26

34-019

www.hilbro.net

EN Aortic Clamps

DE Aortaklemmen

ES Piznas-clamps para aorta



CARDIOVASCULAR

ALSO AVAILABLE IN TITANIUM

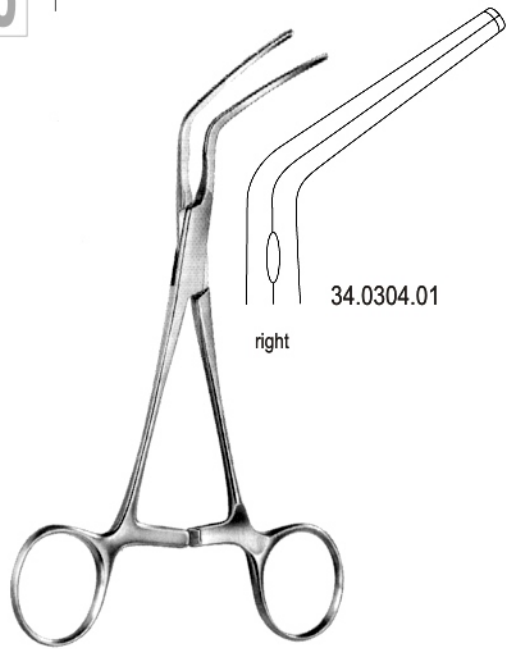

34.0304.01

right

SUBRAMANIAN

16.0cm

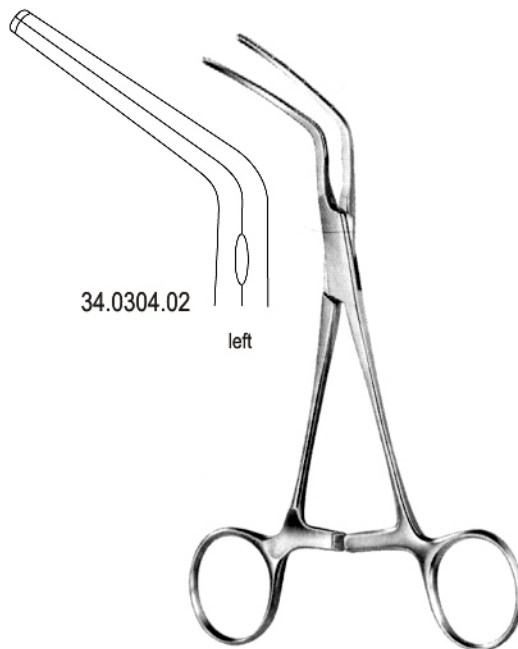

34.0304.02

left

SUBRAMANIAN

16.0cm

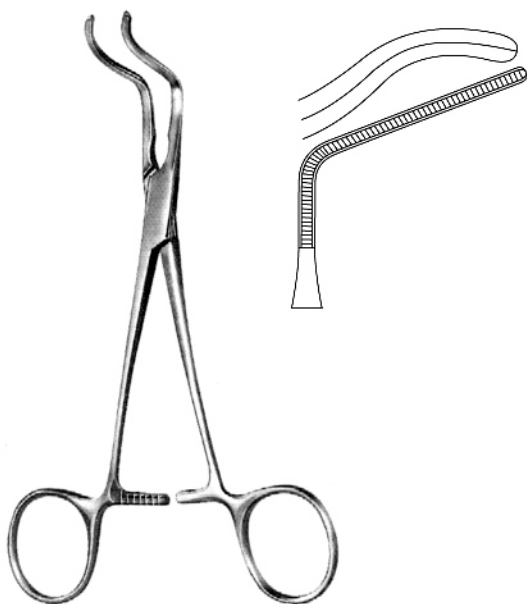

SUBRAMANIAN-MINIATURE

34.0310.15 15.5cm

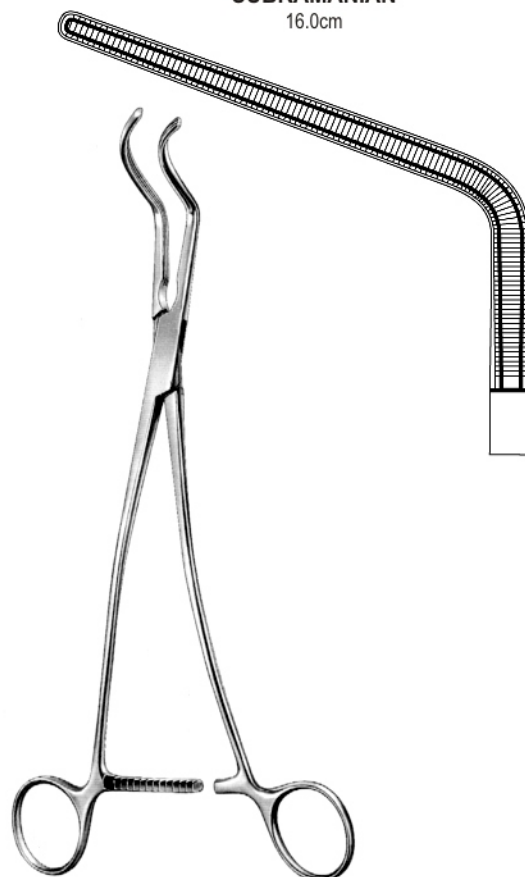

DE BAKEY

34.0314.27 27.0cm

34.0314.27

34-020

www.hilbro.net

Aortic Clamps EN

Aortaklemmen DE

Pinzas-clamps para aorta ES

34

ALSO AVAILABLE IN TITANIUM

CARDIOVASCULAR

Hilbro

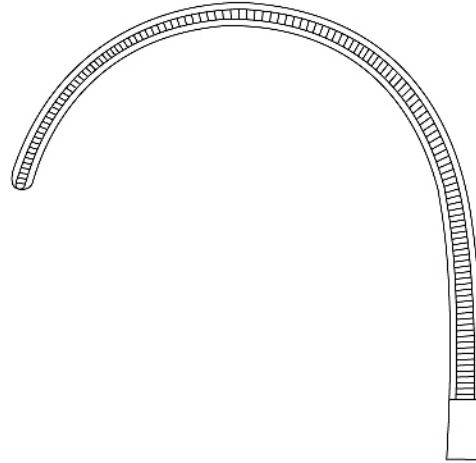
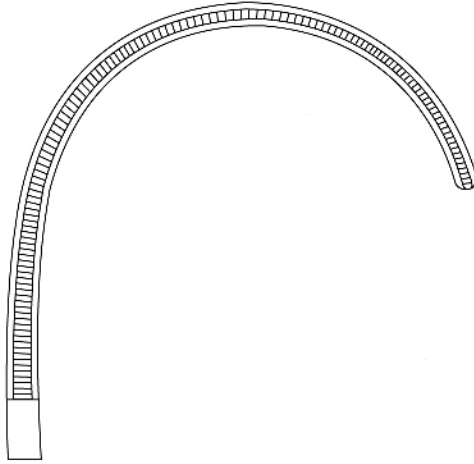

WEBER
34.0320.01 26.0cm



WEBER
34.0320.02 26.0cm

34.0320.02

34-021

www.hilbro.net

34

EN Aortic Clamps

DE Aortaklemmen

ES Piznas-clamps para aorta

Hilbro

CARDIOVASCULAR

ALSO AVAILABLE IN TITANIUM



34.0324.18
18.0cm

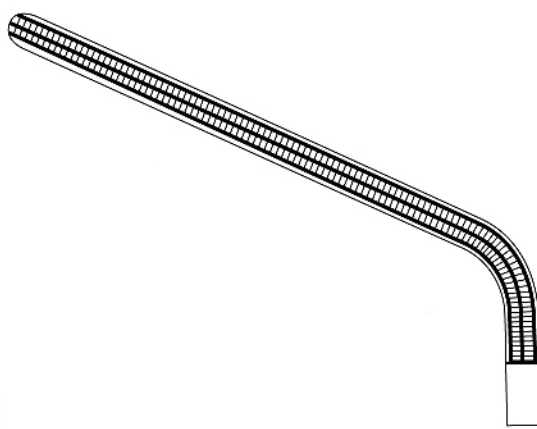

34.0324.20
20.0cm



MORRIS - DE BAKEY

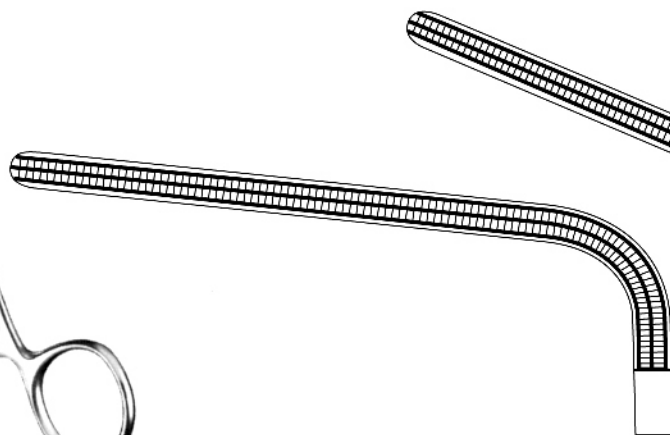

34.0324.23
23.0cm

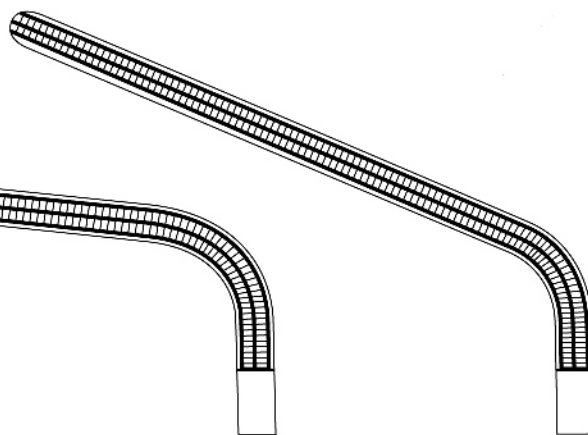

34.0324.25
25.0cm

34.0324.25

34-022

www.hilbro.net

Tangential Occlusion Clamps EN

Tangentialklemmen DE

Pinzas-clamps para oclusion tangencial ES

34

ALSO AVAILABLE IN TITANIUM

CARDIOVASCULAR



DE BAKEY SATINSKY



SATINSKY

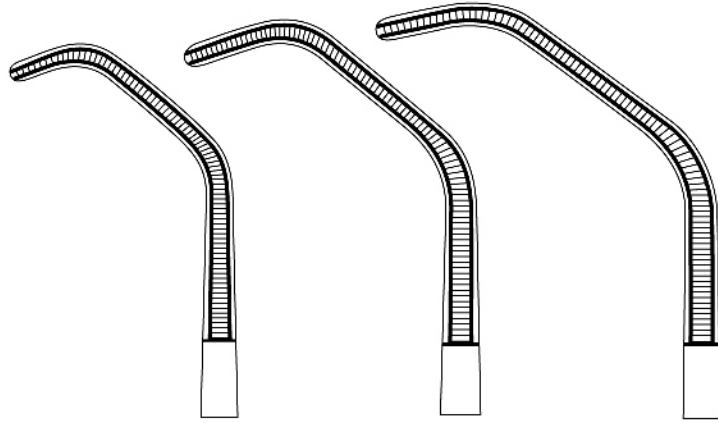

Fig.1

34.0330.23 23.5cm

Fig.2

34.0330.24 24.0cm

Fig.3

34.0330.25 25.0cm

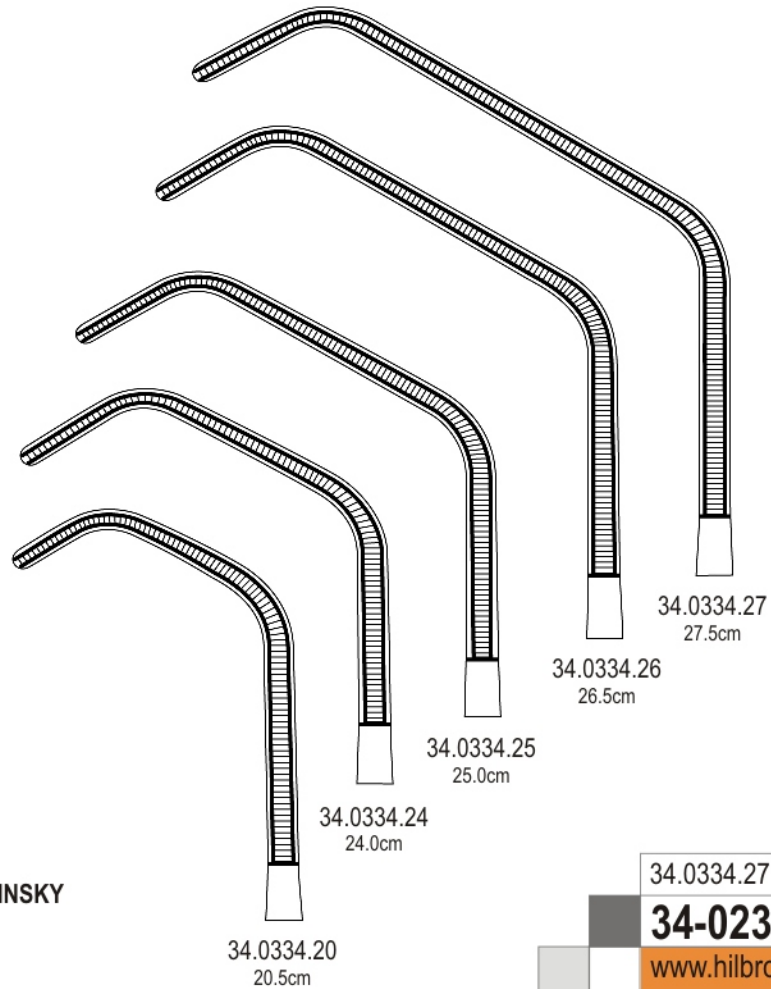

34.0334.27 27.5cm

34.0334.26 26.5cm

34.0334.25 25.0cm

34.0334.24 24.0cm

34.0334.20 20.5cm

34.0334.27

34-023

www.hilbro.net

EN Coarctation forceps, Renal Artery Clamp

DE Coarctationsklemmen, Nieren-Arterienklemme

ES Pinzas-clamps para coarctacion, pinzas-clamps para arteria renal



CARDIOVASCULAR

ALSO AVAILABLE IN TITANIUM

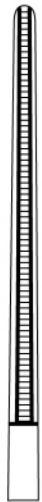

34.0340.22
22.0cm

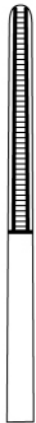

34.0340.21
21.0cm

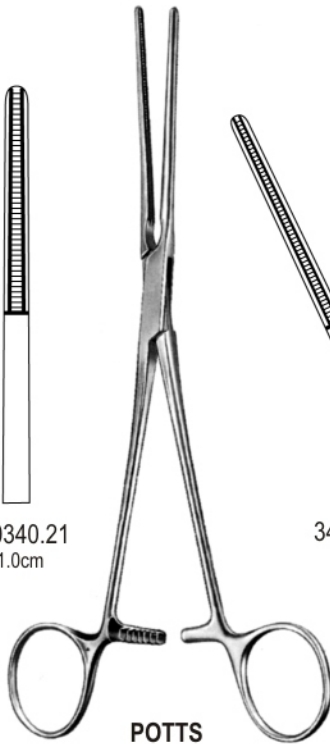

POTTS

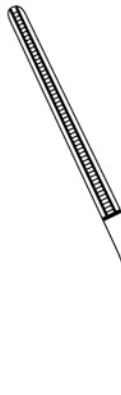

34.0341.21
21.0cm

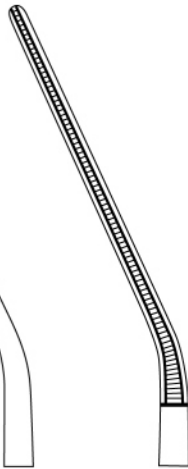

34.0341.22
22.0cm

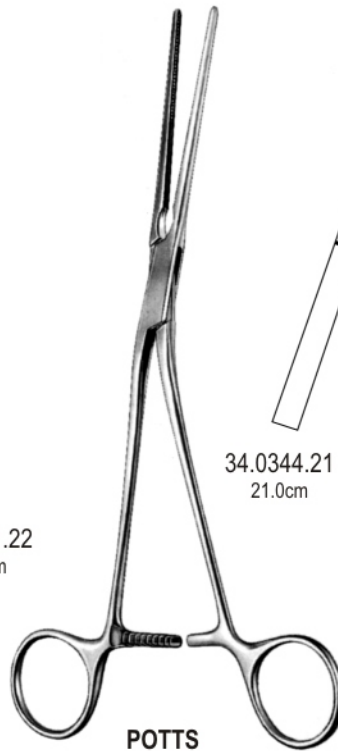

POTTS



34.0344.21
21.0cm

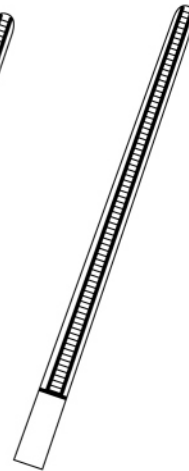

34.0344.22
22.0cm



34.0350.18
18.0cm

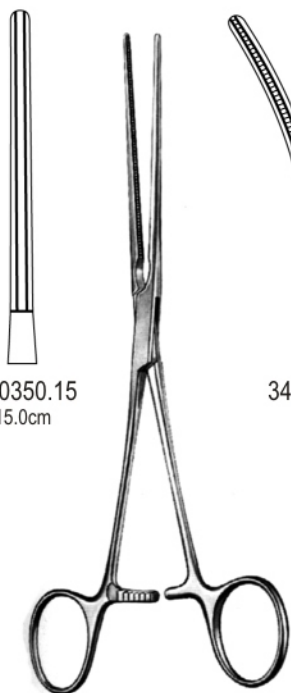

BAINBRIDGE



34.0350.15
15.0cm

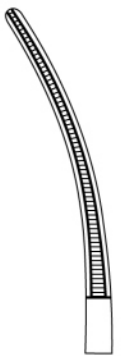

34.0351.15
15.0cm

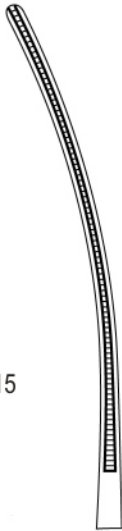

34.0351.18
18.0cm

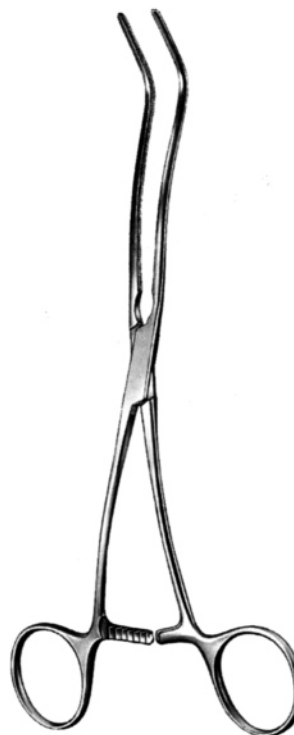

DE BAKAY

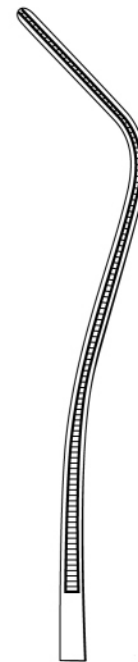

34.0354.20
20.0cm

34.0354.20

34-024

www.hilbro.net

Profunda Clamps, Peripheral Vascular Clamps EN

Profundaklemmen, Peripheral-Gefaßklemmen DE

Pinzas-clamps para la profunda, pinzas-clamps para vasos perifericos ES

34

ALSO AVAILABLE IN TITANIUM

CARDIOVASCULAR

Hilbro



GREGORY

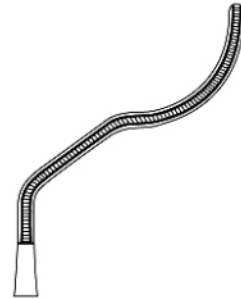

34.0360.14
14.0cm

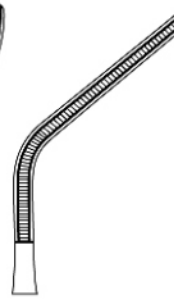

34.0360.16
16.0cm

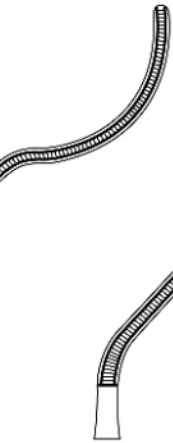

34.0360.18
18.0cm

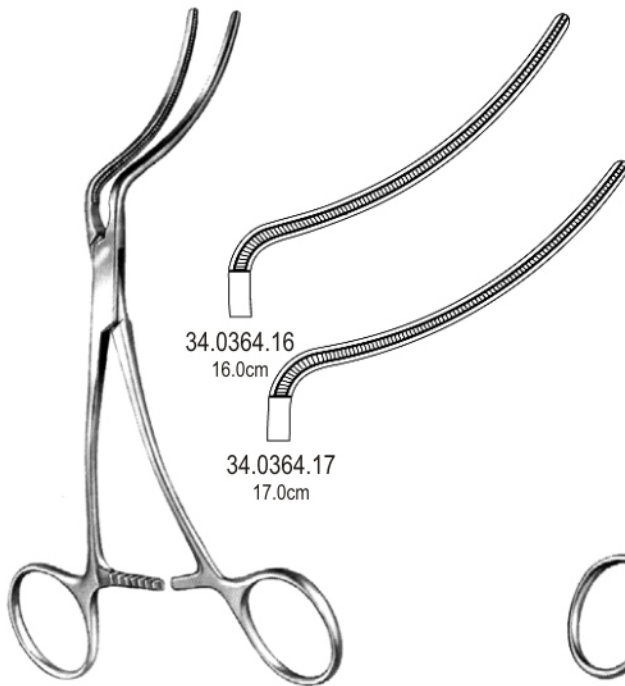

34.0364.16
16.0cm

34.0364.17
17.0cm

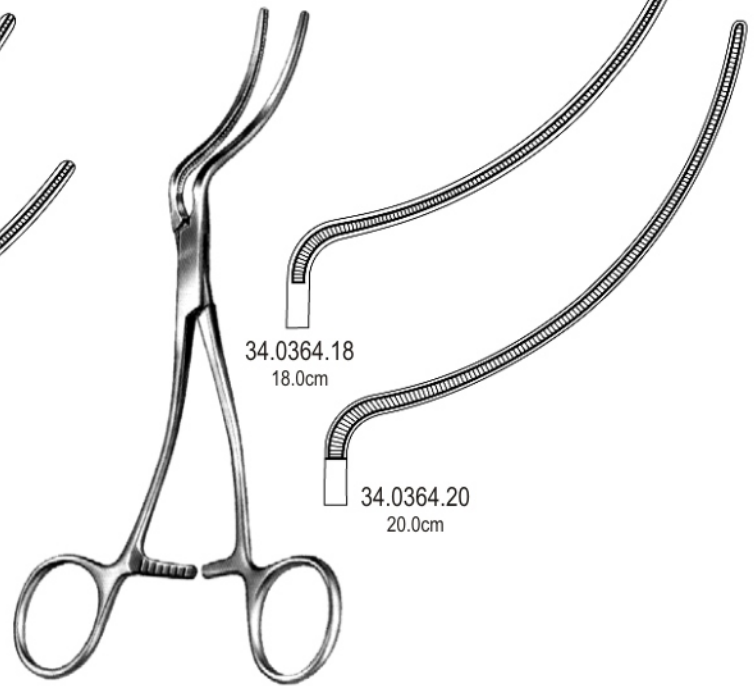

34.0364.18
18.0cm

34.0364.20
20.0cm

34.0364.20

34-025

www.hilbro.net

CARDIOVASCULAR

ALSO AVAILABLE IN TITANIUM

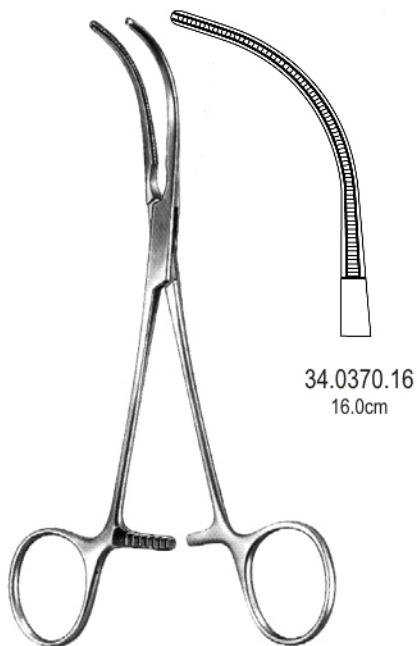

34.0370.16
16.0cm

DE BAKEY

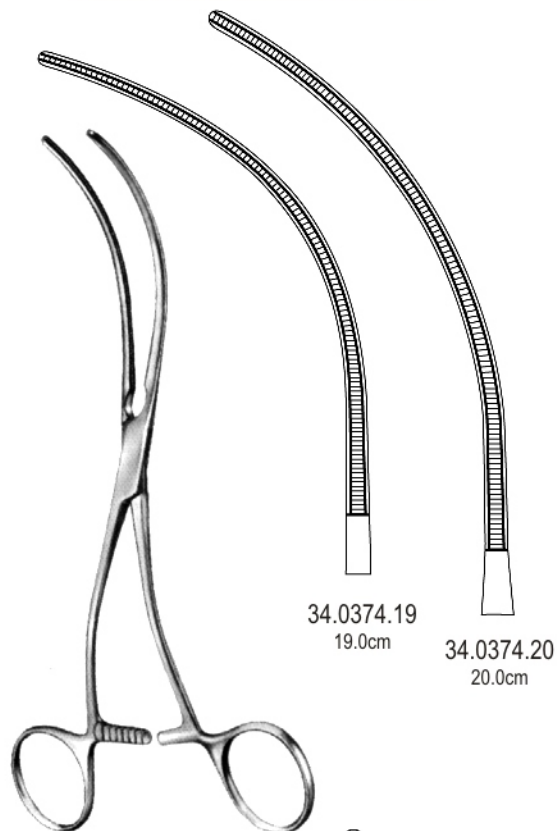

34.0374.19
19.0cm

34.0374.20
20.0cm

DE BAKEY

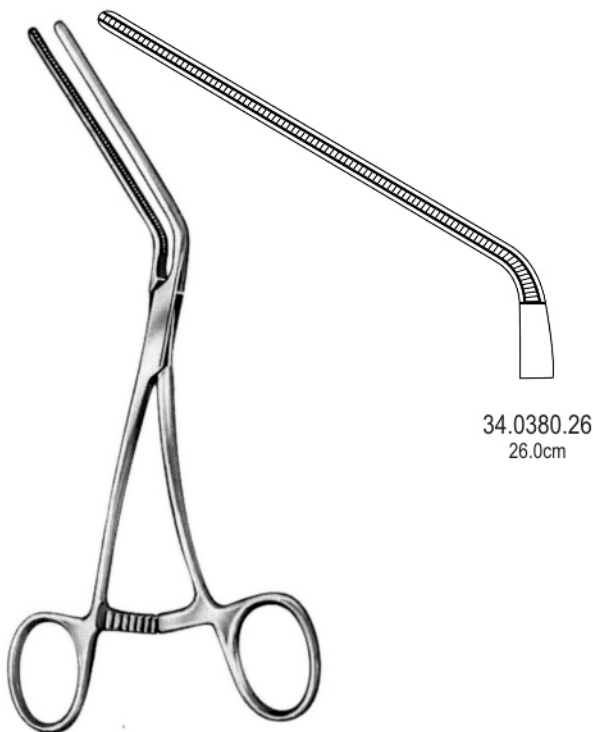

34.0380.26
26.0cm

DE BAKEY

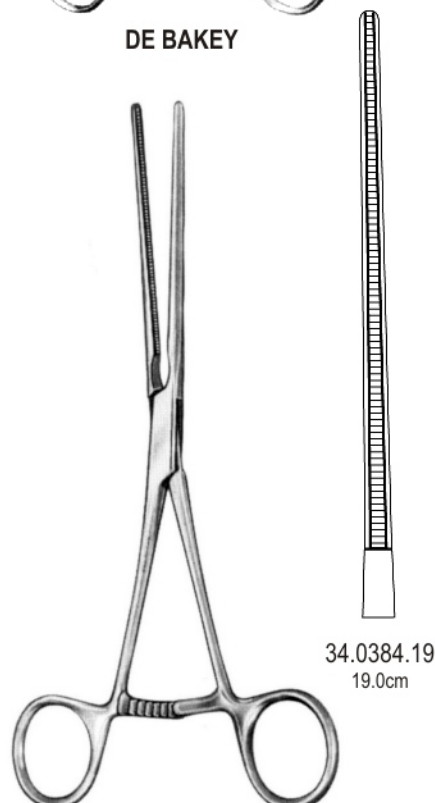

34.0384.19
19.0cm

LELAND JONES

34.0384.19

34-026

www.hilbro.net

ALSO AVAILABLE IN TITANIUM

CARDIOVASCULAR



LELAND JONES

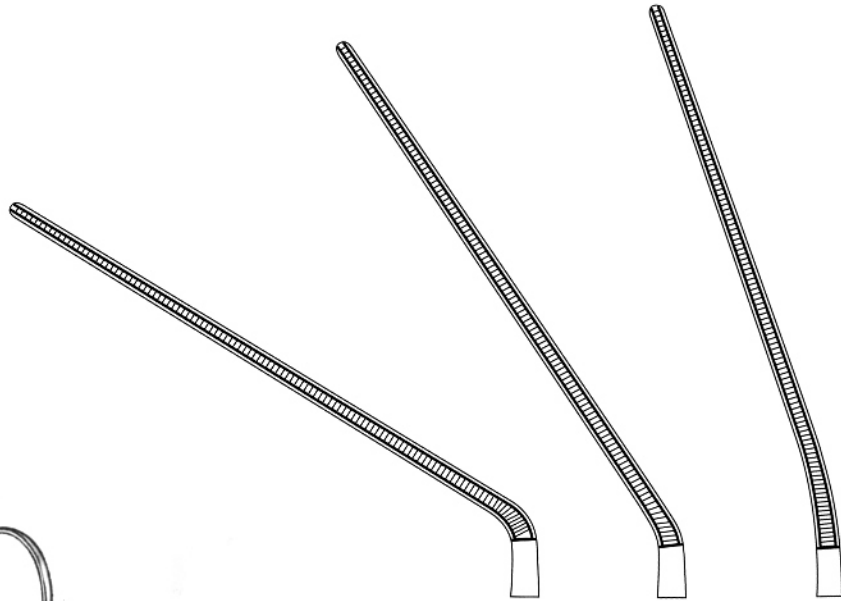

34.0390.18 18.0cm
 34.0390.19 19.0cm
 34.0390.20 20.0cm

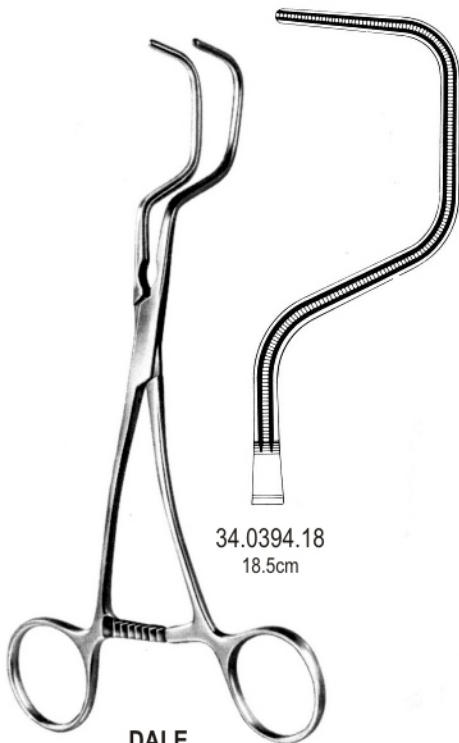

34.0394.18
 18.5cm

DALE



DALE



34.0400.17 17.0cm
 34.0400.18 18.0cm
 34.0400.19 19.0cm

34.0400.19

34-027

www.hilbro.net

EN Ligature Clamps

DE Ligaturklemmen

ES Pinzas para ligadura

Hilbro

CARDIOVASCULAR

ALSO AVAILABLE IN TITANIUM



DE BAKEY



34.0404.19
19.0cm

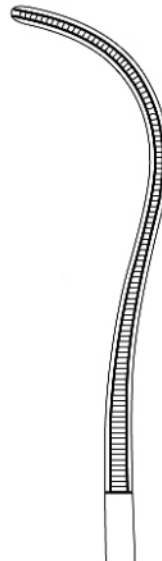

34.0404.23
23.0cm



DE BAKEY

34.0410.24
24.0cm

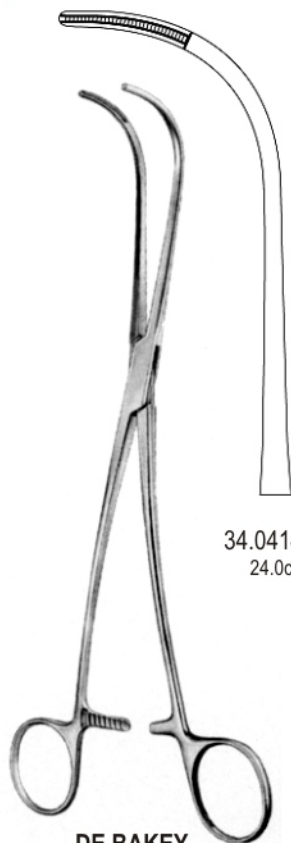

DE BAKEY

34.0414.24
24.0cm

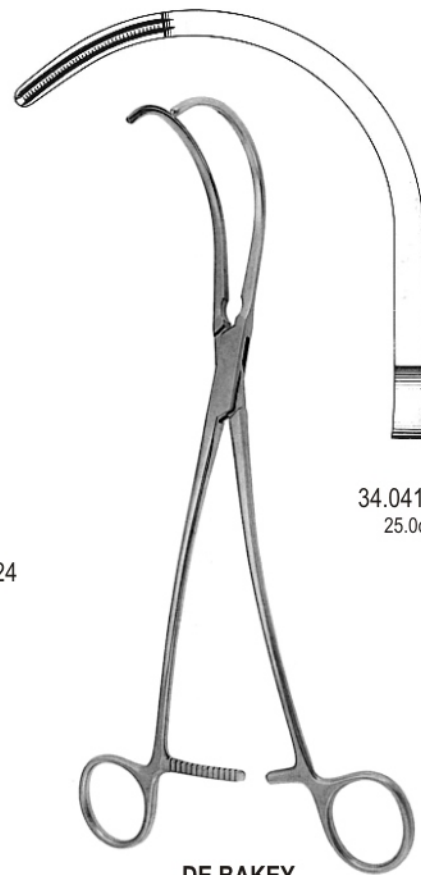

DE BAKEY

34.0414.25
25.0cm

34.0414.25

34-028

www.hilbro.net

ALSO AVAILABLE IN TITANIUM

CARDIOVASCULAR



HARKEN
24.0cm

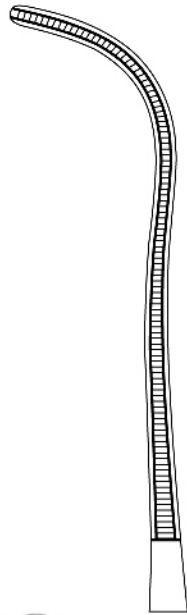

34.0420.01

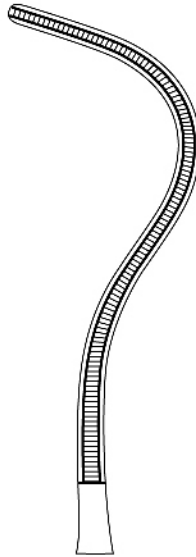

34.0420.02

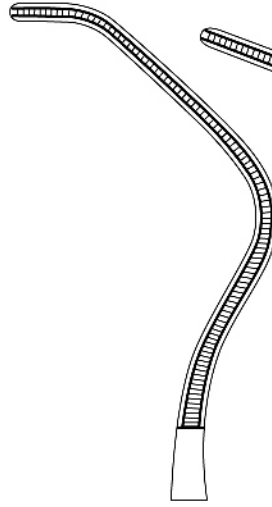

34.0420.03

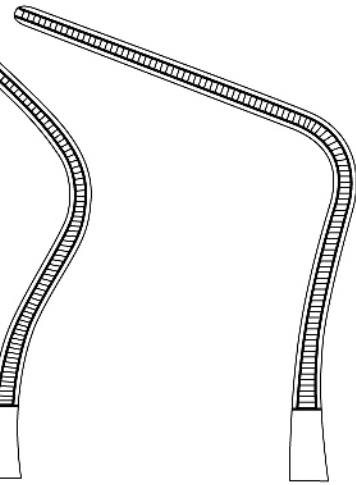

34.0420.04



LEES

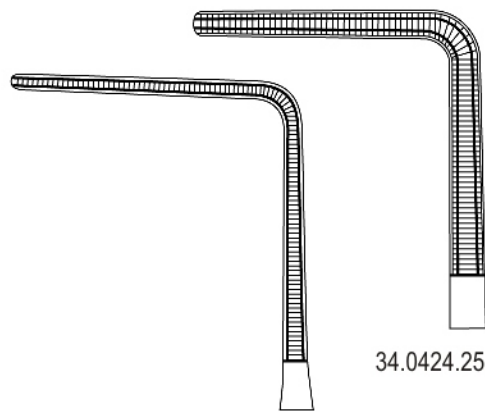

34.0424.23 23.0cm

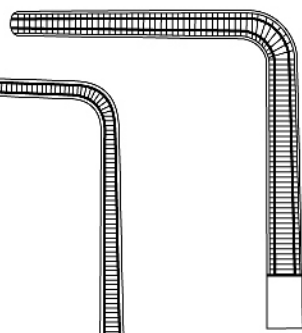

34.0424.25 25.0cm



LEES

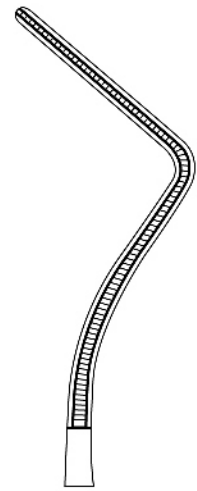

34.0430.25 25.0cm

34.0430.25

34-029

www.hilbro.net

- EN Coarctation Clamps
- DE Coarctationsklemmen
- ES Pinzas clamps para coarctacion



CARDIOVASCULAR

ALSO AVAILABLE IN TITANIUM



34.0434.21
21.0cm



34.0434.23
23.0cm



34.0434.27
27.0cm



34.0434.31
31.0cm

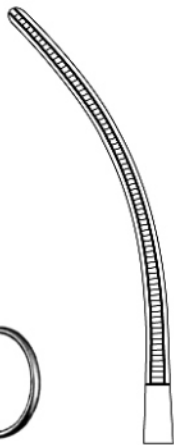

34.0435.21
21.0cm



34.0435.23
23.0cm

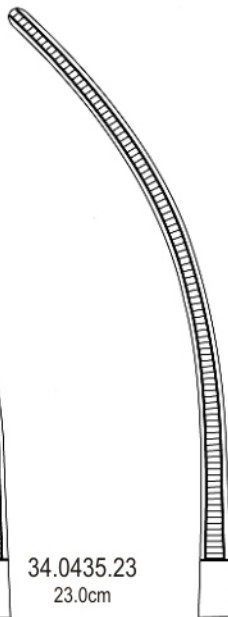

34.0435.27
27.0cm

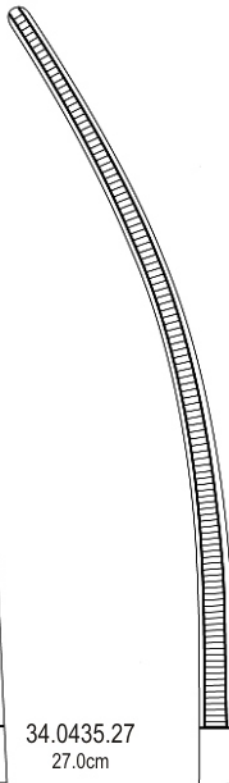

34.0435.31
31.0cm

34.0435.31

34-030

www.hilbro.net

ALSO AVAILABLE IN TITANIUM

CARDIOVASCULAR

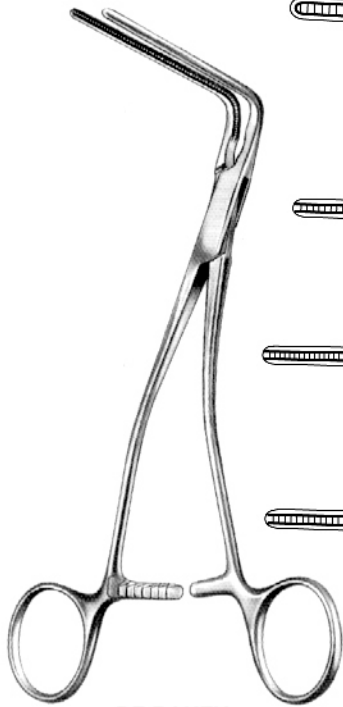

DE BAKEY

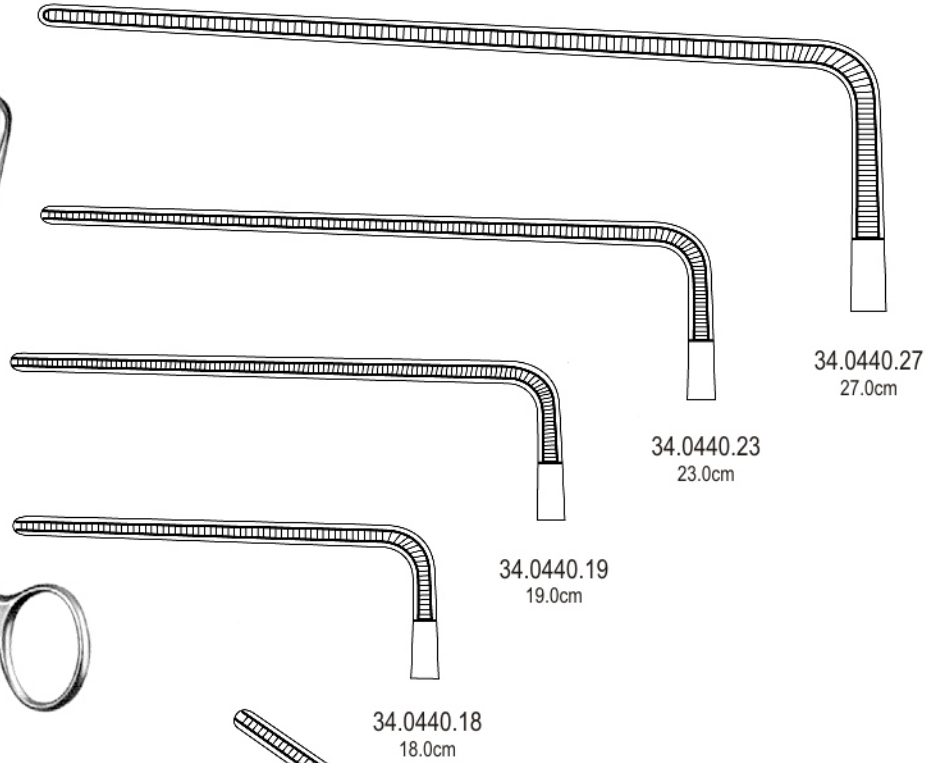

DE BAKEY

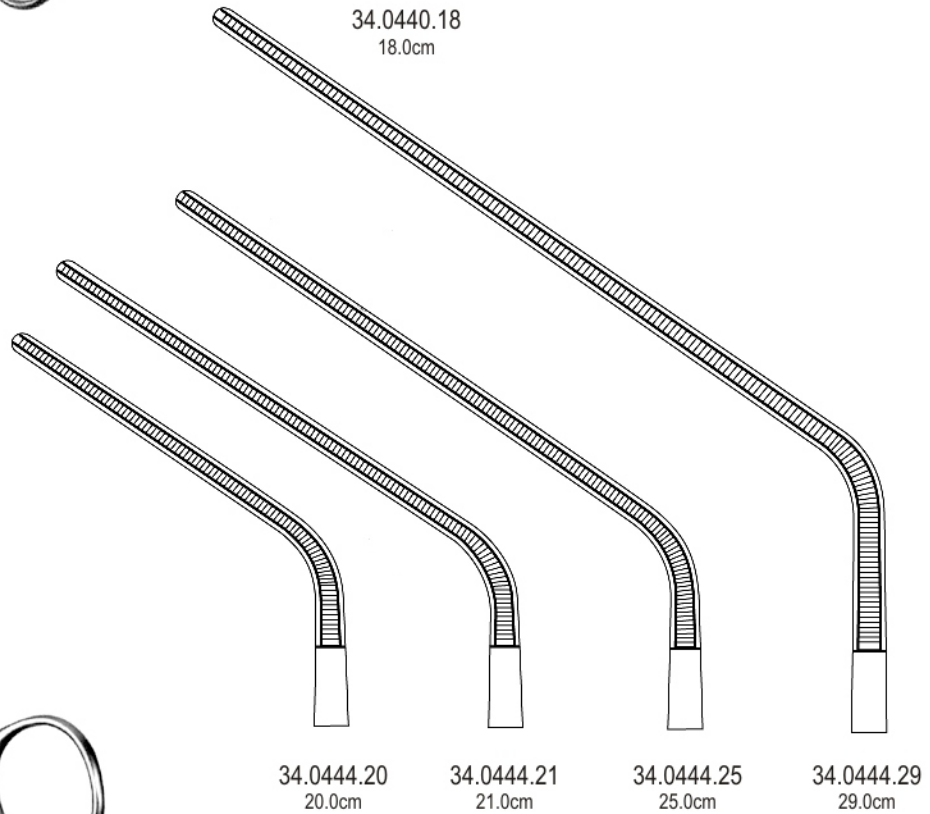

34.0444.29

34-031

www.hilbro.net

EN Atrauma Cardiovascular Forceps

DE Atrauma Cardiovascular-Klemmen

ES Atrauma pinzas-clamps cardiovasculares



CARDIOVASCULAR

ALSO AVAILABLE IN TITANIUM

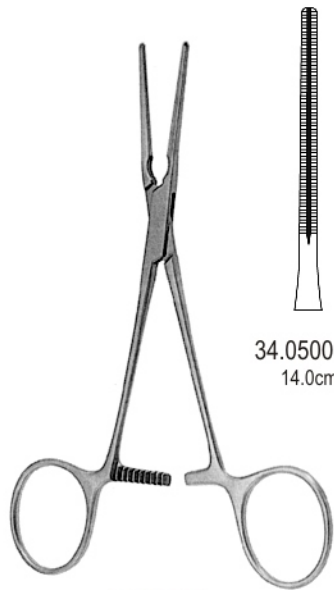

34.0500.01
14.0cm

COOLEY

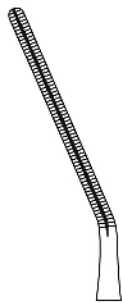

34.0500.02
14.0cm

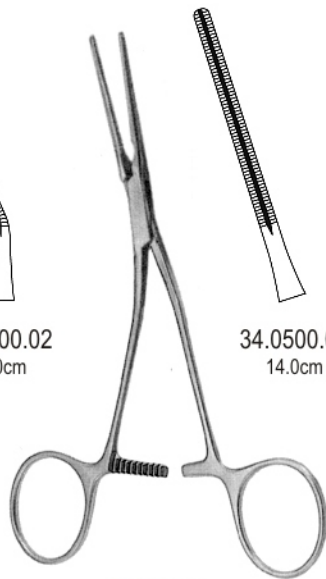

34.0500.03
14.0cm

COOLEY

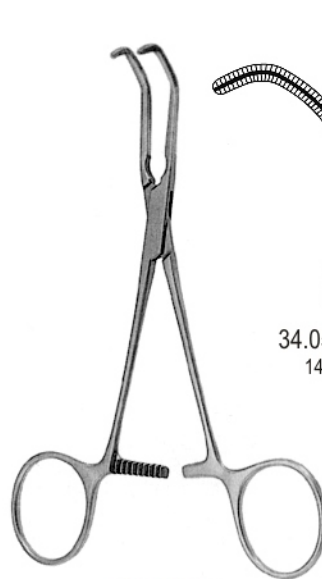

34.0500.04
14.0cm

COOLEY



34.0500.05
14.0cm

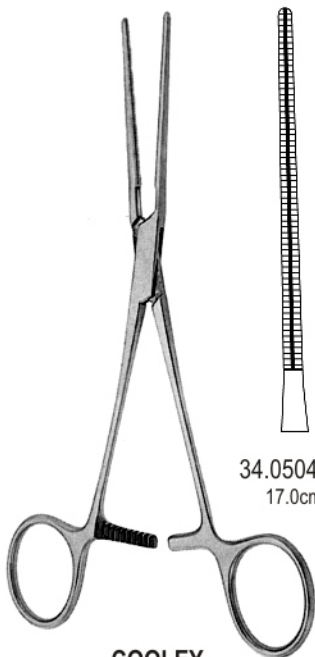

34.0504.17
17.0cm

COOLEY

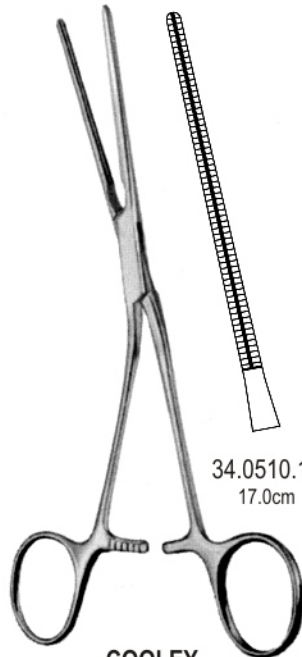

34.0510.17
17.0cm

COOLEY

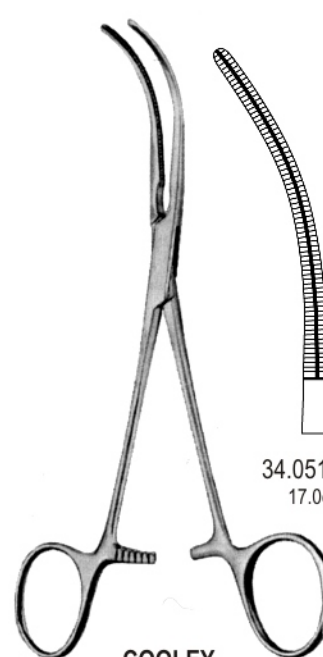

34.0514.17
17.0cm

COOLEY

34.0514.17

34-032

www.hilbro.net

ALSO AVAILABLE IN TITANIUM

CARDIOVASCULAR

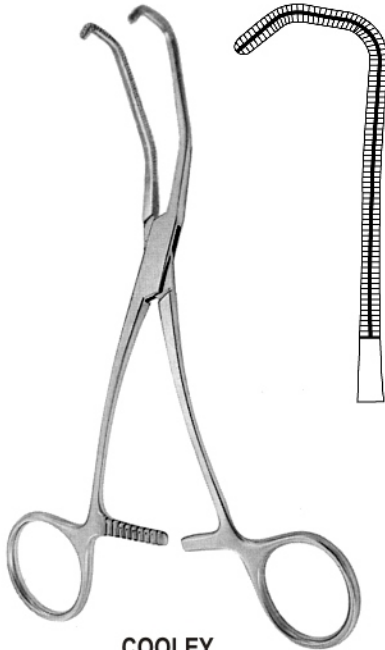

COOLEY
34.0520.17 17.0cm

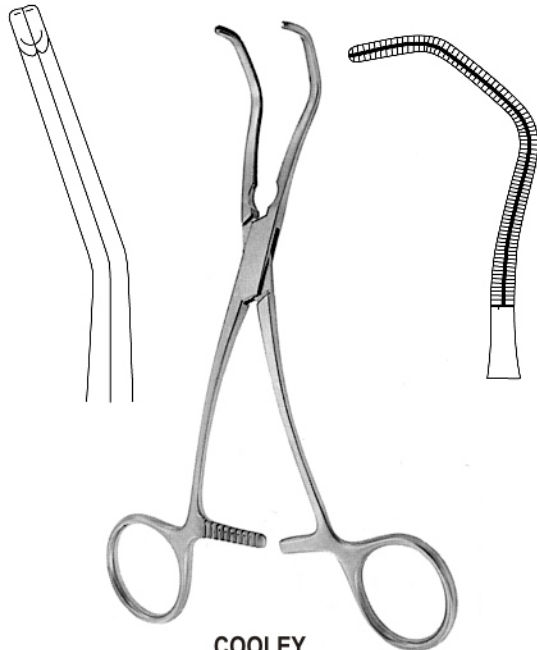

COOLEY
34.0524.16 16.0cm



COOLEY
34.0530.14 14.0cm

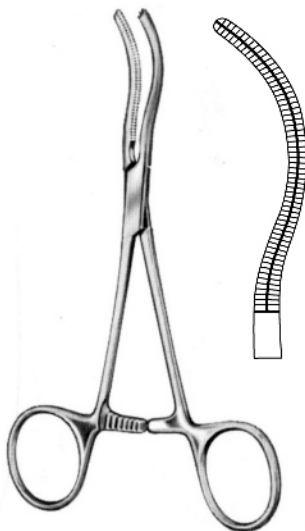

COOLEY
34.0534.14 14.0cm

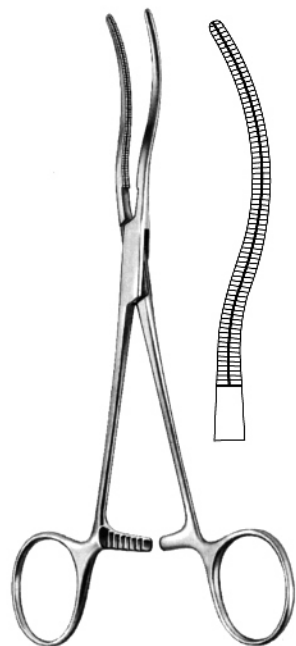

COOLEY
34.0540.17 17.0cm

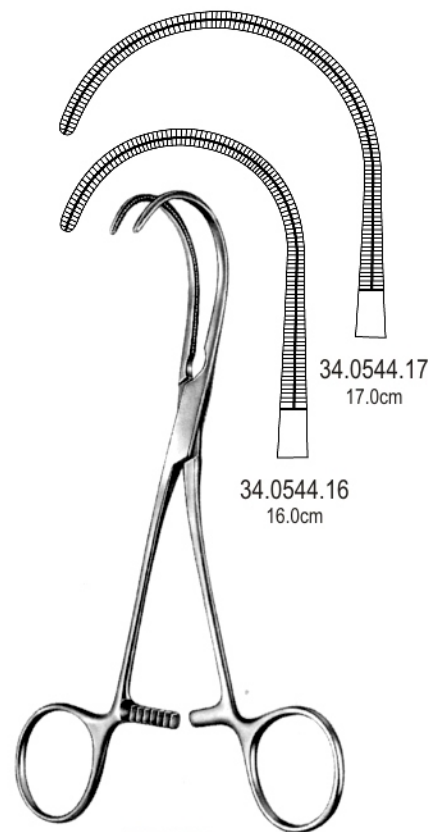

34.0544.16
16.0cm

34.0544.17
17.0cm

COOLEY

34.0544.17

34-033

www.hilbro.net

34

EN Atrauma Cardiovascular Forceps

DE Atrauma Cardiovascular-Klemmen

ES Atrauma pinzas-clamps cardiovasculares

Hilbro

CARDIOVASCULAR

ALSO AVAILABLE IN TITANIUM



COOLEY-DERRA

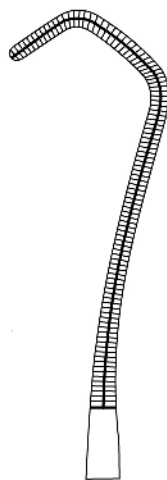

34.0550.16
16.0cm

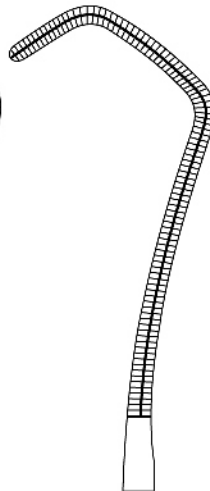

34.0550.17
17.0cm

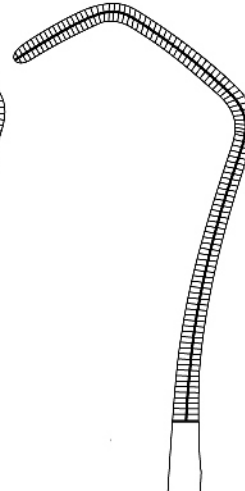

34.0550.18
18.0cm



COOLEY

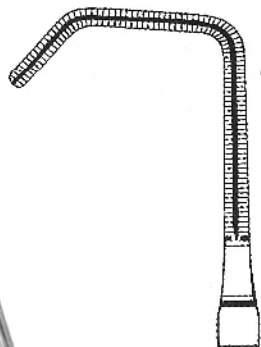

34.0560.01
16.5cm

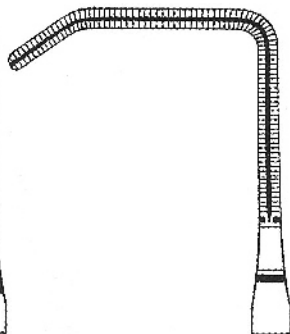

34.0560.02
16.5cm

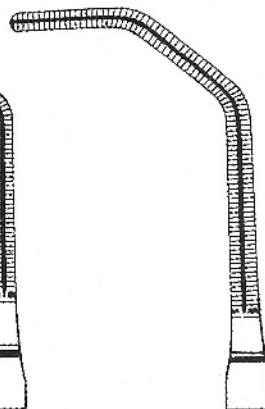

34.0560.03
17.5cm

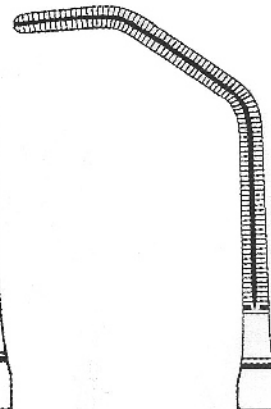

34.0560.04
17.5cm

34.0560.03

34-034

www.hilbro.net

Atrauma Forceps EN

Atrauma Klemmen DE

Atrauma pinzas-clamps ES

34

ALSO AVAILABLE IN TITANIUM

CARDIOVASCULAR

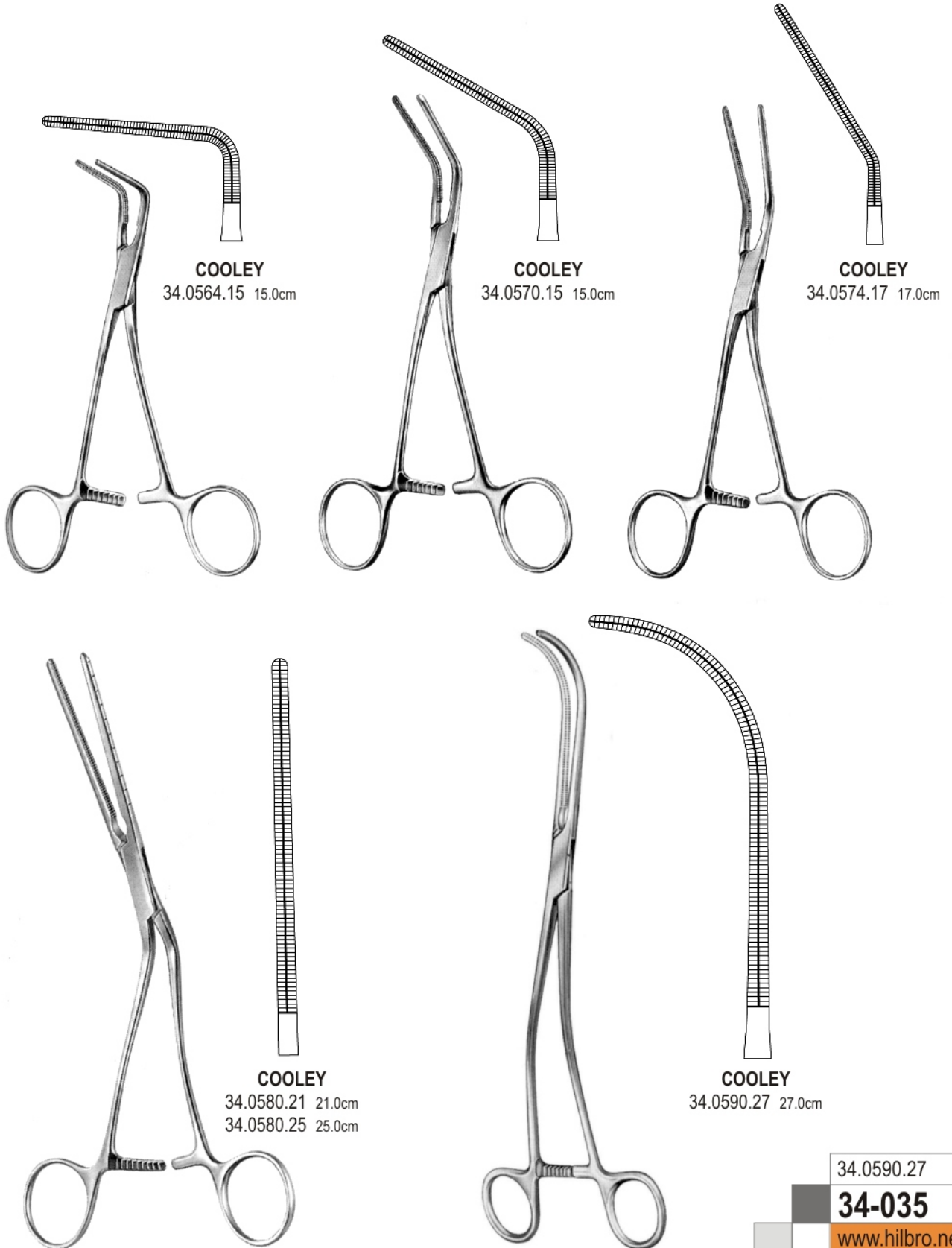

COOLEY

34.0564.15 15.0cm

COOLEY

34.0570.15 15.0cm

COOLEY

34.0574.17 17.0cm

COOLEY

34.0580.21 21.0cm
34.0580.25 25.0cm

COOLEY

34.0590.27 27.0cm

34.0590.27

34-035

www.hilbro.net

EN Atrauma Forceps

DE Atrauma Klemmen

ES Atrauma pinzas-clamps

Hilbro

CARDIOVASCULAR

ALSO AVAILABLE IN TITANIUM



COOLEY
34.0594.17 17.0cm

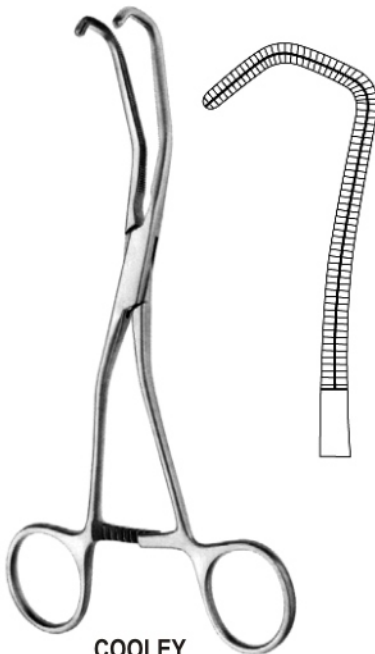

COOLEY
34.0596.17 17.0cm

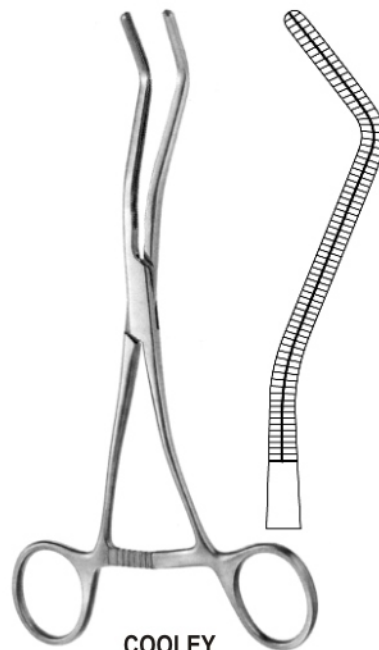

COOLEY
34.0600.18 18.0cm

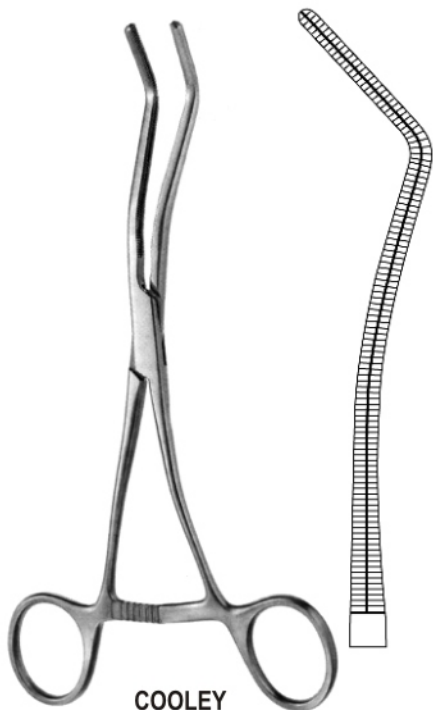

COOLEY
34.0602.19 19.0cm

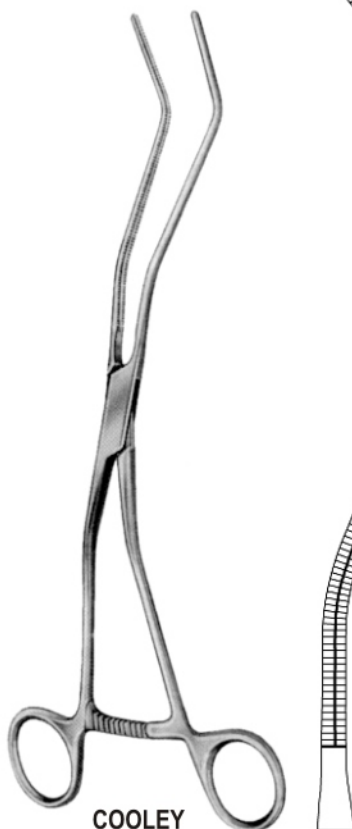

COOLEY
34.0604.26 26.0cm

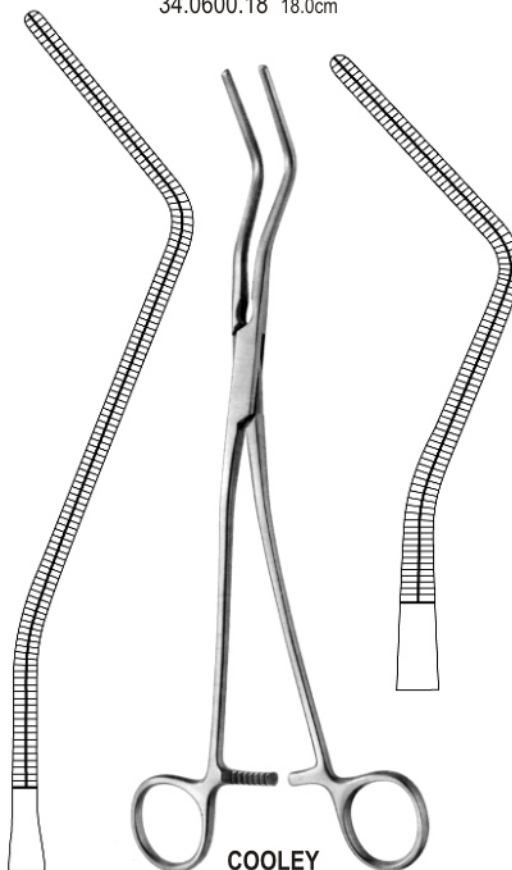

COOLEY
34.0606.27 27.0cm

34.0606.27

34-036

www.hilbro.net

ALSO AVAILABLE IN TITANIUM

CARDIOVASCULAR



34.0610.15 15.0cm

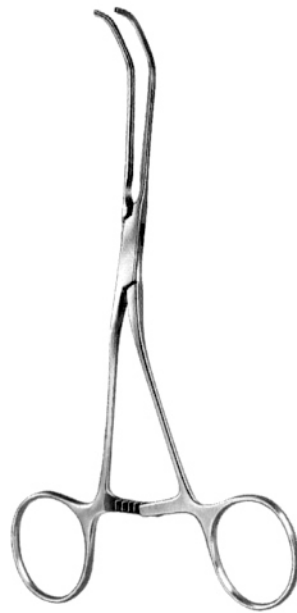
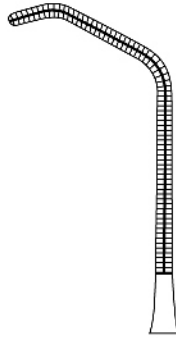

34.0614.15 15.5cm

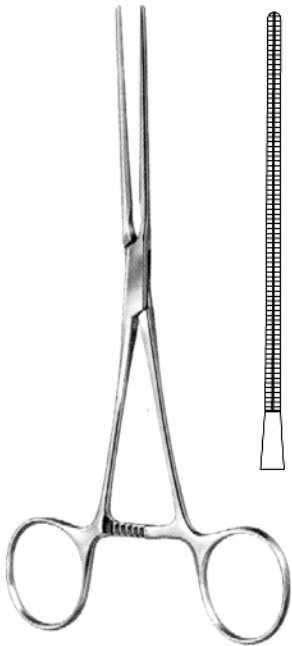
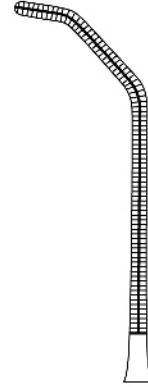

34.0620.16 16.5cm

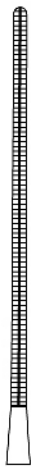

34.0622.16 16.0cm

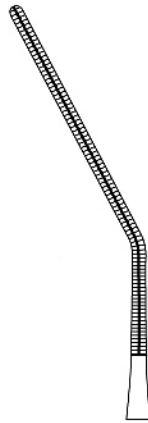

34.0624.15 15.0cm

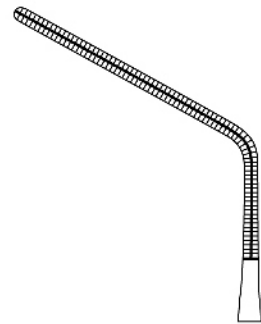

34.0624.15

34-037

www.hilbro.net

EN Neonatal and Pediatric Clamps, Delicate Pattern

DE Neonatal-und Kinderklemmen, Extrafeine Modelle

ES Pinzas clamps para recién nacidos y pediátricos muy delicados

Hilbro

CARDIOVASCULAR

ALSO AVAILABLE IN TITANIUM

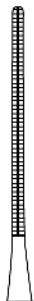

1

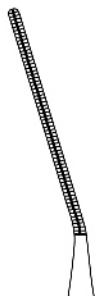

2

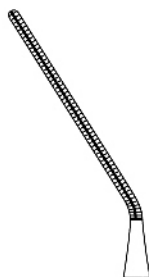

3

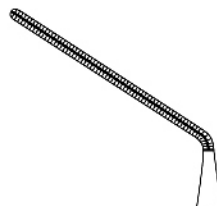

4

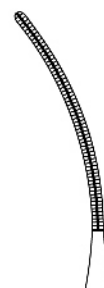

5



6

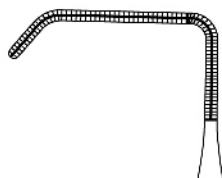

7

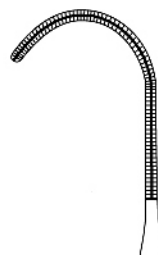

8

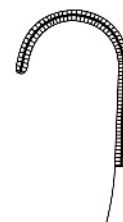

9

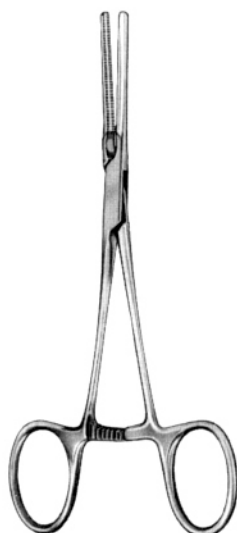

- 1 34.0630.01 14.5cm
- 2 34.0630.02 14.5cm
- 3 34.0630.03 14.5cm
- 4 34.0630.04 13.5cm
- 5 34.0630.05 14.0cm
- 6 34.0630.06 13.5cm
- 7 34.0630.07 13.5cm
- 8 34.0630.08 14.0cm
- 9 34.0630.09 13.5cm

- 1 34.0632.01 14.5cm
- 2 34.0632.02 14.5cm
- 3 34.0632.03 14.5cm
- 4 34.0632.04 13.5cm
- 5 34.0632.05 14.0cm
- 6 34.0632.06 13.5cm
- 7 34.0632.07 13.5cm
- 8 34.0632.08 14.0cm
- 9 34.0632.09 13.5cm

- 1 34.0634.01 14.5cm
- 2 34.0634.02 14.5cm
- 3 34.0634.03 14.5cm
- 4 34.0634.04 13.5cm
- 5 34.0634.05 14.0cm
- 6 34.0634.06 13.5cm
- 7 34.0634.07 13.5cm
- 8 34.0634.08 14.0cm
- 9 34.0634.09 13.5cm

34.0634.09

34-038

www.hilbro.net

ALSO AVAILABLE IN TITANIUM

CARDIOVASCULAR

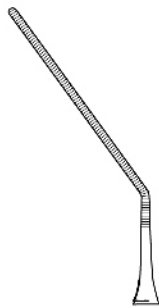

34.0640.01
13.0cm

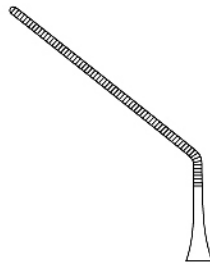

34.0640.02
13.0cm

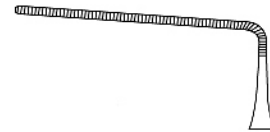

34.0640.03
11.0cm



CASTANEDA

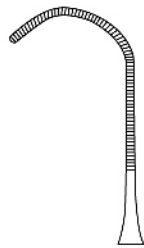

34.0642.01
12.0cm

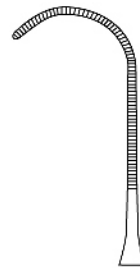

34.0642.02
12.0cm



34.0642.03
12.0cm

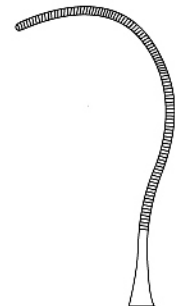

34.0642.04
12.0cm

34.0642.04

34-039

www.hilbro.net

CARDIOVASCULAR



JAVID
34.0650.18 18.0cm



JAVID
34.0650.19 19.0cm

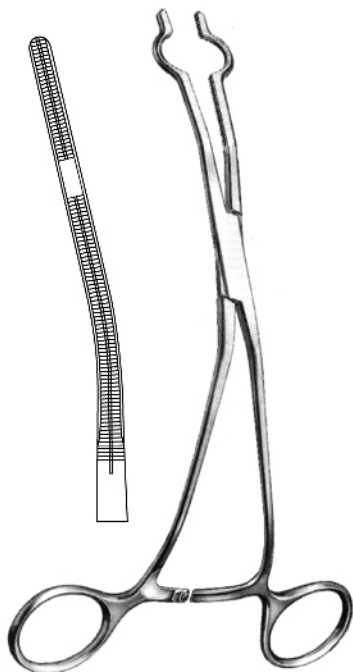

COOLEY

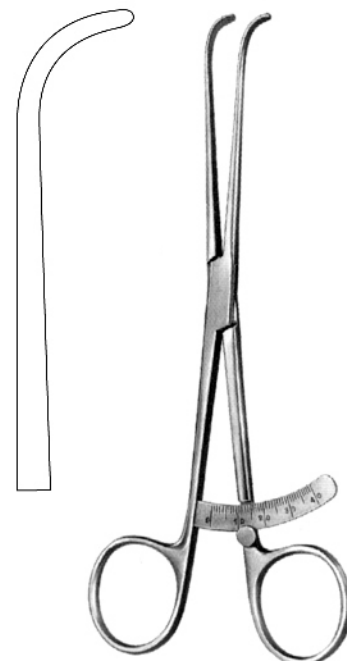
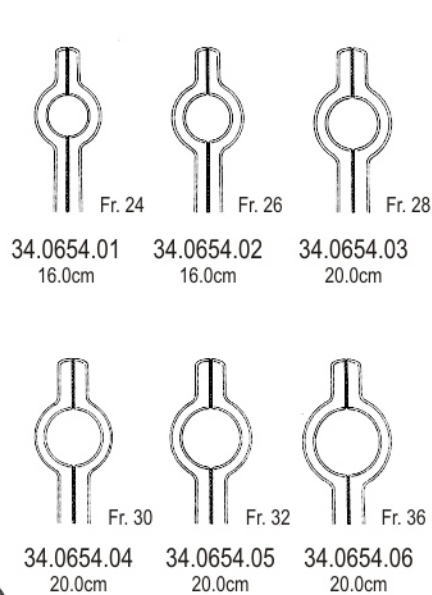

34.0660.18 18.0cm

34.0660.18

34-040

www.hilbro.net

Universal Clamps EN

Mehrzweckklemmen DE

Pinze universali ES

34

ALSO AVAILABLE IN TITANIUM

CARDIOVASCULAR

Hilbro

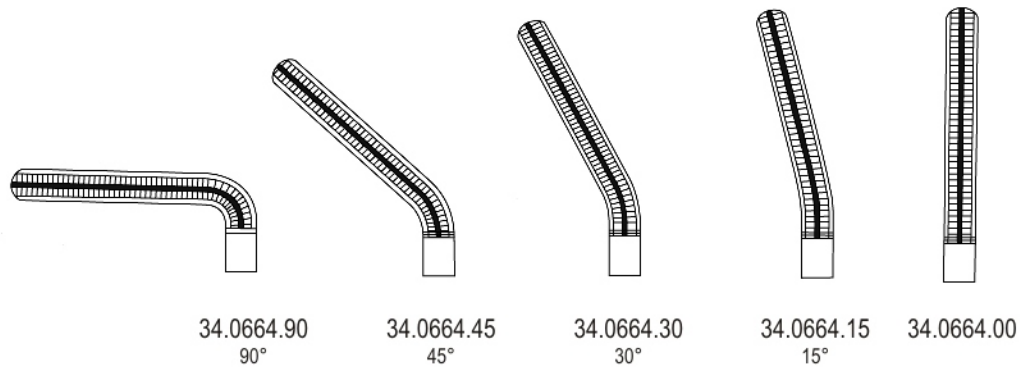

DARDIK

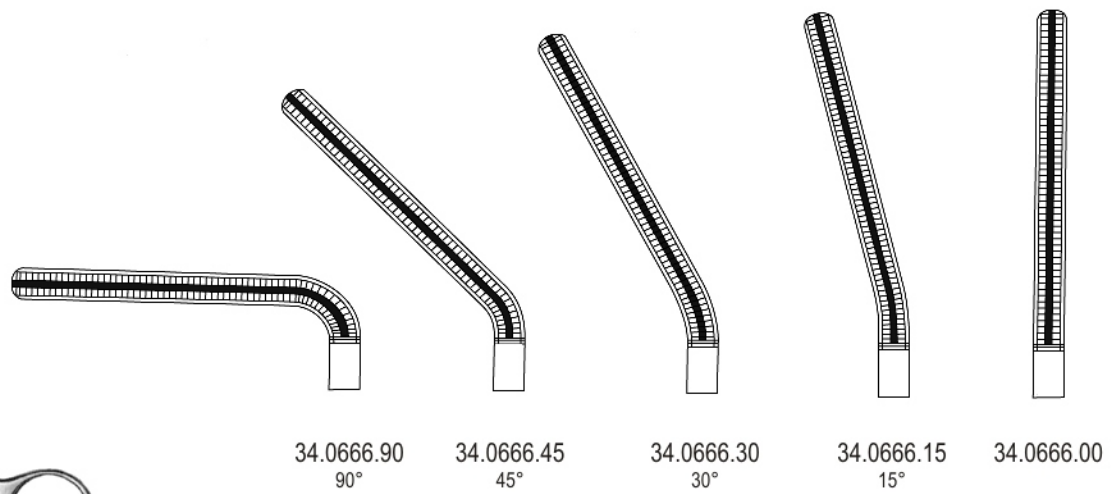

34.0666.00

34-041

www.hilbro.net

EN Blood Vessel Clamps

DE Clamps p/vasos

ES Gefäßklemmen



CARDIOVASCULAR



34.0680.15

BABY-SATINSKY
15.0cm

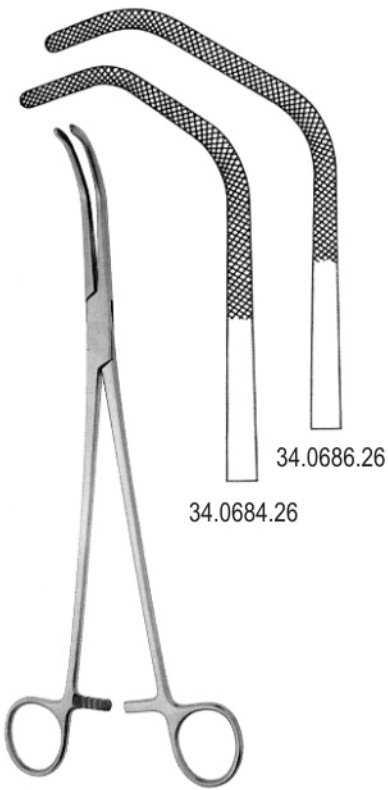

34.0684.26
34.0686.26

SATINSKY
26.5cm

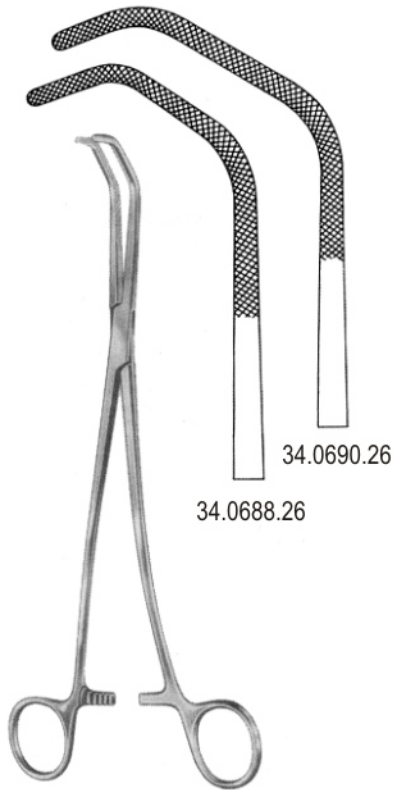

34.0688.26
34.0690.26

SATINSKY
26.5cm

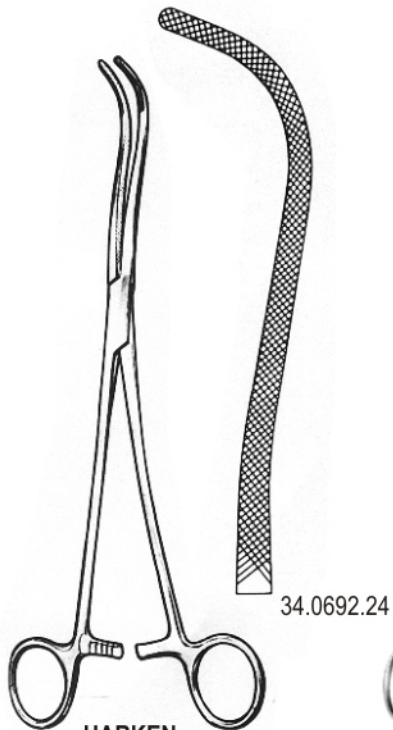

34.0692.24

HARKEN
24.0cm



HARKEN
24.0cm

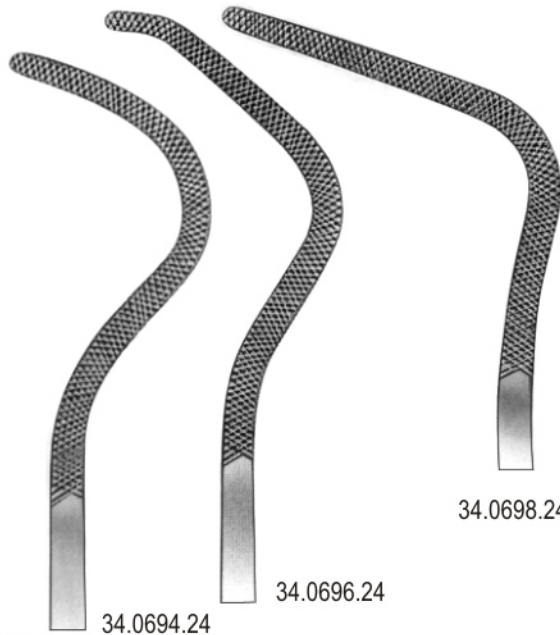

34.0694.24

34.0696.24

34.0698.24

34.0698.24

34-042

www.hilbro.net

Lung Grasping Forceps, Aorta Clamps EN

Pinzas-Clamps p/pulmón, Clamps aorta DE

Lungenfasszangen, Aortaklemmen ES

34

CARDIOVASCULAR



LOVELACE
34.0710.20 20.0cm

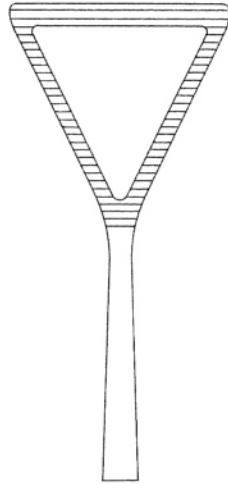

LOVELACE
34.0711.20 20.0cm

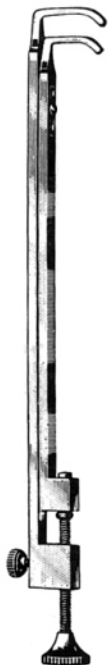

BLALOCK

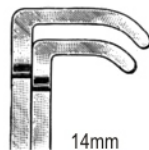

34.0720.14 15.0cm

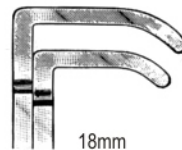

34.0722.18 20.0cm

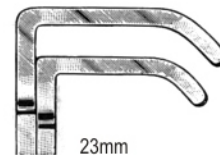

34.0722.23 20.0cm

34.0722.23

34-043

www.hilbro.net

CARDIOVASCULAR

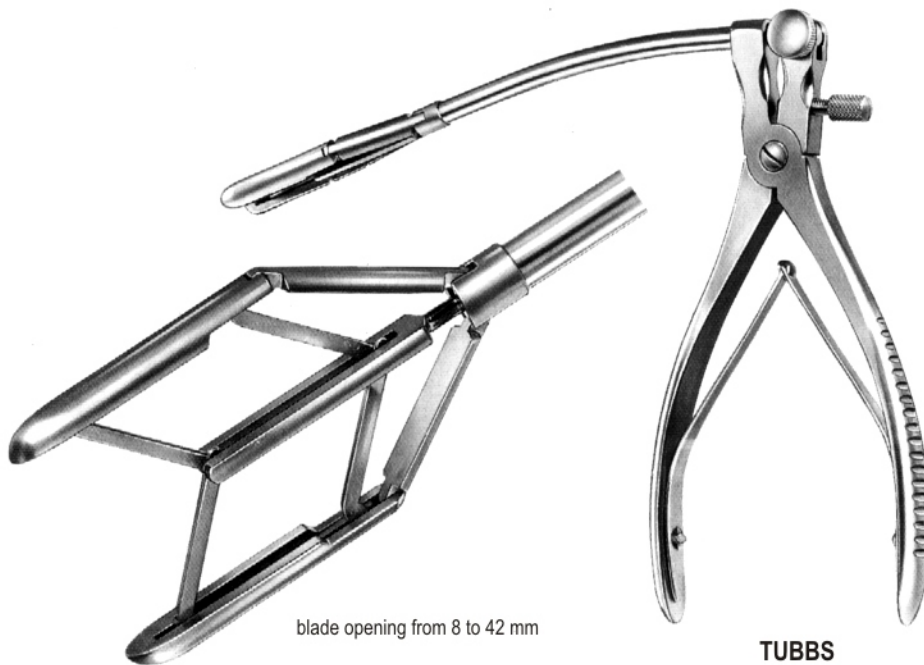

blade opening from 8 to 42 mm

TUBBS
34.0740.42

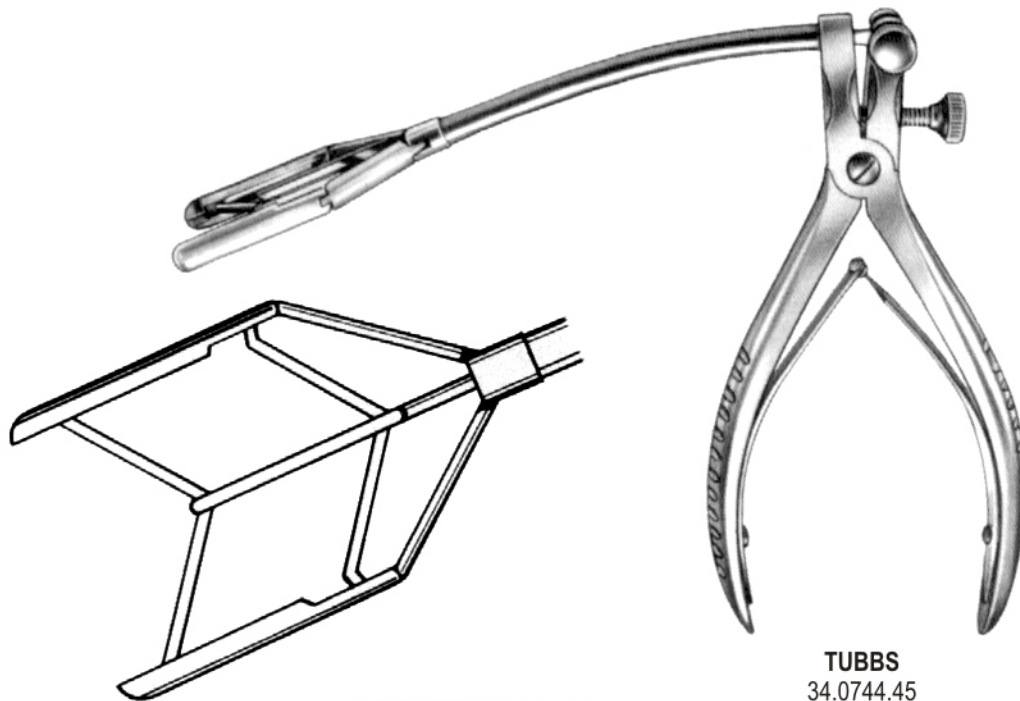

blade opening from 9 to 45 mm

TUBBS
34.0744.45

34.0744.45

34-044

www.hilbro.net

Vascular Dilators EN

Gefäß-Dilatoren DE

Dilatadores vasculares ES

34

CARDIOVASCULAR

Hilbro

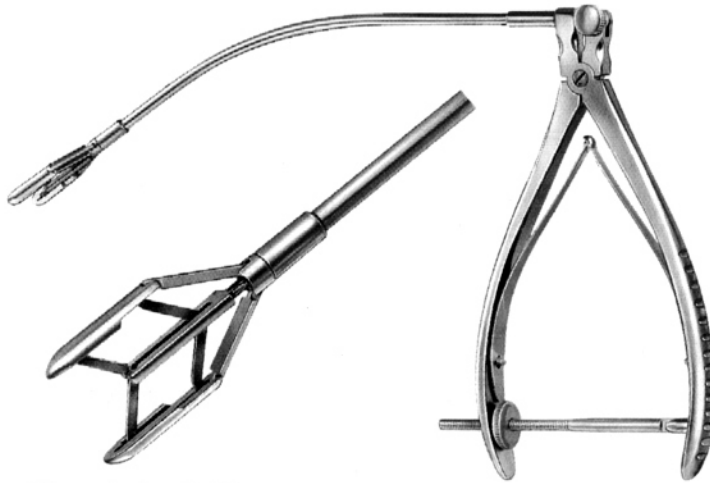

blade opening from 8 to 15 mm
blade opening from 8 to 45 mm

COOLEY
34.0750.15
34.0750.45

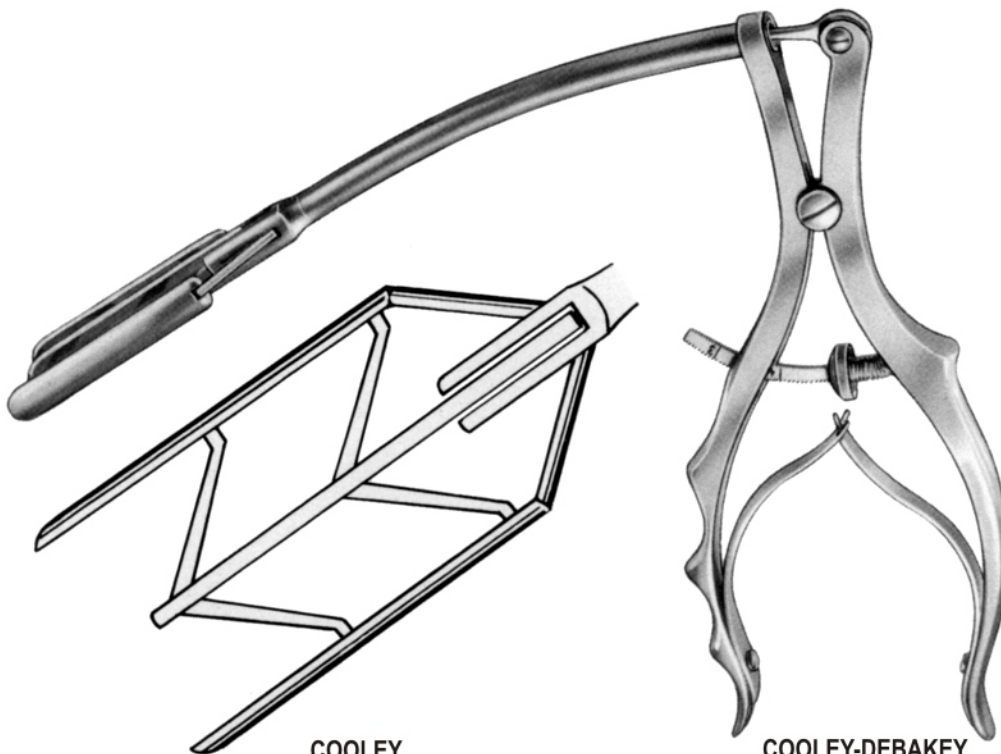

COOLEY
34.0754.40
blade opening 9 - 40mm

COOLEY-DEBAKEY
34.0756.30
blade opening 7 - 30mm

34.0756.30

34-045

www.hilbro.net

34

EN Vascular Dilators

DE Gefäß-Dilatoren

ES Dilatadores vasculares

Hilbro

CARDIOVASCULAR

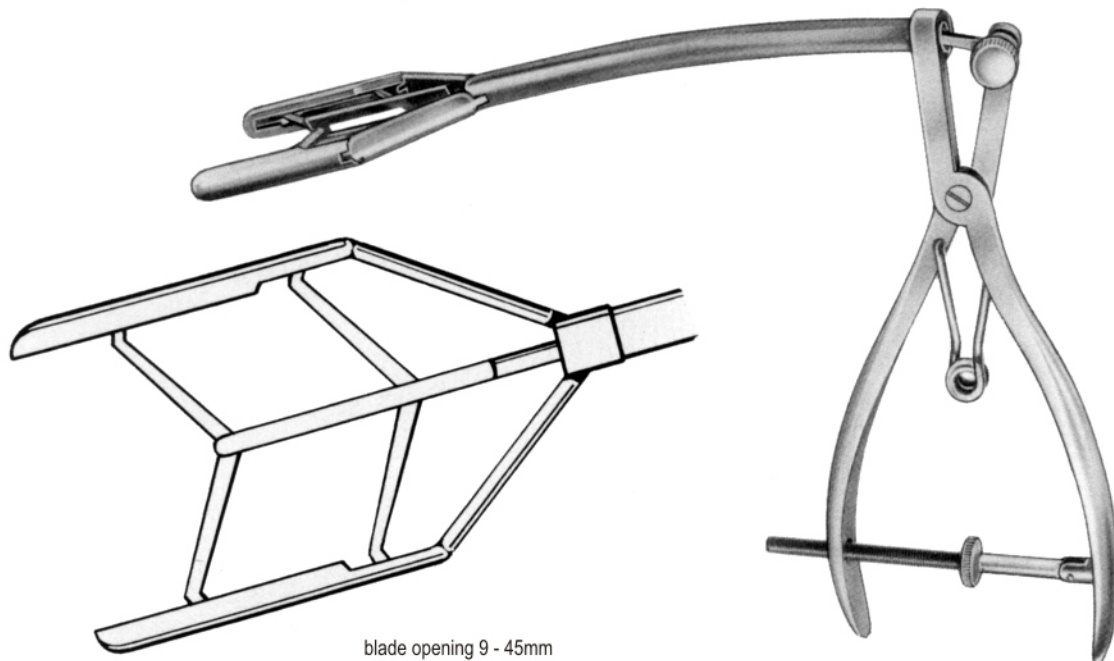

blade opening 9 - 45mm

GERBODE
34.0760.45

34.0760.45

34-046

www.hilbro.net

Mitral valve Dilators EN
Mitral ventil dilatoren DE
Dilatadores mitral de válvula ES

34

CARDIOVASCULAR

Hilbro

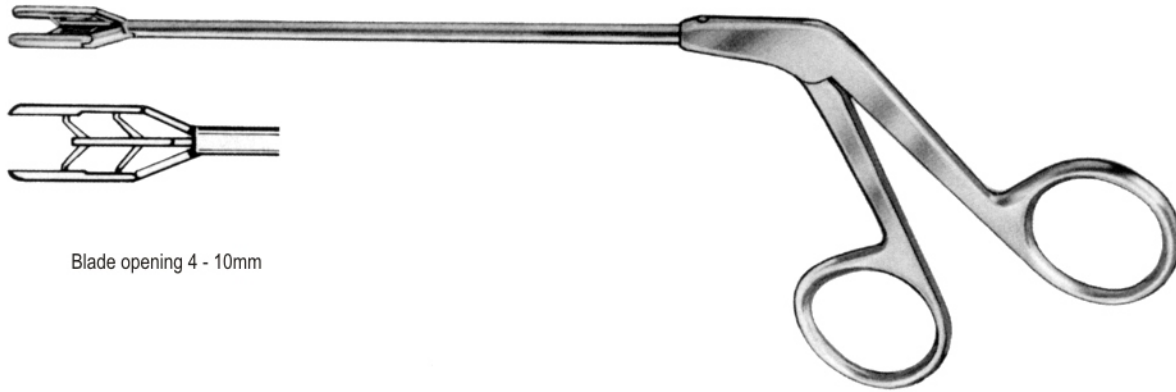

Blade opening 4 - 10mm

HETZER
34.0770.10

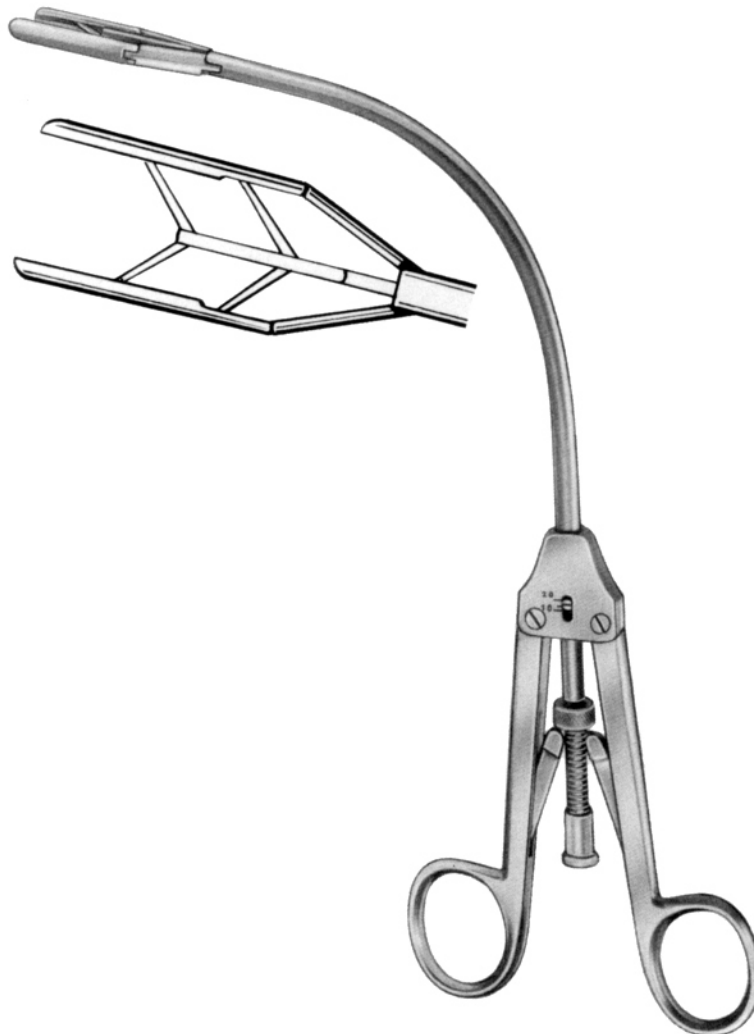

COOLEY blade opening
34.0776.18 5 - 18mm
34.0776.20 6 - 20mm

34.0776.20

34-047

www.hilbro.net

EN Nerve Hooks, Tourniquets, Tunneling Instruments

DE Nervhakchen, Tourniquets, Tunnelier-Instrumente

ES Separadores de nervios, torsniquetes, instrumento para tunelar



CARDIOVASCULAR



CRILE 20.0cm
34.0780.01
34.0780.02

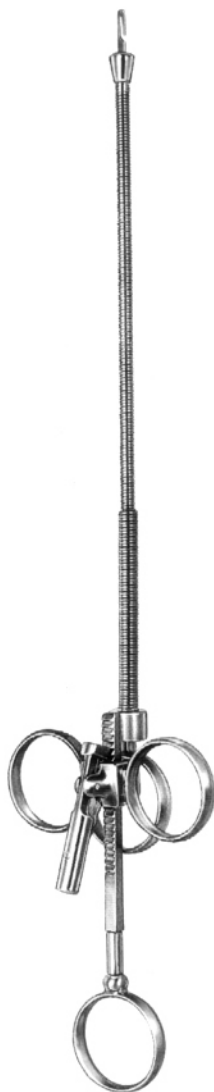

RUMEL-BELMONT 33.0cm
34.0784.32 3.2mm Ø
34.0784.64 6.4mm Ø



26.0cm



34.0786.15
1.5mm



34.0786.25
2.5mm



34.0786.20
2.0mm



34.0786.30
3.0mm



DE BAKEY
34.0790.50 50.0cm

34.0790.50

34-048

www.hilbro.net

CARDIOVASCULAR

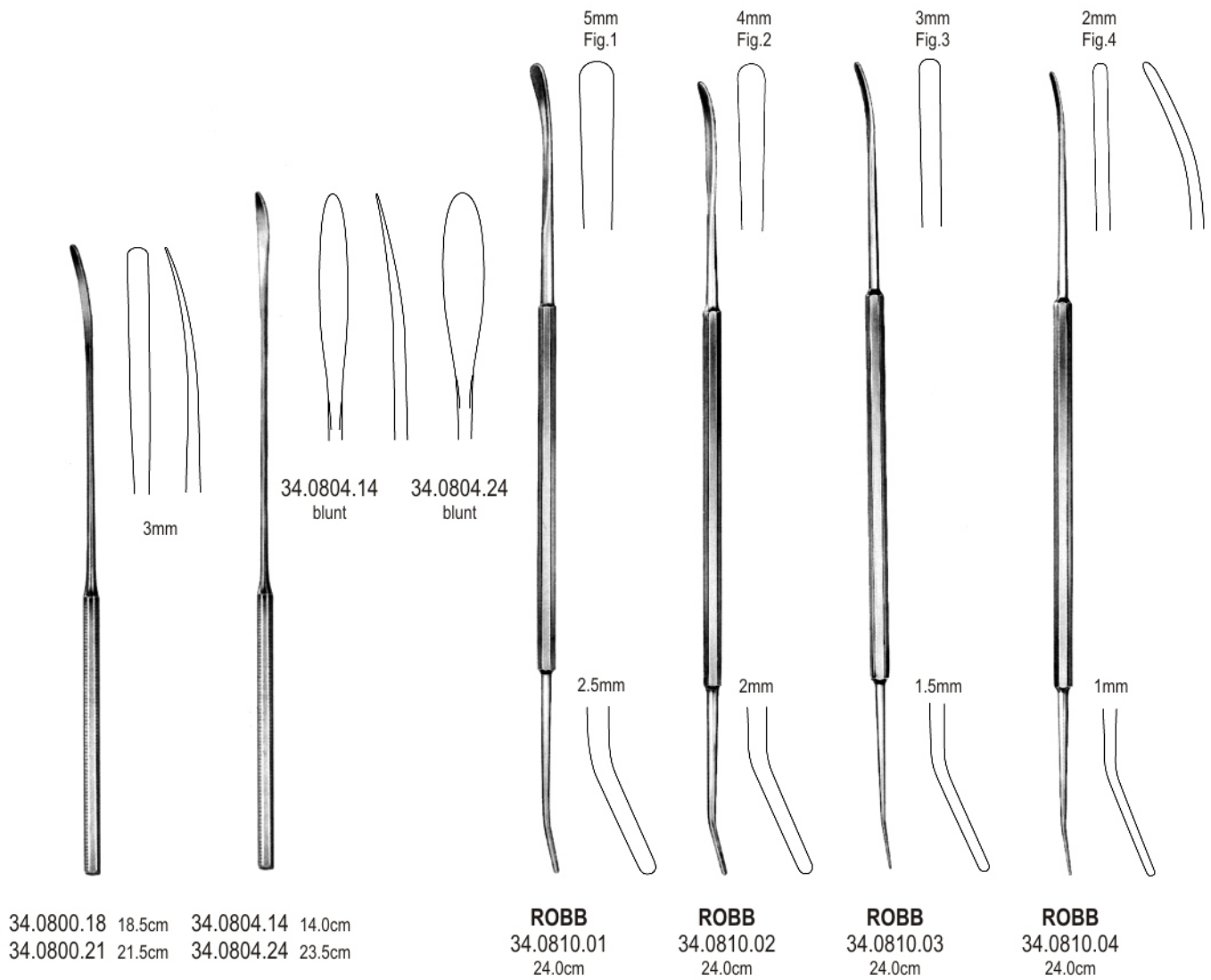

34.0810.04

34-049

www.hilbro.net

CARDIOVASCULAR



COOLEY
13.0cm

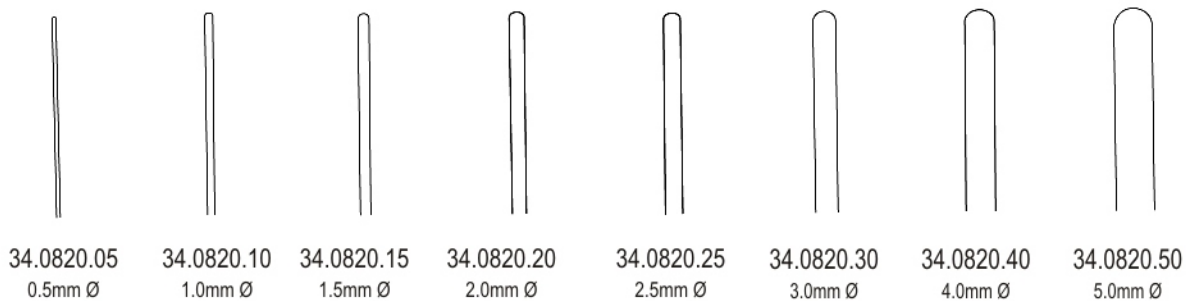

DE BAKEY

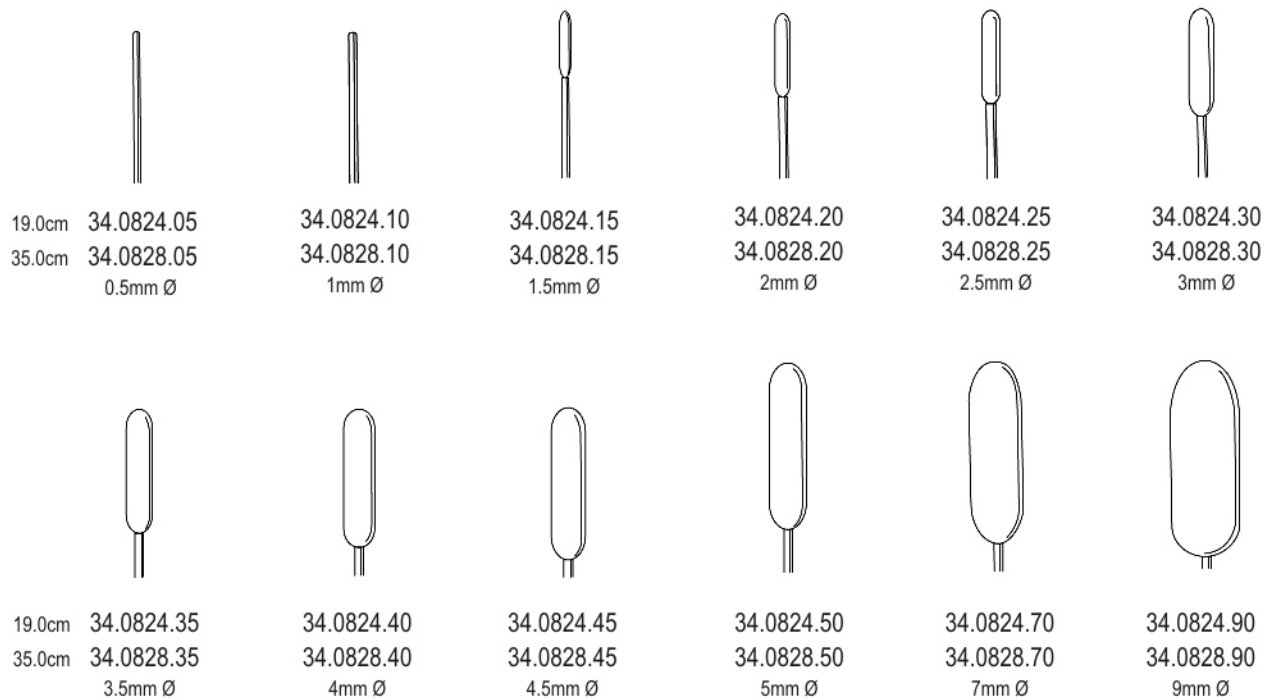

34.0828.90

34-050

www.hilbro.net