



GYNECOLOGY

60



PAGE 001 to 042



- EN Gynecology
- DE Gynäkologie
- ES Ginecología

SERVING HEALTHCARE WORLDWIDE

www.hilbro.net



Vaginal Specula EN

Scheidenspekula DE

Especulos vaginales ES

60

GYNECOLOGY



CUSCO

- 60.0010.01 75 x 17mm
- 60.0010.02 75 x 32mm
- 60.0010.03 85 x 35mm
- 60.0010.04 100 x 37mm

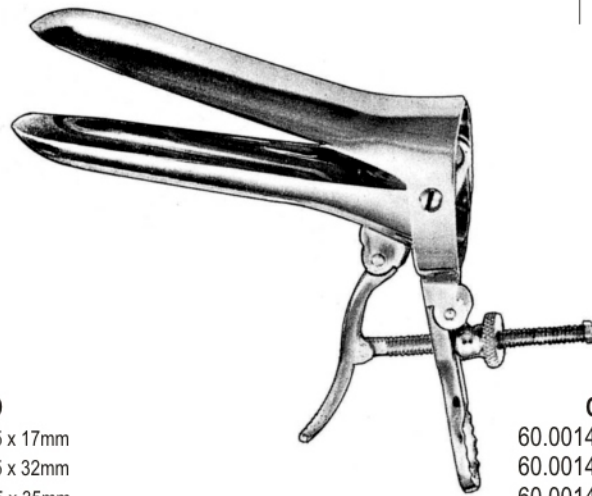

CUSCO

- 60.0014.01 75 x 17mm
- 60.0014.02 75 x 32mm
- 60.0014.03 80 x 32mm
- 60.0014.04 85 x 35mm
- 60.0014.05 110 x 35mm
- 60.0014.06 115 x 37mm



CUSCO

- 60.0020.01 75 x 32mm
- 60.0020.02 85 x 35mm
- 60.0020.03 100 x 35mm
- 60.0020.04 85 x 35mm (with cold light carrier)
- 60.0020.05 (cold light carrier only)



CUSCO

- 60.0022.01 75 x 17mm
- 60.0022.02 85 x 17mm
- 60.0022.03 100 x 17mm



CUSCO (Swiss pattern)

- 60.0024.01 80 x 22mm
- 60.0024.02 100 x 25mm
- 60.0024.03 105 x 27mm
- 60.0024.04 115 x 27mm



CUSCO'S

- 60.0026.01 (LL)
- 60.0026.02 (L)
- 60.0026.03 (M)
- 60.0026.04 (S)
- 60.0026.05 (SS)
- 60.0026.06 (SSS)

60.0026.06

60-001

www.hilbro.net

60

EN Vaginal Specula

DE Scheidenspekula

ES Especulos vaginales

Hilbro

GYNECOLOGY



PEDERSON

60.0030.01 75 x 13mm
60.0030.02 100 x 22mm
60.0030.03 120 x 25mm
60.0030.04 130 x 25mm



GRAVE

60.0034.01 75 x 20mm
60.0034.02 95 x 35mm
60.0034.03 115 x 35mm
60.0034.04 125 x 35mm



SEMM

60.0040.01 100 x 17/20mm
60.0040.02 100 x 25/30mm



FERGUSSON

60.0050.01 25mm Ø
60.0050.02 30mm Ø
60.0050.03 35mm Ø
60.0050.04 40mm Ø

60.0050.04

60-002

www.hilbro.net

Vaginal Specula EN

Scheidenspekula DE

Especulos vaginales ES

60

GYNECOLOGY



for children

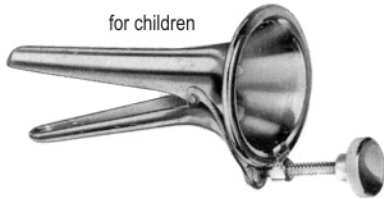

COLLIN
60.0054.01 55 x 10mm



COLLIN
60.0060.01 65 x 20mm

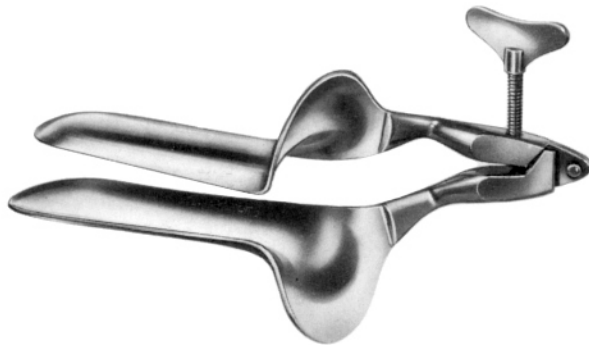

COLLIN-LANDAU
60.0064.01 100 x 35mm



COLLIN
60.0066.01 85 x 30mm
60.0066.02 100 x 35mm
60.0066.03 110 x 40mm
60.0066.04 100 x 35mm (with cold light carrier)
60.0066.05 (cold light carrier only)

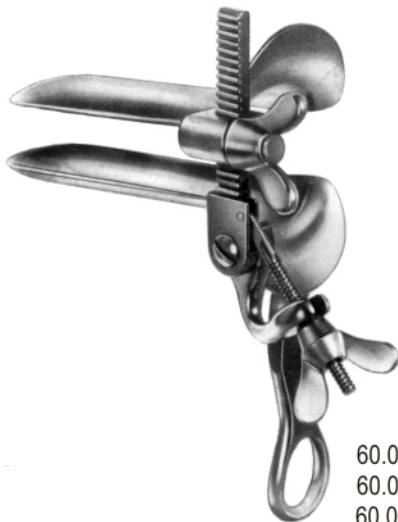

TRELAT
60.0068.01 85 x 33mm
60.0068.02 95 x 35mm
60.0068.03 115 x 43mm



SAKURAI'S
60.0070.01 (LL)
60.0070.02 (L)
60.0070.03 (M)
60.0070.04 (S)

60.0070.04

60-003

www.hilbro.net

EN Vaginal Specula

DE Scheidenspekula

ES Especulos vaginales

GYNECOLOGY

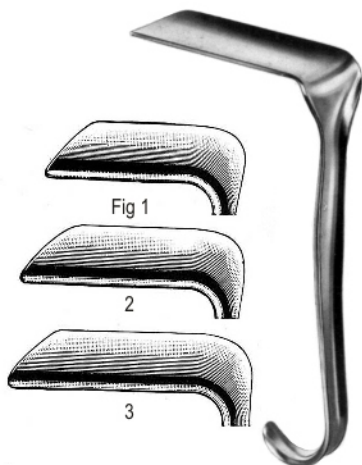

JACKSON

| | |
|------------|------------|
| 60.0080.01 | 75 x 35mm |
| 60.0080.02 | 90 x 35mm |
| 60.0080.03 | 100 x 35mm |
| 60.0080.04 | 75 x 40mm |
| 60.0080.05 | 90 x 40mm |
| 60.0080.06 | 100 x 40mm |

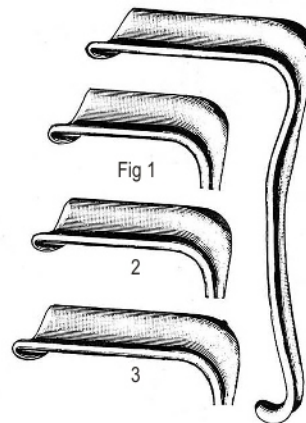

EASTMANN

| | |
|------------|------------|
| 60.0084.01 | 75 x 35mm |
| 60.0084.02 | 90 x 35mm |
| 60.0084.03 | 100 x 35mm |
| 60.0084.04 | 75 x 40mm |
| 60.0084.05 | 90 x 40mm |
| 60.0084.06 | 100 x 40mm |



SIMS

| | |
|------------|--------------------|
| 60.0090.01 | 65 x 25, 70 x 30mm |
| 60.0090.02 | 70 x 30, 70 x 35mm |
| 60.0090.03 | 85 x 35, 90 x 40mm |
| 60.0090.04 | 100 x 35 x 40mm |
| 60.0090.05 | 120 x 35 x 40mm |

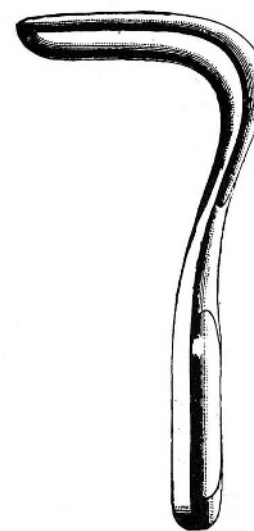

SIMS

| | |
|------------|-----------|
| 60.0094.01 | 60 x 25mm |
| 60.0094.02 | 70 x 30mm |
| 60.0094.03 | 80 x 35mm |

60.0094.03

60-004

www.hilbro.net

Vaginal specula and Retractors EN

Scheidenspekula und halter DE

Especulas y valvas vaginales ES

60

GYNECOLOGY

Hilbro



56 x 13mm

BRAUN

60.0100.18 18.0cm

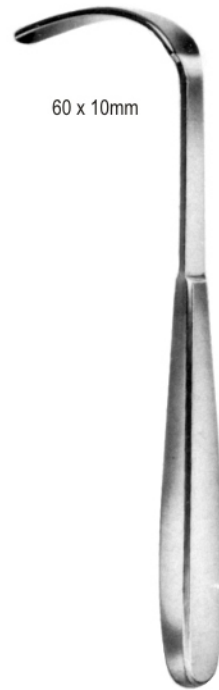

60 x 10mm

BRAUN

60.0102.18 18.0cm

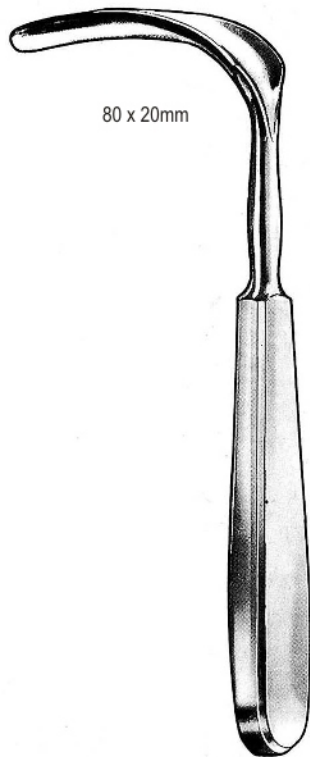

80 x 20mm

ULRICH

60.0110.19 19.5cm

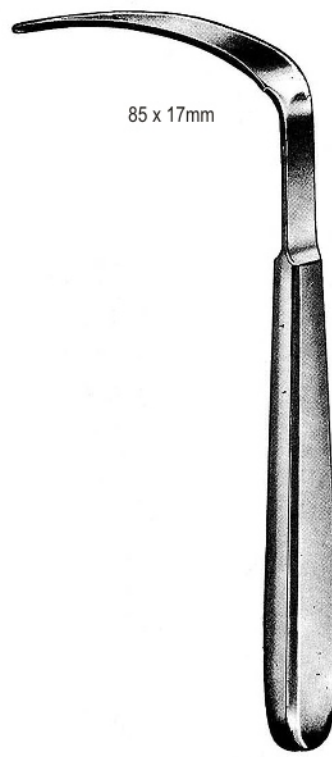

85 x 17mm

60.0112.19 19.0cm

60.0112.19

60-005

www.hilbro.net



KRISTELLER
specula

Fig 1. 60.0120.01 110 x 18mm
Fig 2. 60.0120.02 110 x 21mm



KRISTELLER
retractors

Fig 1. 60.0122.01 115 x 14mm
Fig 2. 60.0122.02 115 x 17mm



KRISTELLER
set of 1 speculum and 1 retractor each

Fig 1. 60.0124.00
Fig 2. 60.0126.00



KRISTELLER
specula

Fig.1 60.0130.01 70 x 27mm
Fig.2 60.0130.02 80 x 30mm
Fig.3 60.0130.03 90 x 36mm



KRISTELLER
retractors

Fig.1 60.0132.01 75 x 23mm
Fig.2 60.0132.02 85 x 26mm
Fig.3 60.0132.03 100 x 32mm



KRISTELLER
set of 1 speculum and 1 retractors each

Fig.1 60.0134.00
Fig.2 60.0136.00
Fig.3 60.0138.00

60.0138.00

60-006

www.hilbro.net

GYNECOLOGY



KRISTELLER
specula

- 60.0140.01 110 x 27mm
- 60.0140.02 110 x 30mm
- 60.0140.03 110 x 36mm



KRISTELLER
retractors

- 60.0142.01 115 x 23mm
- 60.0142.02 115 x 26mm
- 60.0142.03 115 x 32mm



KRISTELLER

- set of 1 speculum and 1 retractor each
- 60.0144.00
 - 60.0146.00
 - 60.0148.00



KRISTELLER
specula

- Fig.1 60.0150.01 105 x 26mm
- Fig.2 60.0150.02 105 x 28mm
- Fig.3 60.0150.03 105 x 33mm



KRISTELLER
retractors

- Fig.1 60.0152.01 115 x 22mm
- Fig.2 60.0152.02 115 x 24mm
- Fig.3 60.0152.03 115 x 29mm



KRISTELLER

- set of 1 speculum and 1 retractors each
- Fig.1 60.0154.00
 - Fig.2 60.0156.00
 - Fig.3 60.0158.00

60.0158.00

60-007

www.hilbro.net

60

EN Vaginal Specula and Retractors

DE Scheidenspekula und halter

ES Especulos y valvas vaginales

Hilbro

GYNECOLOGY

extra large pattern



60.0160.01
140 x 30mm



60.0162.01
135 x 36mm



60.0164.01
135 x 36mm

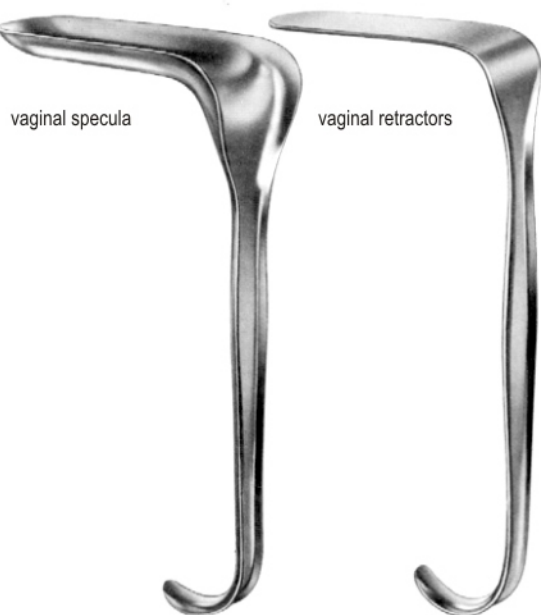

vaginal specula

vaginal retractors

KALLMORGEN

60.0170.01 70 x 40mm

60.0170.02 90 x 40mm

set

60.0174.00

60.0176.00

60.0172.01 70 x 33mm

60.0172.02 90 x 33mm



vaginal specula

vaginal retractors

MATHIEU

60.0180.01 95 x 16mm

95 x 26mm

60.0180.02 95 x 26mm

95 x 30mm

60.0182.01 100 x 11mm

100 x 20mm

60.0182.02 100 x 14mm

100 x 26mm

set

60.0184.00

60.0186.00

60.0186.00

60-008

www.hilbro.net

Vaginal Specula EN

Scheidenspekula DE

Especulos vaginales ES

60

GYNECOLOGY

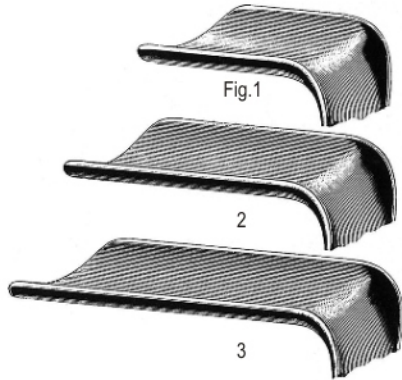

Fig.1

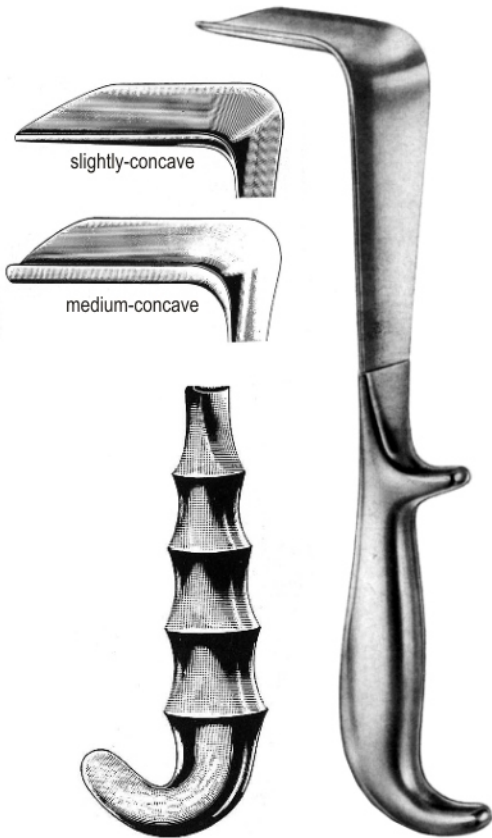

Fig.2



Fig.3



DOYEN

60.0220.01 75 x 45mm
60.0220.02 90 x 45mm
60.0220.03 110 x 45mm

DOYEN FG DOYEN

| Fig | mm | mm | slightly-concave | slightly-concave | medium-concave |
|-----|-----|----|------------------|------------------|----------------|
| 1 | 55 | 35 | 60.0190.01 | 60.0200.01 | 60.0210.01 |
| 2 | 85 | 35 | 60.0190.02 | 60.0200.02 | 60.0210.02 |
| 3 | 115 | 35 | 60.0190.03 | 60.0200.03 | 60.0210.03 |
| 1 | 55 | 45 | 60.0192.01 | 60.0202.01 | 60.0212.01 |
| 2 | 85 | 45 | 60.0192.02 | 60.0202.02 | 60.0212.02 |
| 3 | 115 | 45 | 60.0192.03 | 60.0202.03 | 60.0212.03 |
| 1 | 55 | 60 | 60.0194.01 | 60.0204.01 | 60.0214.01 |
| 2 | 85 | 60 | 60.0194.02 | 60.0204.02 | 60.0214.02 |
| 3 | 115 | 60 | 60.0194.03 | 60.0204.03 | 60.0214.03 |

60.0220.03

60-009

www.hilbro.net

60

EN Vaginal Specula

DE Scheidenspekula

ES Especulos vaginales

Hilbro

GYNECOLOGY

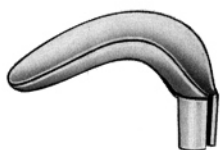

60.0230.01

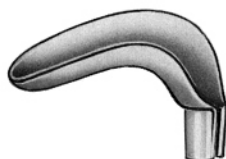

60.0230.02

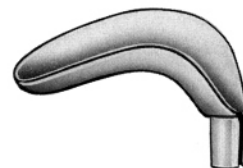

60.0230.03



60.0230.04



60.0230.05

60.0230.40
weight, light, 400gm
60.0230.80
weight, heavy, 800gm

SCHERBAK

60.0230.00 set complete

60.0230.10 handle only



A
60.0242.10
handle only



70 x 30mm
60.0244.01



80 x 35mm
60.0244.02



90 x 35mm
60.0244.03



100 x 35mm
60.0244.04



80 x 30mm
60.0244.05



85 x 33mm
60.0244.06



100 x 35mm
60.0244.07



110 x 42mm
60.0244.08



B
60.0244.10
handle only

BOZEMANN

60.0240.00 compl. set with handle A, B and 8 blades

60.0242.00 compl. set with handle A and 8 blades

60.0244.00 compl. set with handle B and 8 blades

60.0244.10

60-010

www.hilbro.net

Vaginal Specula EN

Scheidenspekula DE

Especulos vaginales ES

60

GYNECOLOGY

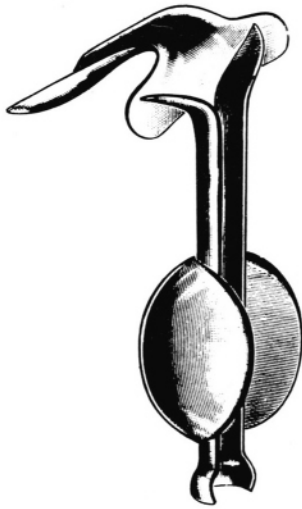

AUVARD

60.0250.01 80 x 38mm 2 lbs
60.0250.02 80 x 38mm 2.5 lbs
60.0250.03 80 x 38mm 3 lbs



AUVARD

60.0254.00 68 x 40mm 3 lbs



80 x 38 mm

AUVARD

60.0260.01 2.5 lbs
60.0260.02 3 lbs



STEINER-AUVARD

60.0264.01 140 x 35mm 2.5 lbs
60.0266.01 140 x 35mm 2.5 lbs
laser pattern

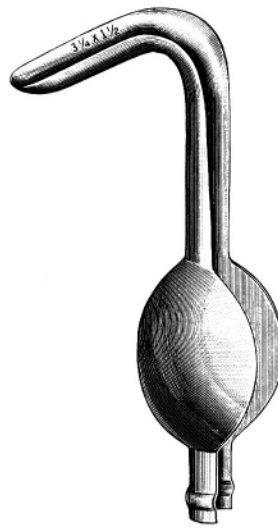

HENROTIN

60.0270.01 80 x 35mm 3 lbs
30° blade angled down

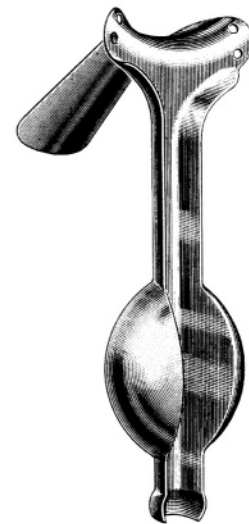

BERLIND-AUVARD

60.0274.01 105 x 40mm 2.5 lbs

60.0274.01

60-011

www.hilbro.net

60

EN Vaginal Specula and Retractors

DE Scheidenspekula und halter

ES Especulos y valvas vaginales

Hilbro

GYNECOLOGY



LANDAU

60.0300.01 105 x 28mm
60.0300.02 105 x 38mm



BREISKY

60.0304.01 100 x 20mm
60.0304.02 100 x 25mm
60.0304.03 100 x 30mm
60.0304.04 100 x 35mm
60.0304.05 100 x 40mm

60.0306.01 130 x 20mm
60.0306.02 130 x 25mm
60.0306.03 130 x 30mm
60.0306.04 130 x 35mm
60.0306.05 130 x 40mm

60.0308.01 155 x 40mm



95 x 45 cm

DUNKEL
60.0310.22

60.0310.22

60-012

www.hilbro.net



O'SULLIVAN-O'CONNOR
60.0314.00 set complete



60.0314.01 Fig. 1 = 45 x 17mm
60.0314.02 Fig. 2 = 90 x 37mm
60.0314.03 Fig. 3 = 90 x 45mm

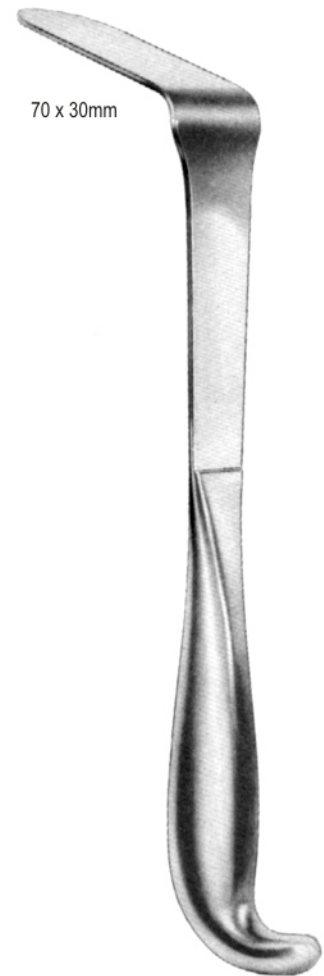

DOYEN
60.0320.24 24.0cm

EN Retractors, Endospecula

DE Wundspreizer, Vulvaspreizer, Endospekula

ES Separadores, endospeculos



GYNECOLOGY



FRIEDMAN
60.0324.10 10.0cm

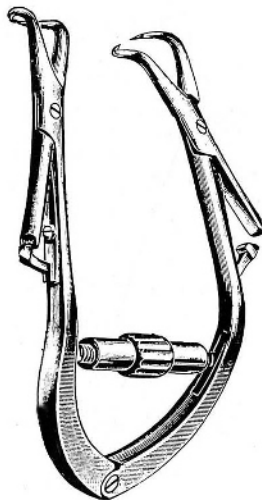

JOLL
60.0330.15 15.0cm

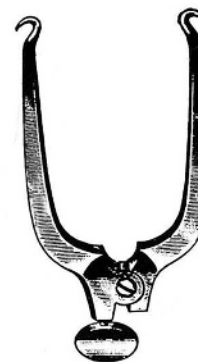

COMYNS-BERKELEY
60.0334.00

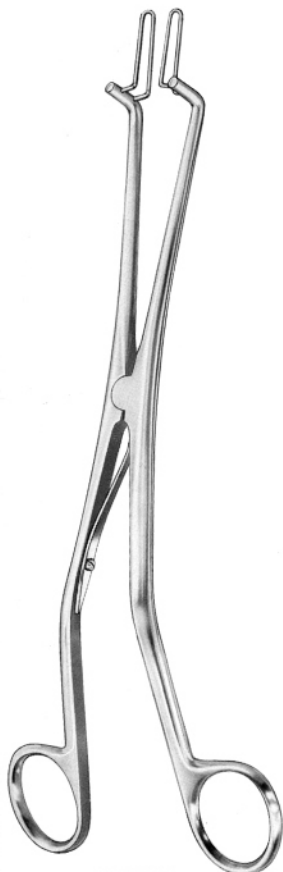

KOGAN
24.0cm
60.0340.24 2/4mm
60.0340.48 4/8mm



KOGAN
24.0cm laser
60.0344.24 2/4mm 60.0346.24
60.0344.48 4/8mm 60.0346.48

60.0346.48

60-014

www.hilbro.net

GYNECOLOGY



HEGAR
60.0350.01 - 60.0350.30
(1.0mm - 30.0mm)

| | mm dia. | | mm dia. |
|------------|---------|------------|---------|
| 60.0350.01 | 1.0 | 60.0351.01 | 1.5 |
| 60.0350.02 | 2.0 | 60.0351.02 | 2.5 |
| 60.0350.03 | 3.0 | 60.0351.03 | 3.5 |
| 60.0350.04 | 4.0 | 60.0351.04 | 4.5 |
| 60.0350.05 | 5.0 | 60.0351.05 | 5.5 |
| 60.0350.06 | 6.0 | 60.0351.06 | 6.5 |
| 60.0350.07 | 7.0 | 60.0351.07 | 7.5 |
| 60.0350.08 | 8.0 | 60.0351.08 | 8.5 |
| 60.0350.09 | 9.0 | 60.0351.09 | 9.5 |
| 60.0350.10 | 10.0 | 60.0351.10 | 10.5 |
| 60.0350.11 | 11.0 | 60.0351.11 | 11.5 |
| 60.0350.12 | 12.0 | 60.0351.12 | 12.5 |
| 60.0350.13 | 13.0 | 60.0351.13 | 13.5 |
| 60.0350.14 | 14.0 | 60.0351.14 | 14.5 |
| 60.0350.15 | 15.0 | 60.0351.15 | 15.5 |
| 60.0350.16 | 16.0 | 60.0351.16 | 16.5 |
| 60.0350.17 | 17.0 | 60.0351.17 | 17.5 |
| 60.0350.18 | 18.0 | 60.0351.18 | 18.5 |
| 60.0350.19 | 19.0 | 60.0351.19 | 19.5 |
| 60.0350.20 | 20.0 | 60.0351.20 | 20.5 |
| 60.0350.21 | 21.0 | 60.0351.21 | 21.5 |
| 60.0350.22 | 22.0 | 60.0351.22 | 22.5 |
| 60.0350.23 | 23.0 | 60.0351.23 | 23.5 |
| 60.0350.24 | 24.0 | 60.0351.24 | 24.5 |
| 60.0350.25 | 25.0 | 60.0351.25 | 25.5 |
| 60.0350.26 | 26.0 | 60.0351.26 | 26.5 |
| 60.0350.27 | 27.0 | 60.0351.27 | 27.5 |
| 60.0350.28 | 28.0 | 60.0351.28 | 28.5 |
| 60.0350.29 | 29.0 | 60.0351.29 | 29.5 |
| 60.0350.30 | 30.0 | 60.0351.30 | 30.5 |

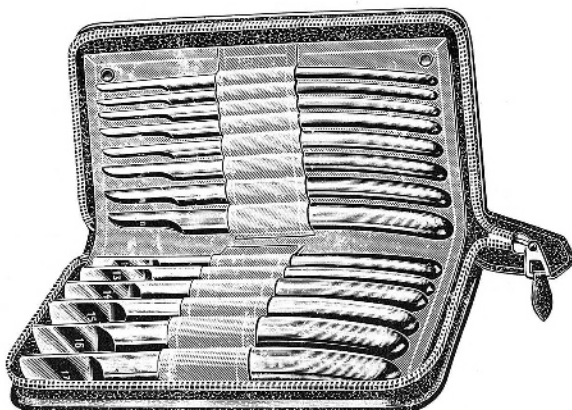

HEGAR
60.0350.00 (4 to 17 mm dia)
set of 14

60.0352.00 (1 to 26 mm dia)
set of 26

60.0354.00 (1 to 30 mm dia)
set of 30

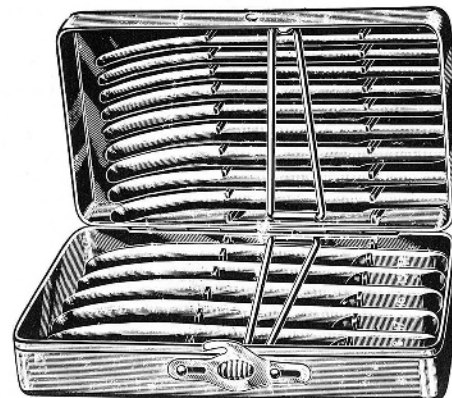

HEGAR
60.0360.00 (4 to 17 mm dia)
set of 14

60.0362.00 (1 to 26 mm dia)
set of 26

60.0364.00 (1 to 30 mm dia)
set of 30

60.0364.00

60-015

www.hilbro.net

60

EN Uterine Dilators

DE Uterus-Dilatatoren

ES Dilatadores uterinos

Hilbro

GYNECOLOGY



HEGAR

60.0370.01 - 60.0370.25
(1/2 - 25/26 mm dia.)

| | mm dia. |
|------------|---------|
| 60.0370.01 | 1/2 |
| 60.0370.03 | 3/4 |
| 60.0370.05 | 5/6 |
| 60.0370.07 | 7/8 |
| 60.0370.09 | 9/10 |
| 60.0370.11 | 11/12 |
| 60.0370.13 | 13/14 |
| 60.0370.15 | 15/16 |
| 60.0370.17 | 17/18 |
| 60.0370.19 | 19/20 |
| 60.0370.21 | 21/22 |
| 60.0370.23 | 23/24 |
| 60.0370.25 | 25/26 |

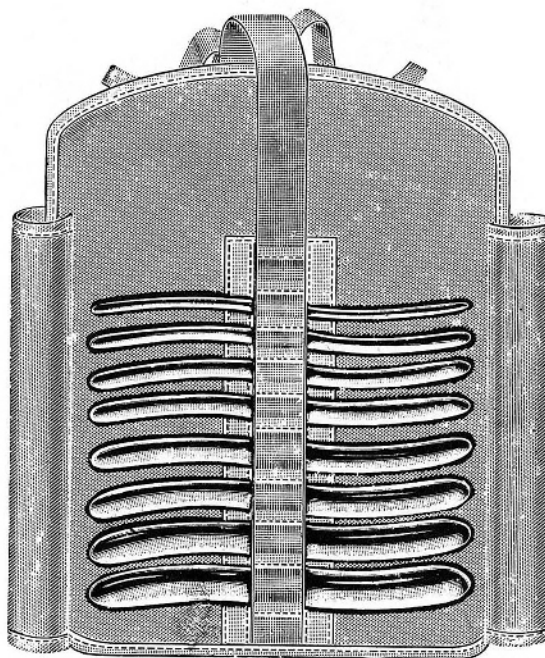

HEGAR

60.0370.00 60.0372.00
set of 8 set of 13
(3/4 to 17/18 mm dia) (1/2 to 25/26 mm dia)

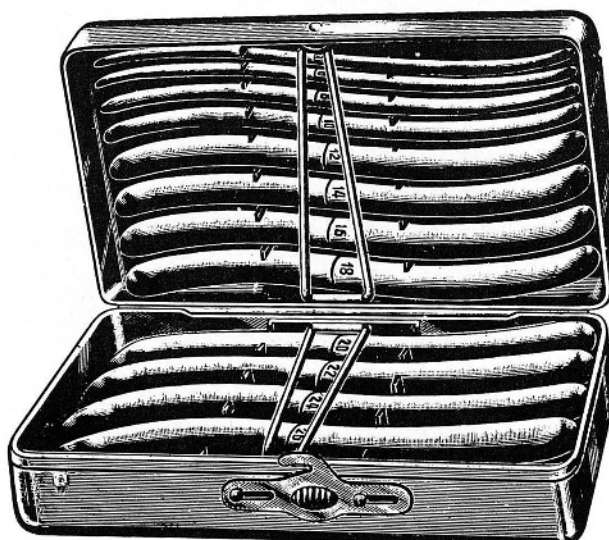

HEGAR

60.0380.00 60.0382.00
set of 8 set of 13
(3/4 to 17/18 mm dia) (1/2 to 25/26 mm dia)

60.0382.00

60-016

www.hilbro.net

GYNECOLOGY

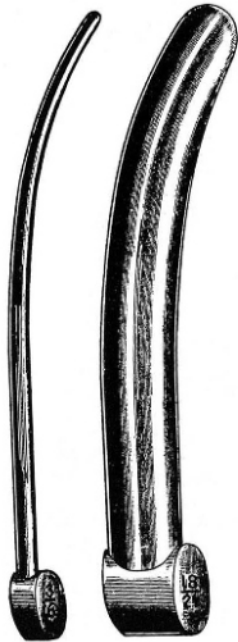

| | mm dia. |
|------------|---------|
| 60.0390.01 | 3/6 |
| 60.0390.02 | 4/7 |
| 60.0390.03 | 5/8 |
| 60.0390.04 | 6/9 |
| 60.0390.05 | 7/10 |
| 60.0390.06 | 8/11 |
| 60.0390.07 | 9/12 |
| 60.0390.08 | 10/13 |
| 60.0390.09 | 11/14 |
| 60.0390.10 | 12/15 |
| 60.0390.11 | 13/16 |
| 60.0390.12 | 14/17 |
| 60.0390.13 | 15/18 |
| 60.0390.14 | 16/19 |
| 60.0390.15 | 17/20 |
| 60.0390.16 | 18/21 |

HAWKINS-AMBLER

60.0390.00 set of 12

60.0392.00 set of 16



| | |
|------------|--------------|
| 60.0400.01 | 3-7 mm dia |
| 60.0400.02 | 5-9 mm dia |
| 60.0400.03 | 7-12 mm dia |
| 60.0400.04 | 9-15 mm dia |
| 60.0400.05 | 12-18 mm dia |

JOLLY

60.0400.00 set of 5



| | | |
|-----------|------------|-----------|
| Fig.9/10 | 60.0404.01 | 4,5/5 mm |
| Fig.11/12 | 60.0404.02 | 5,5/6 mm |
| Fig.13/14 | 60.0404.03 | 6,5/7 mm |
| Fig.15/16 | 60.0404.04 | 7,5/8 mm |
| Fig.17/18 | 60.0404.05 | 8,5/9 mm |
| Fig.19/20 | 60.0404.06 | 9,5/10 mm |

HANK

60.0404.00 set

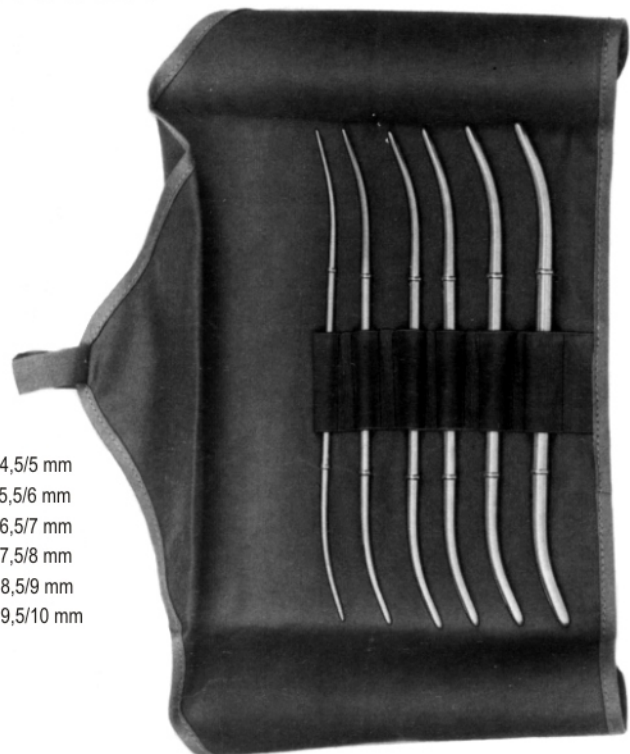

HANK

60.0406.00 set

60.0406.00

60-017

www.hilbro.net

60

EN Uterine Dilators

DE Uterus-Dilatatoren

ES Dilataores uterinos

Hilbro

GYNECOLOGY

| mm | |
|----|------------|
| 1 | 60.0410.01 |
| 2 | 60.0410.02 |
| 3 | 60.0410.03 |
| 4 | 60.0410.04 |
| 5 | 60.0410.05 |
| 6 | 60.0410.06 |
| 7 | 60.0410.07 |
| 8 | 60.0410.08 |
| 9 | 60.0410.09 |
| 10 | 60.0410.10 |
| 11 | 60.0410.11 |
| 12 | 60.0410.12 |
| 13 | 60.0410.13 |
| 14 | 60.0410.14 |
| 15 | 60.0410.15 |
| 16 | 60.0410.16 |
| 17 | 60.0410.17 |
| 18 | 60.0410.18 |
| 19 | 60.0410.19 |
| 20 | 60.0410.20 |



HEGAR set

- 60.0410.00 1 to 13mm
- 60.0412.00 1 to 20mm
- 60.0414.00 14 to 20mm

60.0414.00

60-018

www.hilbro.net

Uterine Dilators EN

Uterus-Dilatatoren DE

Dilatadores uterinos ES

60

GYNECOLOGY

Hilbro

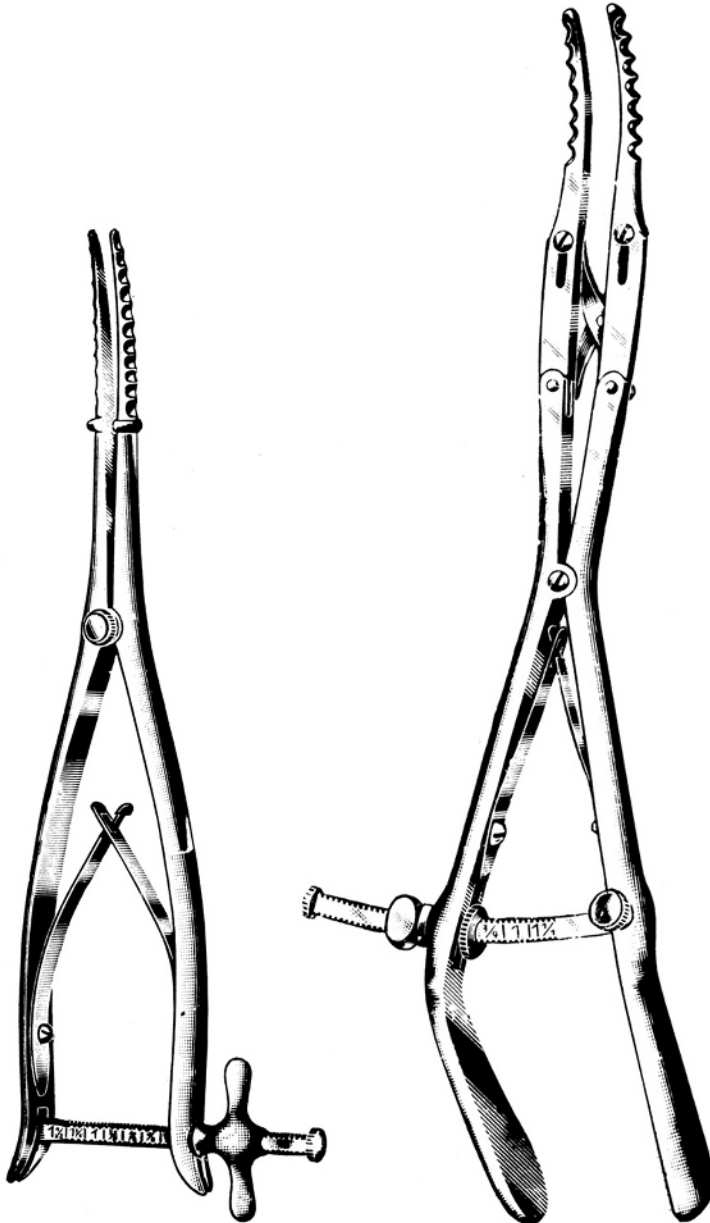

WYLIE

60.0420.29 serrated
60.0422.29 smooth
29.0cm

GOODELL

60.0426.34 34.0cm

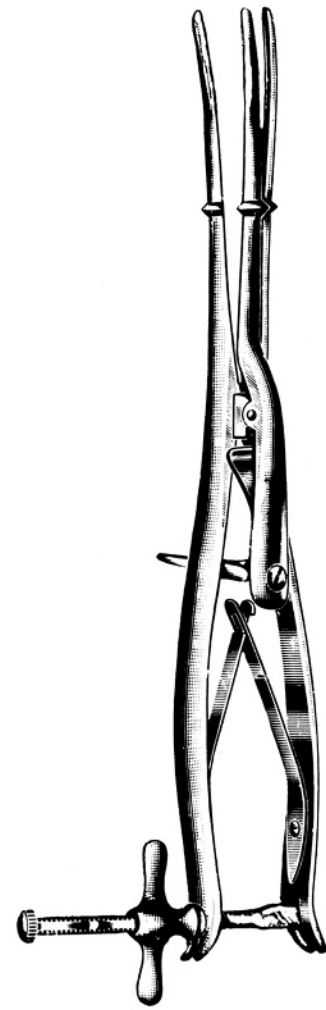

SIMS

60.0430.29 29.0cm

60.0430.29

60-019

www.hilbro.net

60

EN Uterine Depressors, Gauze Packer and Sponge Holder
DE Uterusdepressoren, Tamponstopfer und Schwammhalter
ES Depresores uterinos, Porta-tapones y esponjas

Hilbro

GYNECOLOGY



BRAUN
60.0440.28 28.0cm



SIMS
60.0444.26 26.0cm



FANO
60.0450.22 22.0cm

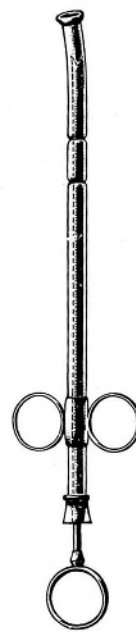

RAPID
60.0454.01 200 x 8mm
60.0454.02 250 x 10mm
60.0454.03 250 x 12mm



SIMS
60.0460.27 27.0cm

60.0460.27

60-020

www.hilbro.net

Uterine Sounds EN

Uterussonden DE

Histerometros ES

60

GYNECOLOGY

Hilbro

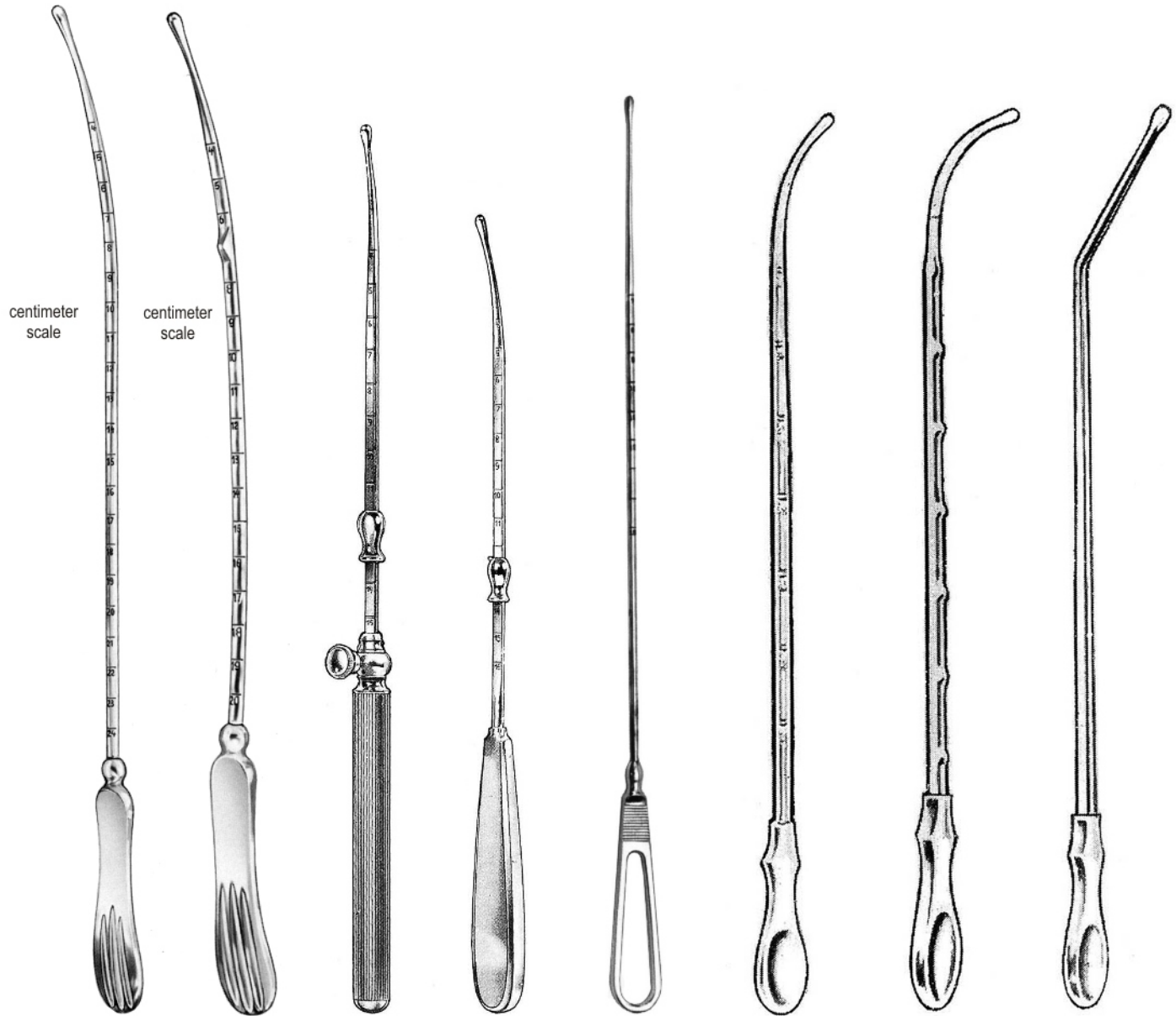

SIMS
32.0cm
60.0470.32
rigid

60.0472.32
malleable

MARTIN
32.0cm
60.0476.32
rigid

60.0478.32
malleable

COLLIN
60.0480.28
28.0cm

VALLEIX
60.0486.25
25.0cm

60.0490.30
30.5cm

GALABIN
60.0496.32
32.0cm

HORROCKS
60.0500.32
32.0cm

SIMPSON
60.0504.32
32.0cm

60.0504.32

60-021

www.hilbro.net

60

EN Myoma Instruments

DE Myom-Instrumente

ES Instrumentos para fibroma

Hilbro

GYNECOLOGY



DOYEN

17.0cm

60.0510.01 T-handle
60.0510.02 loop handle

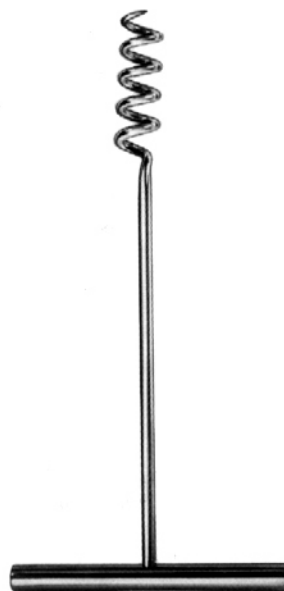

DOYEN

17.0cm

60.0512.01 T-handle
60.0512.02 loop handle



SEGOND

60.0516.27 27.0cm

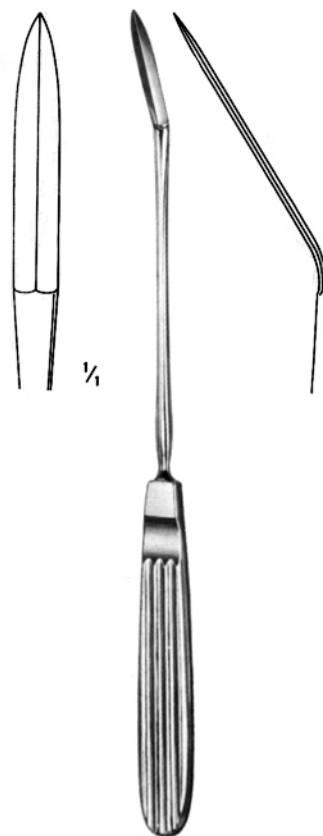

AYRE

60.0520.23 23.0cm

60.0520.23

60-022

www.hilbro.net

Fistula Hooks EN

Fistelhaken DE

Ganchos p/fistulas ES

60

GYNECOLOGY



60.0524.01

60.0524.02

60.0524.03

60.0524.04

60.0524.05

EMMET
22.0cm



60.0526.24 24.0cm



SIMON
60.0530.22 22.0cm



SIMON
60.0532.22 22.0cm

60.0532.22

60-023

www.hilbro.net

60

EN Tenaculum Forceps

DE Hakenzangen

ES Pinzas para coger el cuello del utero

Hilbro

GYNECOLOGY



POZZI
60.0540.25 25.0cm

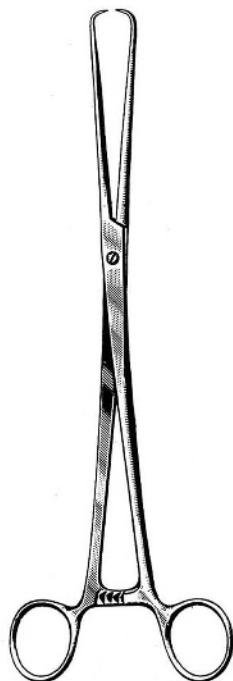

POZZI
60.0542.25 25.0cm

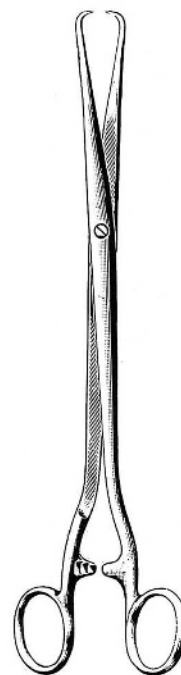

SCHROEDER
60.0546.25 25.0cm



STAUDE-MOORE
60.0550.17 17.0cm
strong pattern

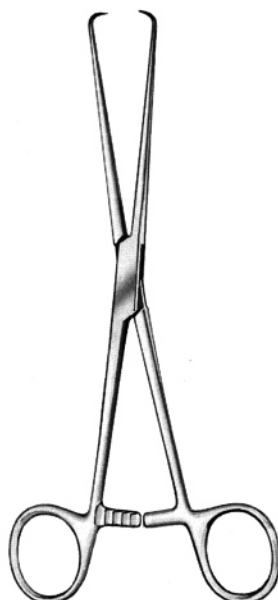

BARRETT
60.0554.18 18.0cm

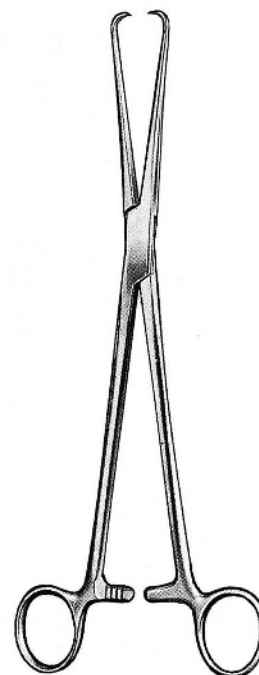

POZZI
60.0560.25 25.5cm

60.0560.25

60-024

www.hilbro.net

GYNECOLOGY

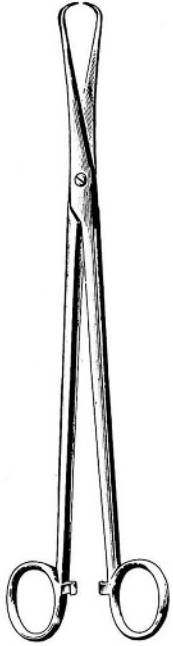

MARTIN
60.0564.27 27.0cm



SKENE
60.0570.24 24.0cm

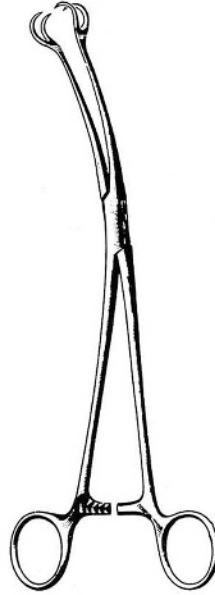

SKENE
60.0574.23 23.0cm



ABEL
60.0576.27 27.0cm



SCHROEDER
60.0580.25 25.0cm



BRAUN
60.0584.25 25.0cm



DUPLAY
60.0590.28 28.0cm



BEACHAM
60.0594.26 26.0cm

60.0594.26

60-025

www.hilbro.net

GYNECOLOGY

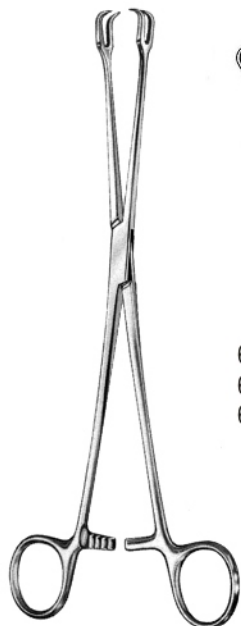

SCHROEDER
 60.0600.23 23.0cm
 60.0600.24 24.0cm
 60.0600.26 26.0cm

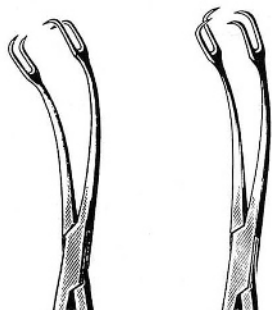

60.0601.23 23.0cm 60.0603.23
 60.0601.24 24.0cm 60.0603.24
 60.0601.26 26.0cm 60.0603.26

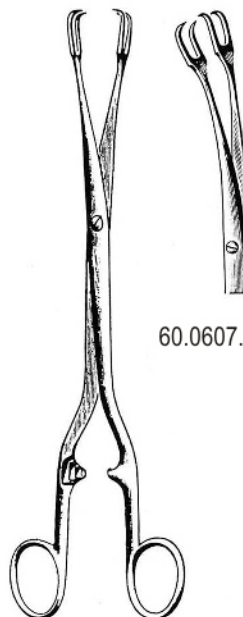

SCHROEDER
 60.0606.26 26.0cm

60.0607.26 26.0cm

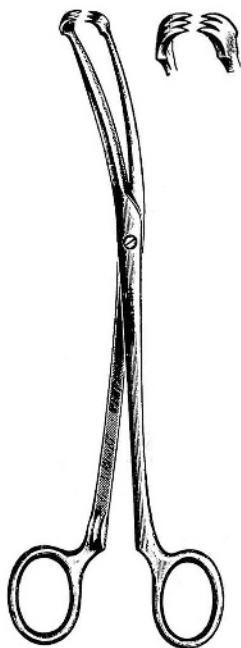

TEALE
 60.0610.18 18.0cm
 60.0610.23 23.0cm



TEALE
 60.0614.18 18.0cm
 60.0614.23 23.0cm
 60.0614.25 25.0cm

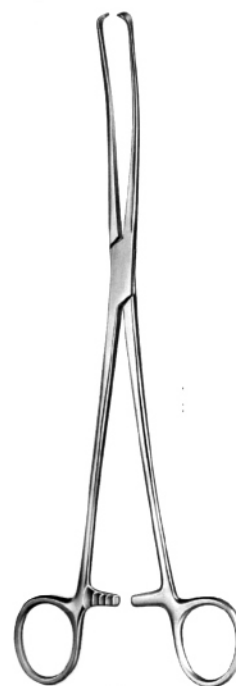

IOWA
 60.0620.26 26.0cm

60.0620.26

60-026

www.hilbro.net

Tenaculum Forceps EN

Hakenzangen DE

Pinzas para coger el cuello del utero ES

60

GYNECOLOGY

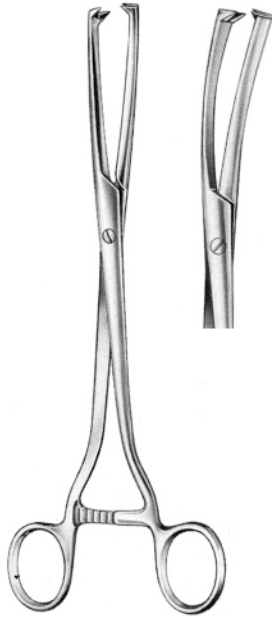

6mm



8mm



10mm

MUSEUX

| straight | 24.0cm | curved sideway |
|------------|--------|----------------|
| 60.0630.06 | 6mm | 60.0631.06 |
| 60.0630.08 | 8mm | 60.0631.08 |
| 60.0630.10 | 10mm | 60.0631.10 |

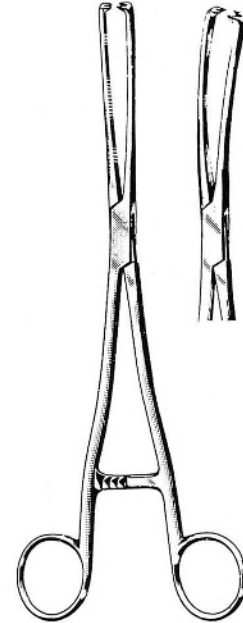

MUSEUX

| straight | 24.0cm | curved sideway |
|------------|--------|----------------|
| 60.0634.06 | 6mm | 60.0635.06 |
| 60.0634.08 | 8mm | 60.0635.08 |
| 60.0634.10 | 10mm | 60.0635.10 |

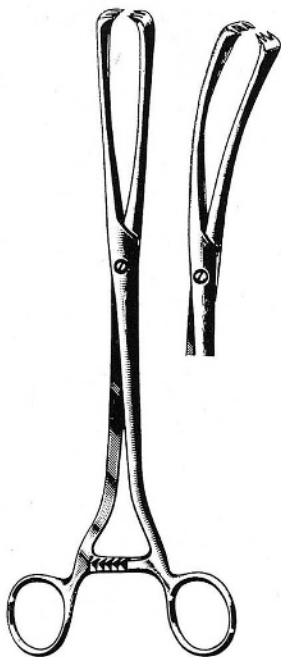

9mm



11mm



13mm

MUSEUX

| straight | 26.0cm | curved sideway |
|------------|--------|----------------|
| 60.0638.09 | 9mm | 60.0639.09 |
| 60.0638.11 | 11mm | 60.0639.11 |
| 60.0638.13 | 13mm | 60.0639.13 |

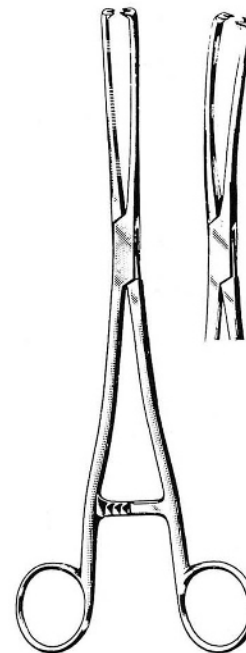

MUSEUX

| straight | 26.0cm | curved sideway |
|------------|--------|----------------|
| 60.0642.09 | 9mm | 60.0643.09 |
| 60.0642.11 | 11mm | 60.0643.11 |
| 60.0642.13 | 13mm | 60.0643.13 |

60.0643.13

60-027

www.hilbro.net

- EN Tenaculum Forceps
- DE Hakenzangen
- ES Pinzas para coger el cuello del utero

GYNECOLOGY



JACOBS
60.0646.21 21.0cm 60.0647.21



HENROTIN
60.0650.20 20.0cm



BRAUN
60.0654.15 15.5cm



CZERNY
60.0660.20 20.5cm



60.0664.26 26.0cm

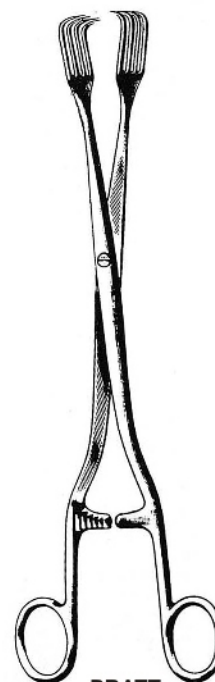

PRATT
60.0668.28 28.0cm

60.0668.28

60-028

www.hilbro.net

GYNECOLOGY

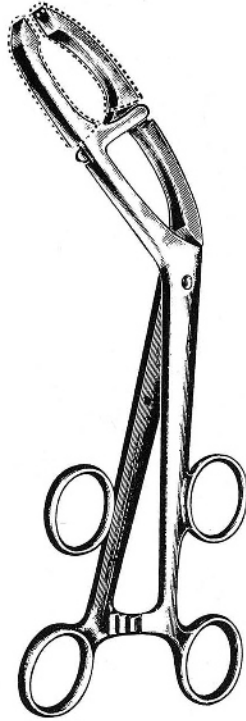

BONNEY
60.0672.27 27.0cm

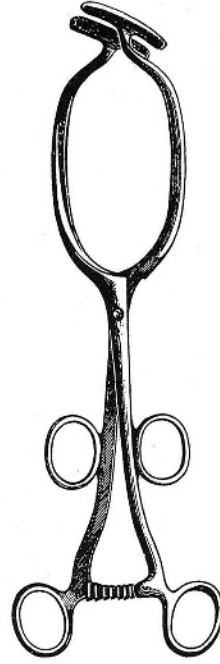

BONNEY
60.0674.27 27.0cm

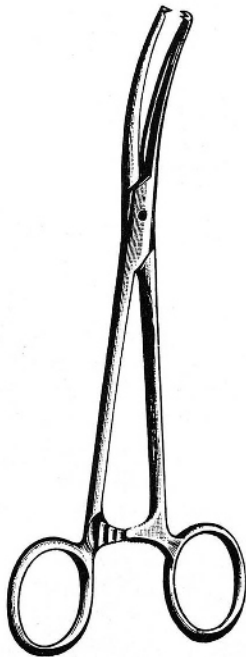

MAINGOT
60.0676.20 20.0cm 60.0677.20
60.0676.24 24.0cm 60.0677.24

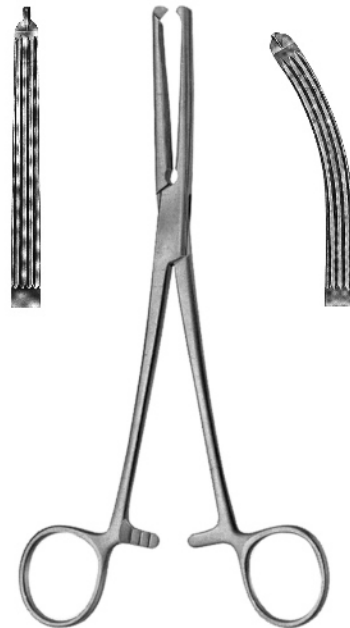

GWILLIAM
60.0678.20 20.0cm 60.0679.20

60.0679.20

60-029

www.hilbro.net

EN Uterine Polypus and Elevating Forceps

DE Uterus Polypen und Fasszangen

ES Pinzas para polipos el uterinos

GYNECOLOGY



KELLY
60.0684.32 32.0cm

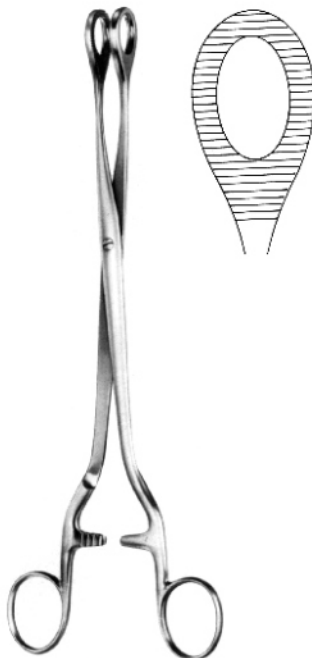

NOTO
60.0690.27 27.0cm

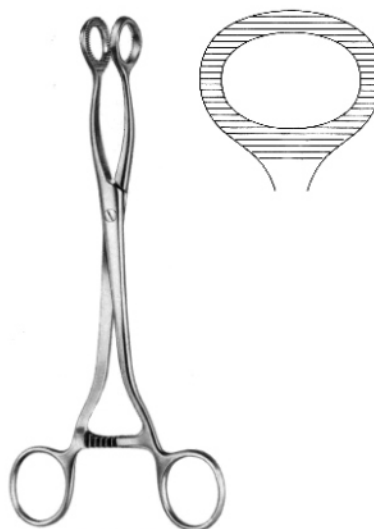

DOYEN
60.0694.20 20.0cm



DARTIGUES
60.0700.27 27.0cm



SOMER
60.0704.23 23.0cm

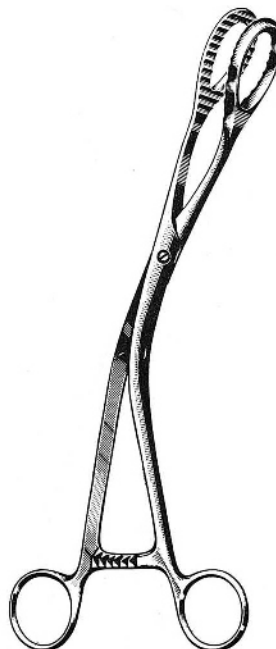

PRUESMANN
60.0710.27 27.5cm



COLLIN
60.0714.25 25.0cm

60.0714.25

60-030

www.hilbro.net

GYNECOLOGY



THOMS-GAYLOR
60.0750.24 24.0cm



THOMS-GAYLOR
60.0754.22 22.0cm
60.0754.24 24.0cm



60.0760.01

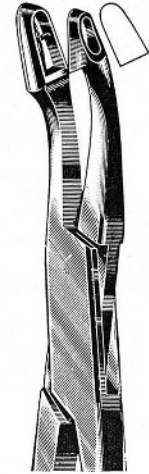

60.0760.02

VAN DOREN
24.0cm



GELLHORN
60.0764.23 23.0cm



FAURE
60.0770.21 21.0cm



SCHUBERT
60.0774.26 26.0cm



SCHUBERT
60.0778.21 21.0cm
60.0778.29 29.0cm

60.0778.29

60-031

www.hilbro.net

EN Cervical Biopsy and Specimen Forceps

DE Probeexzisionszangen

ES Pinzas saca-bocados para biopsia

Hilbro

GYNECOLOGY

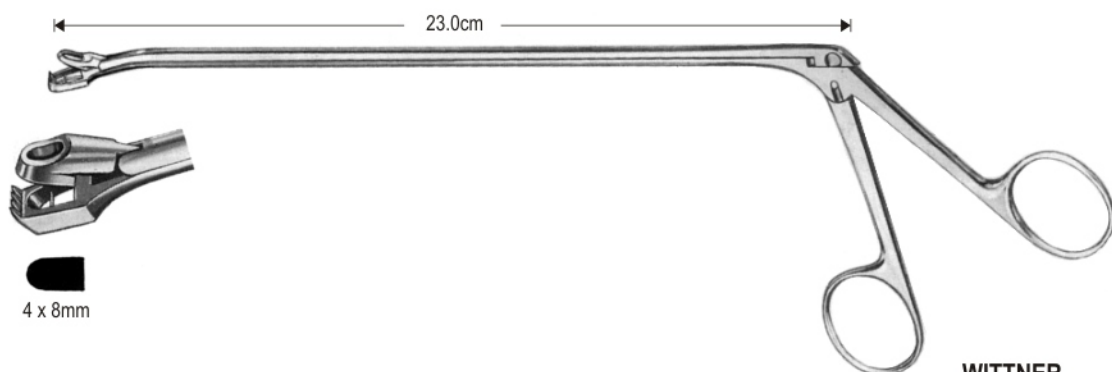

WITTNER

60.0782.23 23.0cm (straight)

60.0783.23 23.0cm (angled)

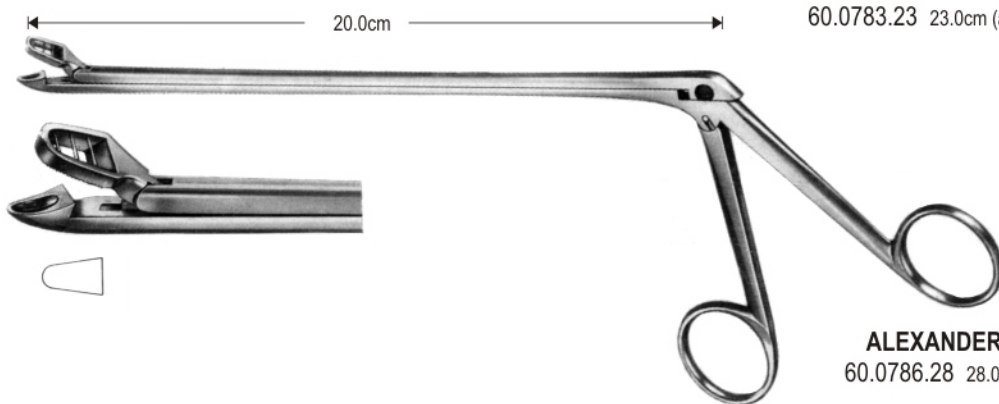

ALEXANDER

60.0786.28 28.0cm

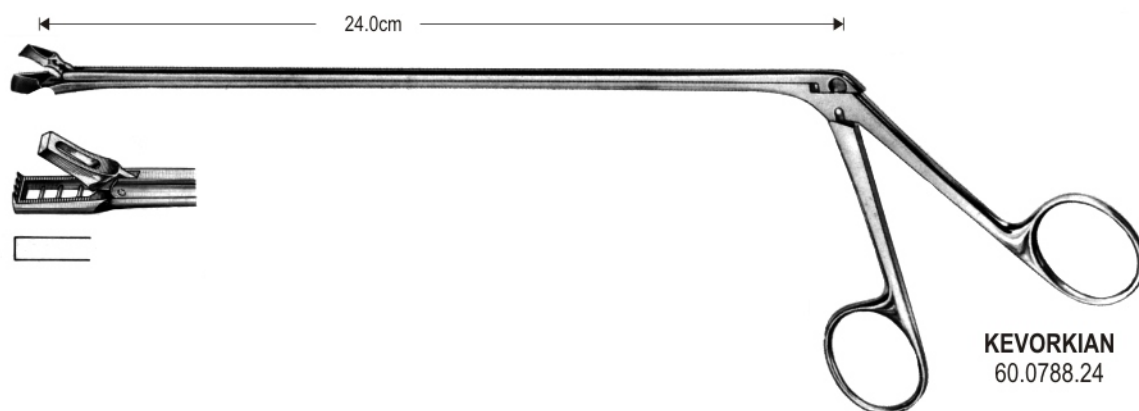

KEVORKIAN

60.0788.24

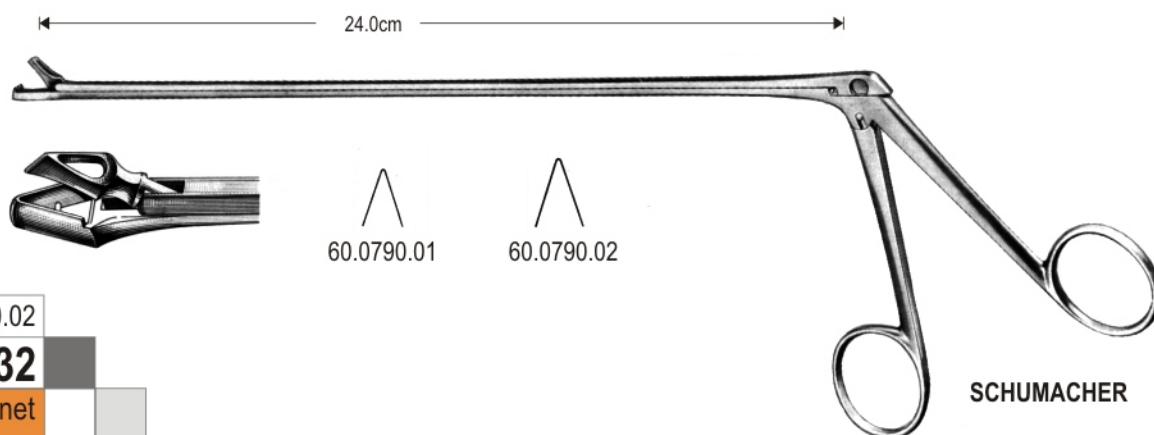

60.0790.01

60.0790.02

60.0790.02

60-032

www.hilbro.net

SCHUMACHER

Cervical Biopsy and Specimen Forceps EN

Probeexzisionszangen DE

Pinzas saca-bocados para biopsia ES

60

GYNECOLOGY

Hilbro



2.3 x 4.2 mm



TOWNSEND-MINI
60.0792.00

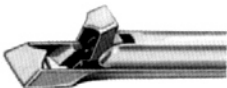

3 x 9.5 mm



TISCHLER-KEVORKIAN
60.0794.00



4 x 6.5 mm

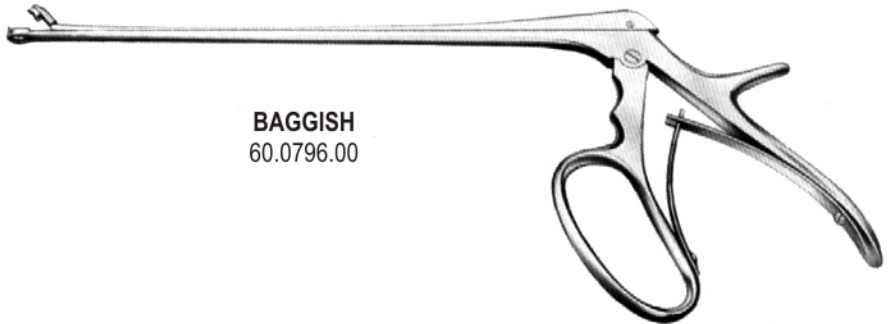

BAGGISH
60.0796.00



4 x 8 mm

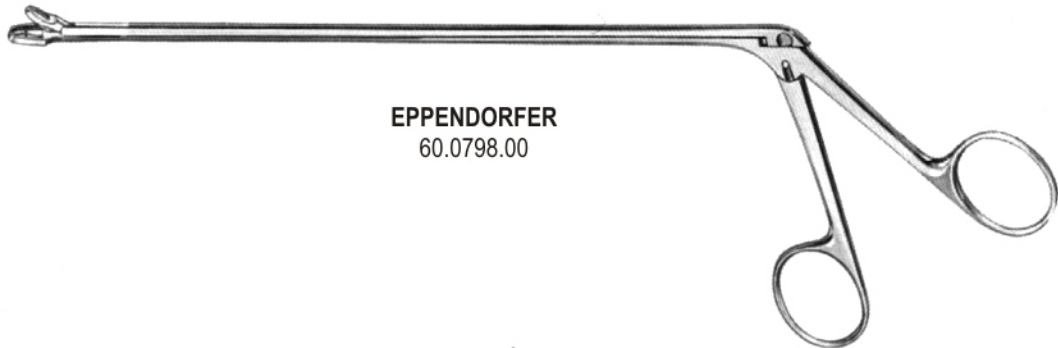

EPPENDORFER
60.0798.00

60.0798.00

60-033

www.hilbro.net

60

EN Cervical Biopsy and Specimen Forceps

DE Probeexzisionszangen

ES Pinzas saca-bocados para biopsia

Hilbro

GYNECOLOGY



oval
7 x 5 mm

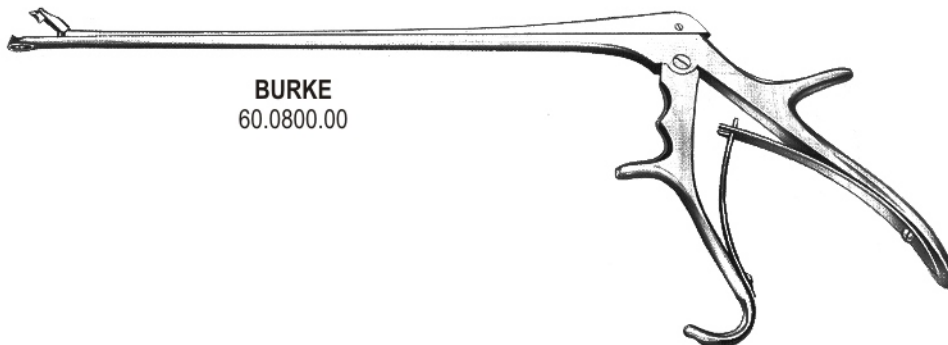

BURKE
60.0800.00

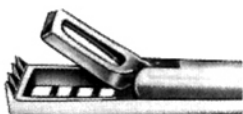

3 x 8 mm

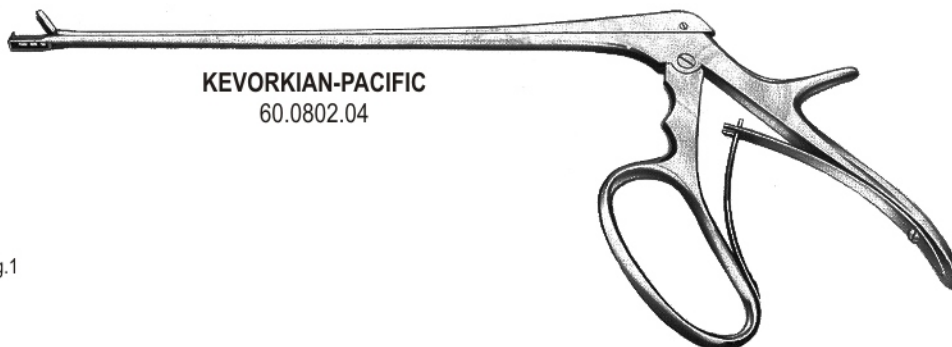

KEVORKIAN-PACIFIC
60.0802.04



Fig.1

TISCHLER-MORGAN



oval ● 3.7 x 5 mm

Fig.3

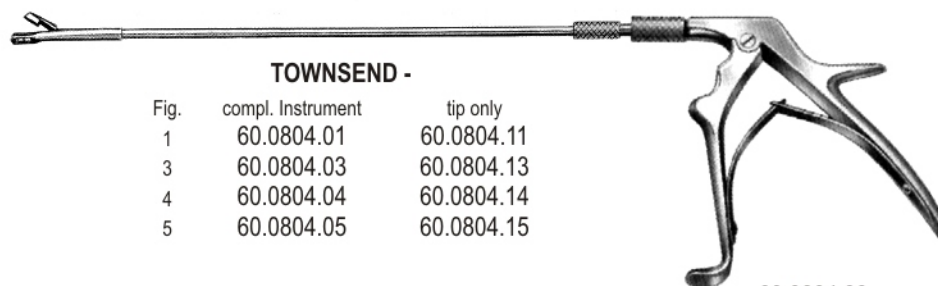

TOWNSEND -

| Fig. | compl. Instrument | tip only |
|------|-------------------|------------|
| 1 | 60.0804.01 | 60.0804.11 |
| 3 | 60.0804.03 | 60.0804.13 |
| 4 | 60.0804.04 | 60.0804.14 |
| 5 | 60.0804.05 | 60.0804.15 |

60.0804.99
handle only



Fig.4

KEVORKIAN



Fig.5

mini



SCHUMACHER
60.0806.00

Tip only



60.0806.01

60.0806.01

60-034

www.hilbro.net

Uterine Scoops EN

Uterusloffel DE

Cucharillas uterinas ES

60

GYNECOLOGY



60.0820.01



60.0824.01



60.0820.02



60.0824.02



60.0820.03



60.0824.03

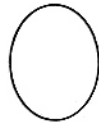

60.0820.04



60.0824.04



60.0820.05



60.0824.05

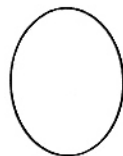

60.0820.06

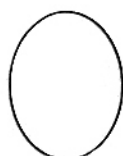

60.0824.06



SIMON
25.0cm, sharp, rigid



SCHROEDER
30.0cm, sharp, rigid



GOURDET
28.0cm, blunt



60.0830.01
6mm



60.0830.02
8mm



60.0830.03
10mm



60.0830.04
12mm



60.0830.05
14 mm

60.0830.05

60-035

www.hilbro.net

60

EN Uterine Curettes

DE Uteruskuretten

ES Curetas uterinas

Hilbro

GYNECOLOGY

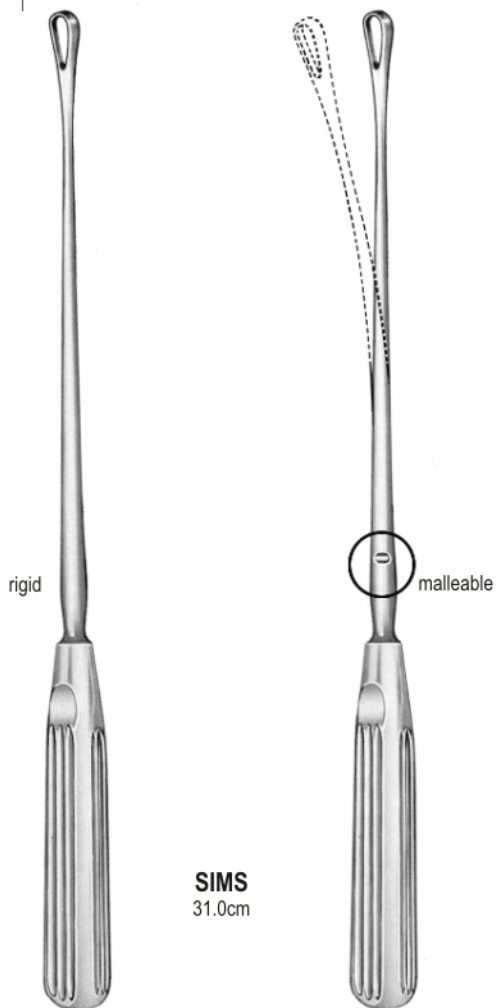

SIMS
31.0cm

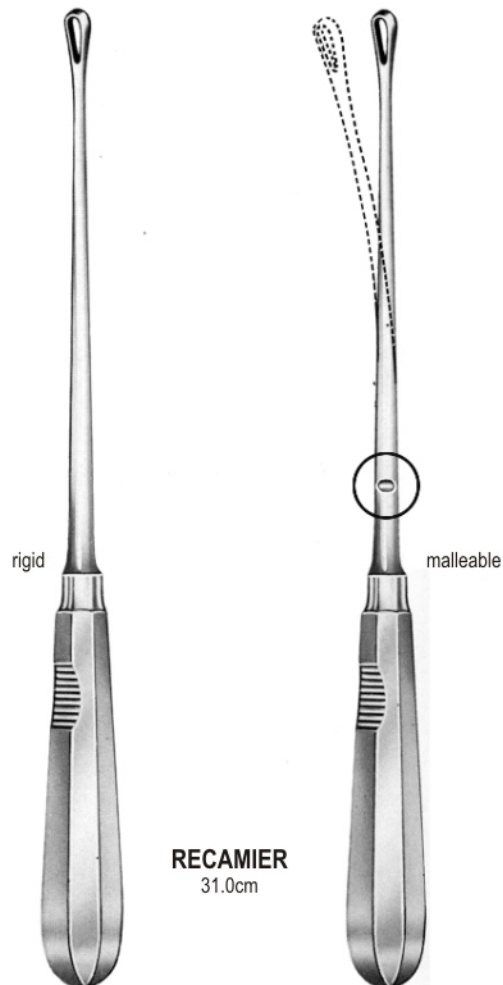

RECAMIER
31.0cm

| Fig | sharp | blunt | sharp | blunt |
|-----|------------|------------|------------|------------|
| 00 | 60.0840.05 | 60.0842.05 | 60.0844.05 | 60.0846.05 |
| 0 | 60.0840.06 | 60.0842.06 | 60.0844.06 | 60.0846.06 |
| 1 | 60.0840.07 | 60.0842.07 | 60.0844.07 | 60.0846.07 |
| 2 | 60.0840.08 | 60.0842.08 | 60.0844.08 | 60.0846.08 |
| 3 | 60.0840.09 | 60.0842.09 | 60.0844.09 | 60.0846.09 |
| 4 | 60.0840.11 | 60.0842.11 | 60.0844.11 | 60.0846.11 |
| 5 | 60.0840.12 | 60.0842.12 | 60.0844.12 | 60.0846.12 |
| 6 | 60.0840.14 | 60.0842.14 | 60.0844.14 | 60.0846.14 |
| 7 | 60.0840.15 | 60.0842.15 | 60.0844.15 | 60.0846.15 |
| 8 | 60.0840.16 | 60.0842.16 | 60.0844.16 | 60.0846.16 |
| 9 | 60.0840.19 | 60.0842.19 | 60.0844.19 | 60.0846.19 |
| 10 | 60.0840.20 | 60.0842.20 | 60.0844.20 | 60.0846.20 |
| 11 | 60.0840.21 | 60.0842.21 | 60.0844.21 | 60.0846.21 |
| 12 | 60.0840.23 | 60.0842.23 | 60.0844.23 | 60.0846.23 |
| 13 | 60.0840.25 | 60.0842.25 | 60.0844.25 | 60.0846.25 |
| 14 | 60.0840.30 | 60.0842.30 | 60.0844.30 | 60.0846.30 |
| 15 | 60.0840.35 | 60.0842.35 | 60.0844.35 | 60.0846.35 |
| 16 | 60.0840.40 | 60.0842.40 | 60.0844.40 | 60.0846.40 |

| Fig | sharp | blunt | sharp | blunt |
|-----|------------|------------|------------|------------|
| 00 | 60.0850.05 | 60.0852.05 | 60.0854.05 | 60.0856.05 |
| 0 | 60.0850.06 | 60.0852.06 | 60.0854.06 | 60.0856.06 |
| 1 | 60.0850.07 | 60.0852.07 | 60.0854.07 | 60.0856.07 |
| 2 | 60.0850.08 | 60.0852.08 | 60.0854.08 | 60.0856.08 |
| 3 | 60.0850.09 | 60.0852.09 | 60.0854.09 | 60.0856.09 |
| 4 | 60.0850.11 | 60.0852.11 | 60.0854.11 | 60.0856.11 |
| 5 | 60.0850.12 | 60.0852.12 | 60.0854.12 | 60.0856.12 |
| 6 | 60.0850.14 | 60.0852.14 | 60.0854.14 | 60.0856.14 |
| 7 | 60.0850.15 | 60.0852.15 | 60.0854.15 | 60.0856.15 |
| 8 | 60.0850.16 | 60.0852.16 | 60.0854.16 | 60.0856.16 |
| 9 | 60.0850.19 | 60.0852.19 | 60.0854.19 | 60.0856.19 |
| 10 | 60.0850.20 | 60.0852.20 | 60.0854.20 | 60.0856.20 |
| 11 | 60.0850.21 | 60.0852.21 | 60.0854.21 | 60.0856.21 |
| 12 | 60.0850.23 | 60.0852.23 | 60.0854.23 | 60.0856.23 |
| 13 | 60.0850.25 | 60.0852.25 | 60.0854.25 | 60.0856.25 |
| 14 | 60.0850.30 | 60.0852.30 | 60.0854.30 | 60.0856.30 |
| 15 | 60.0850.35 | 60.0852.35 | 60.0854.35 | 60.0856.35 |
| 16 | 60.0850.40 | 60.0852.40 | 60.0854.40 | 60.0856.40 |

60.0856.40

60-036

www.hilbro.net

Uterine Curettes EN

Uteruskuretten DE

Curetas uterinas ES

60

GYNECOLOGY

Hilbro

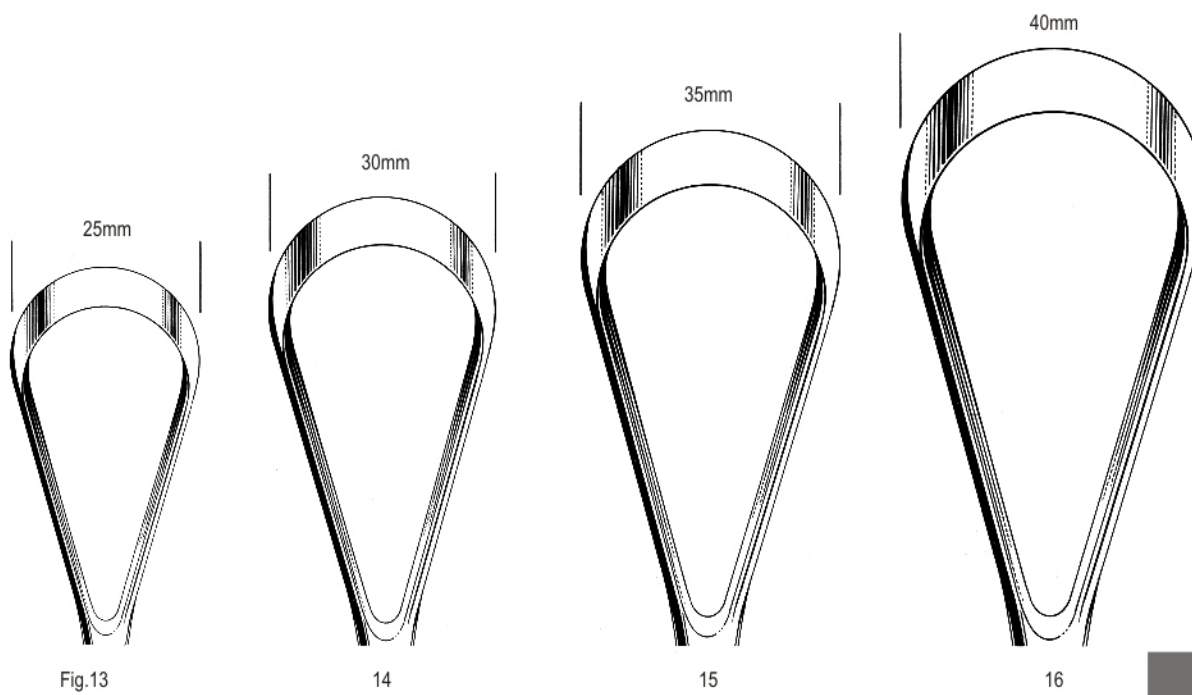
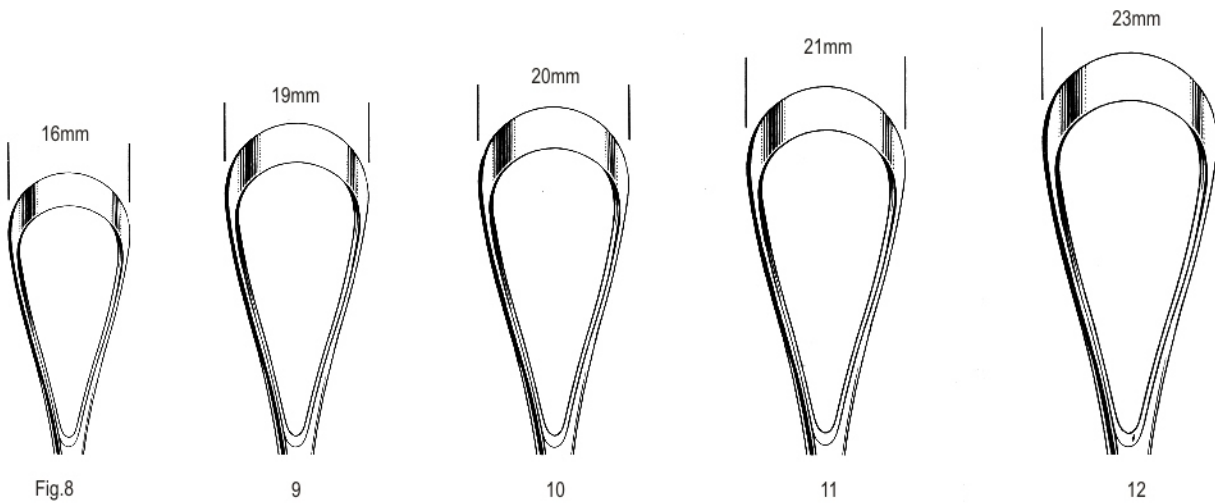
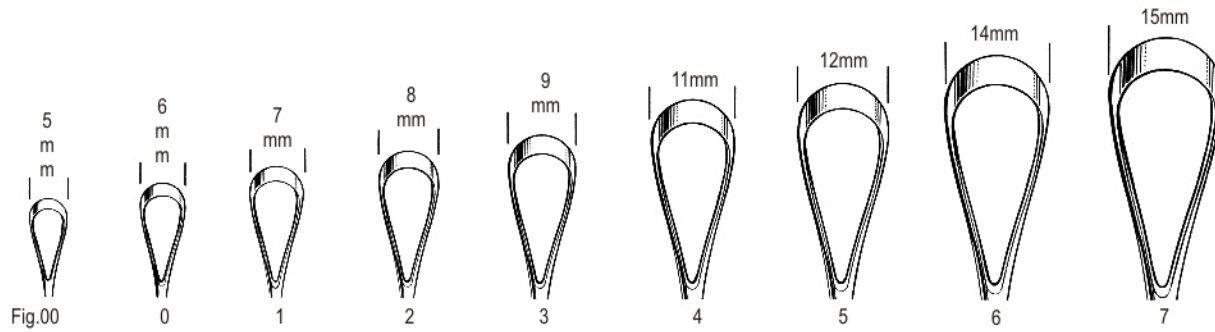

60.0856.40

60-037

www.hilbro.net

60

EN Uterine Curettes

DE Uteruskuretten

ES Curetas uterinas

Hilbro

GYNECOLOGY



BUMM
34.0cm

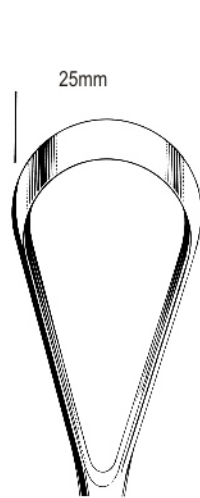
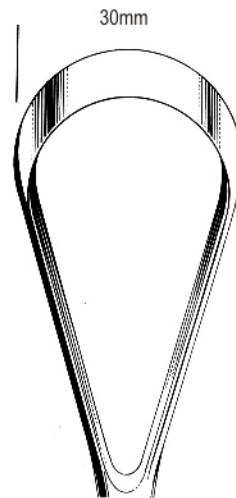
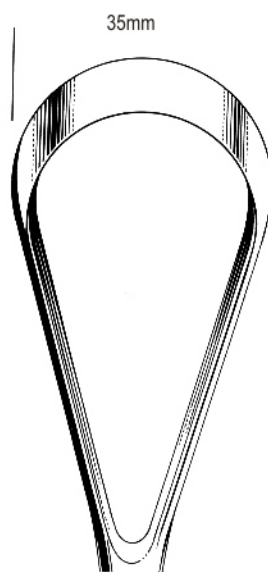

Fig. 13



14



15

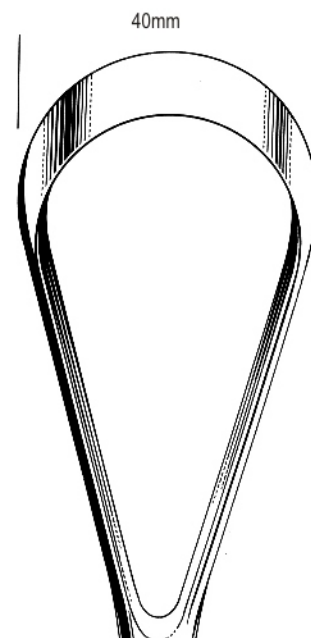

16

| Fig | sharp | blunt | sharp | blunt |
|-----|------------|------------|------------|------------|
| 13 | 60.0860.25 | 60.0862.25 | 60.0864.25 | 60.0866.25 |
| 14 | 60.0860.30 | 60.0862.30 | 60.0864.30 | 60.0866.30 |
| 15 | 60.0860.35 | 60.0862.35 | 60.0864.35 | 60.0866.35 |
| 16 | 60.0860.40 | 60.0862.40 | 60.0864.40 | 60.0866.40 |

60.0866.40

60-038

www.hilbro.net

Uterine Curettes EN

Uteruskuretten DE

Curetas uterinas ES

60

GYNECOLOGY

Hilbro

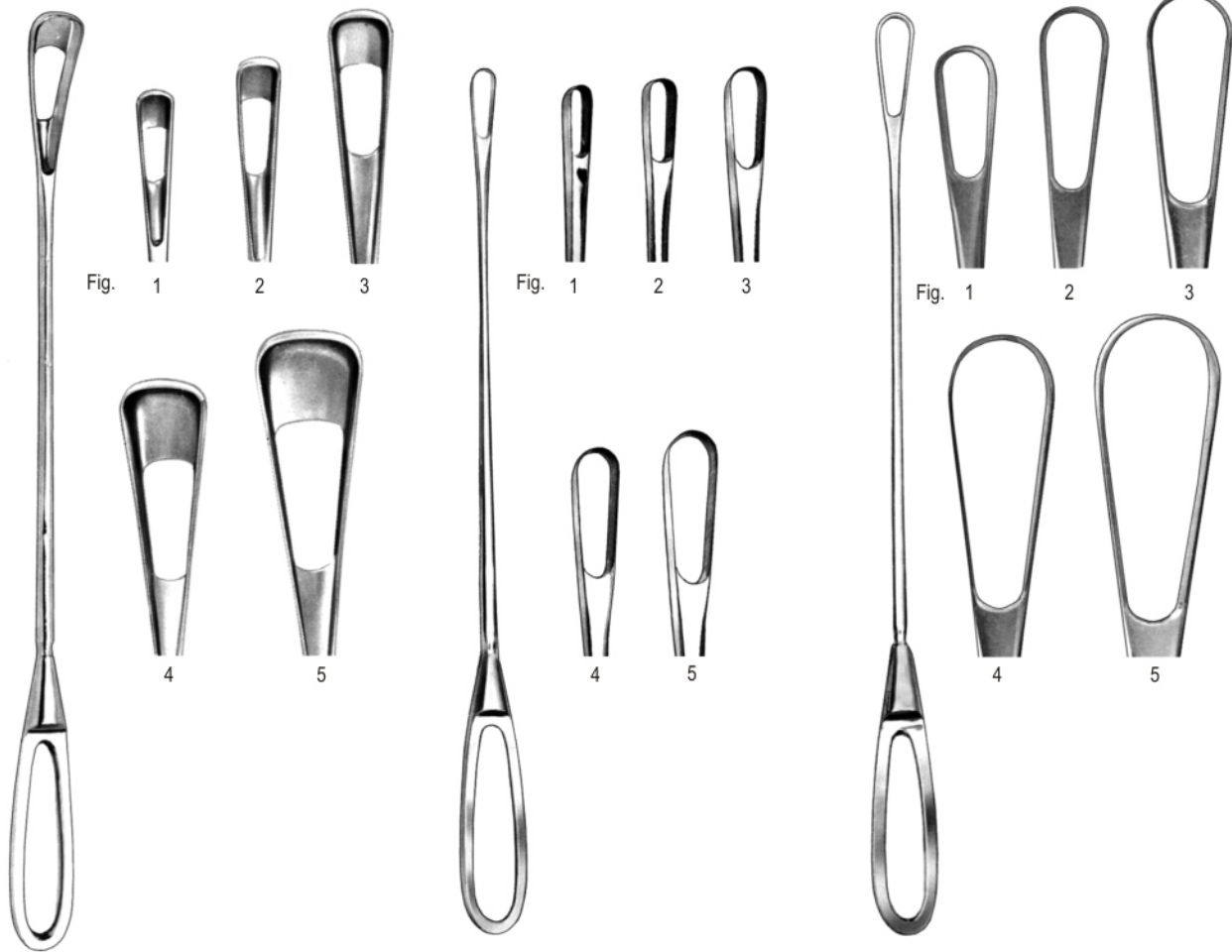

| Fig. | 28.0cm | mm |
|------|------------|-----|
| 1 | 60.0870.01 | 4.5 |
| 2 | 60.0870.02 | 6 |
| 3 | 60.0870.03 | 9 |
| 4 | 60.0870.04 | 12 |
| 5 | 60.0870.05 | 15 |

| Fig. | 27.0cm |
|------|------------|
| 1 | 60.0874.01 |
| 2 | 60.0874.02 |
| 3 | 60.0874.03 |
| 4 | 60.0874.04 |
| 5 | 60.0874.05 |

| Fig. | 28.0cm |
|------|------------|
| 1 | 60.0878.01 |
| 2 | 60.0878.02 |
| 3 | 60.0878.03 |
| 4 | 60.0878.04 |
| 5 | 60.0878.05 |

60.0878.05

60-039

www.hilbro.net

60

EN Uterine Curettes

DE Uteruskuretten

ES Curetas uterinas

Hilbro

GYNECOLOGY



Fig.

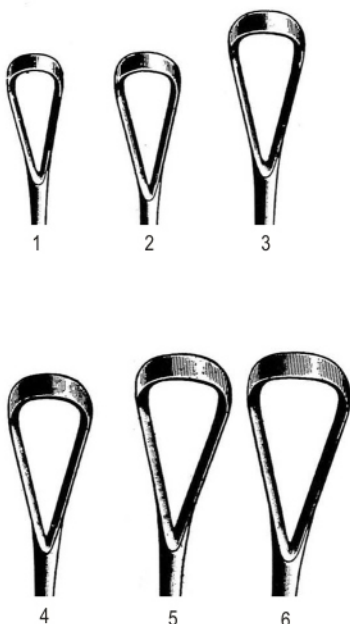

SIMS

25.0cm

| sharp | Fig | blunt |
|------------|-----|------------|
| 60.0880.01 | 1 | 60.0882.01 |
| 60.0880.02 | 2 | 60.0882.02 |
| 60.0880.03 | 3 | 60.0882.03 |
| 60.0880.04 | 4 | 60.0882.04 |
| 60.0880.05 | 5 | 60.0882.05 |
| 60.0880.06 | 6 | 60.0882.06 |



SIMS

25.0cm

| sharp | Fig | blunt |
|------------|-----|------------|
| 60.0884.01 | 1 | 60.0886.01 |
| 60.0884.02 | 2 | 60.0886.02 |
| 60.0884.03 | 3 | 60.0886.03 |

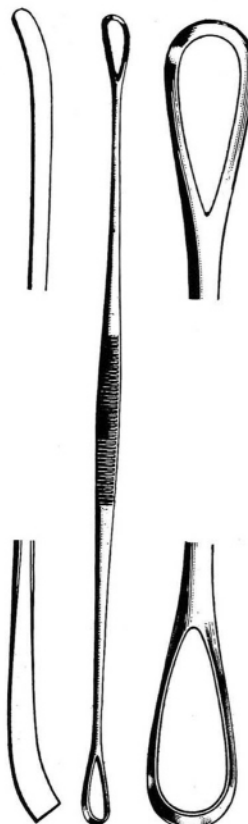

sharp / blunt
60.0890.27 27.0cm

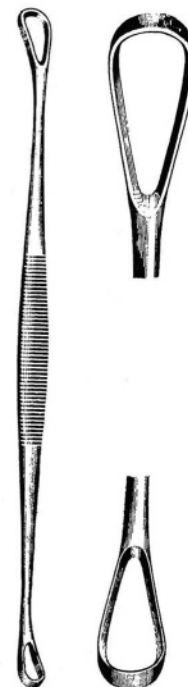

BLAKE
sharp / blunt
60.0894.27 27.0cm



SIMS
60.0900.25
25.0cm, sharp



SIMS
60.0902.25
25.0cm, sharp / blunt



60.0902.25

60-040

www.hilbro.net

Uterine Curettes EN

Uteruskuretten DE

Curetas uterinas ES

60

GYNECOLOGY



Fig.1

2

3

UNIVERSAL
28.0cm

RHEINSTADTER
29.0cm

CHELSEA HOSPITAL
60.0916.31 31.0cm

DONALD
sharp
60.0920.33 33.0cm

Fig

- 1 60.0906.01
- 2 60.0906.02
- 3 60.0906.03

- | | | | |
|------------|---------|------------|-------|
| | sharp | | blunt |
| 60.0910.01 | 7.9 mm | 60.0912.01 | |
| 60.0910.02 | 11.1 mm | 60.0912.02 | |
| 60.0910.03 | 14.3mm | 60.0912.03 | |

60.0920.33

60-041

www.hilbro.net

60

EN Suction Biopsy Curettes

DE Saug und Biopsiekuretten

ES Curetts aspiradores para biopsia

Hilbro

GYNECOLOGY



RANDALL

24.0cm

- 60.0924.01 1mm dia.
- 60.0924.02 2mm dia.
- 60.0924.03 3mm dia.
- 60.0924.04 4mm dia.



NOVAK

23.0cm

- 60.0930.01
- 60.0930.02
- 60.0930.03
- 60.0930.04



SHERMAN

60.0934.23 23.0cm
3.5mm dia.

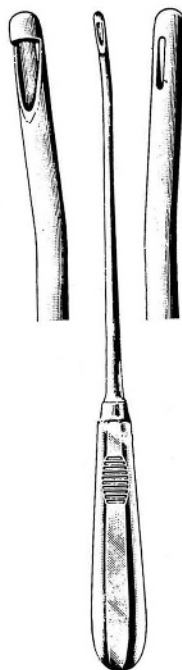

MUENCHEN

60.0940.27 27.0cm

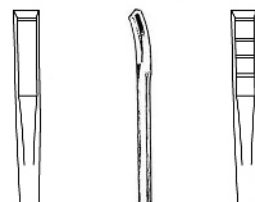

with basket



KEVORKIAN

30.0cm

- 60.0944.12 1.2mm
- 60.0944.40 4.0mm
- 60.0946.12
- 60.0946.40

60.0946.40

60-042

www.hilbro.net