



# INTESTINAL & STOMACH

# 52



PAGE 001 to 019



- EN Intestinal and Stomach
- DE Darm und Magen
- ES Intestinal y el estómago

SERVING HEALTHCARE WORLDWIDE



## INTESTINAL & STOMACH



**ALLIS-BABY**  
52.0010.12 12.0cm  
4:5 teeth



**ALLIS**  
4:5 teeth 5:6 teeth  
52.0020.15 15.0cm 52.0022.15  
52.0020.19 19.0cm 52.0022.19  
52.0020.22 22.0cm 52.0022.22  
52.0020.25 25.0cm 52.0022.25



**BOYS-ALLIS**  
52.0030.15 15.0cm

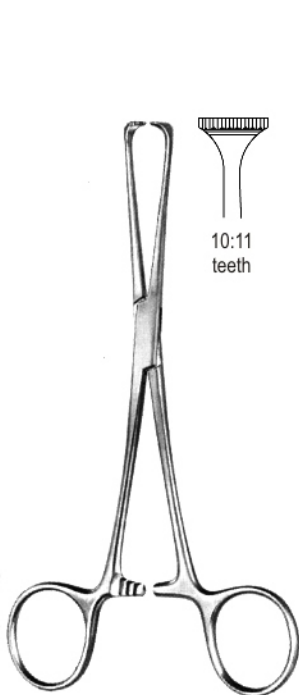

**ALLIS-ADAIR**  
52.0040.15 15.5cm



**JUDD-ALLIS**  
52.0050.15 15.0cm  
52.0050.19 19.0cm

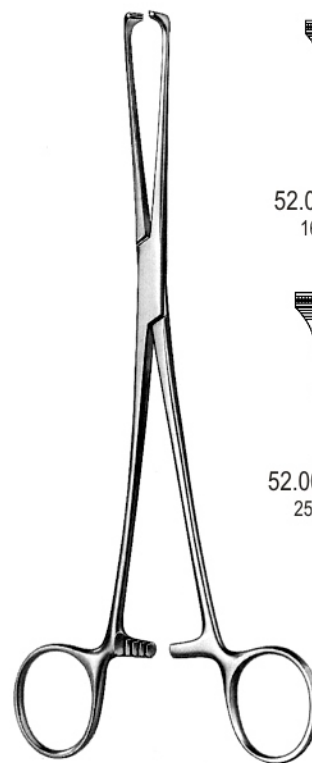

**ALLIS-ATRAUMA**

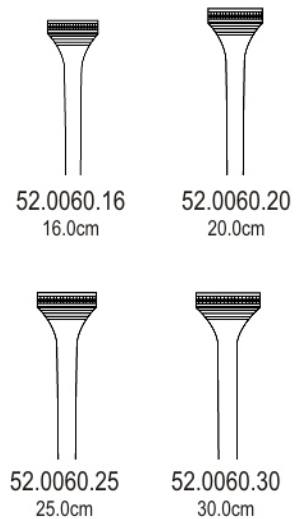

52.0060.16  
16.0cm

52.0060.20  
20.0cm

52.0060.25  
25.0cm

52.0060.30  
30.0cm

52.0060.30

**52-001**

[www.hilbro.net](http://www.hilbro.net)

EN Tissue and Intestinal Forceps

DE Gewebe und Darmklemmen

ES Pinzas para tejido e intestinales

**Hilbro**

## INTESTINAL & STOMACH



**THOMS-ALLIS**  
52.0070.20 20.0cm



**ALLIS**  
52.0080.20 20.0cm

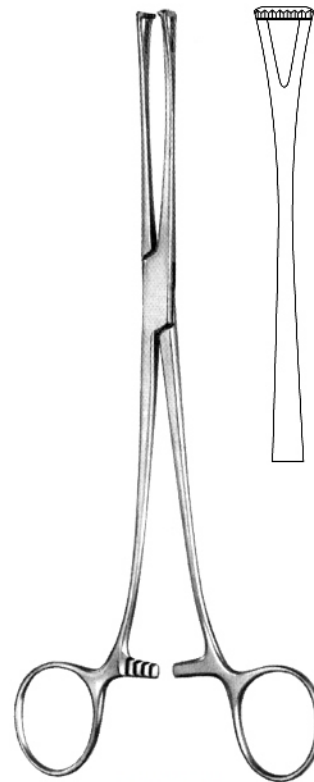

**LOCKWOOD**  
52.0090.20 20.0cm

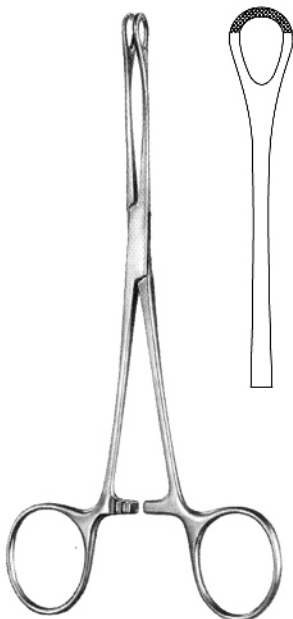

**WILLIAMS**  
52.0100.16 16.0cm

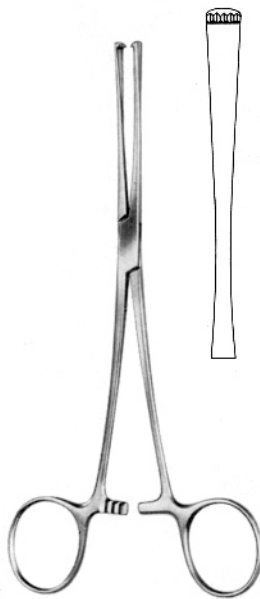

**LOCKWOOD-ALLIS**  
52.0110.16 16.0cm  
52.0110.20 20.0cm

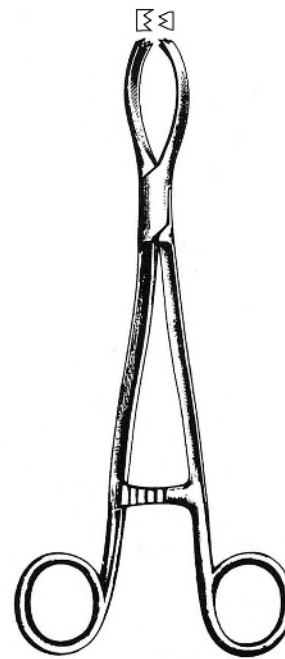

**LITTLEWOOD**  
52.0120.19 19.0cm

52.0120.19

**52-002**

www.hilbro.net

INTESTINAL & STOMACH

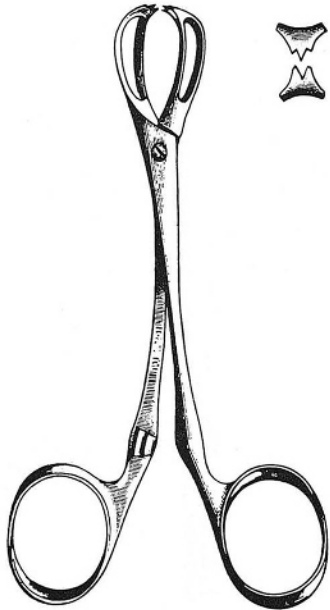

LANE

- 52.0130.12 12.5cm
- 52.0130.15 15.0cm
- 52.0130.19 19.0cm



LANE

- 52.0134.12 12.5cm
- 52.0134.15 15.0cm
- 52.0134.19 19.0cm

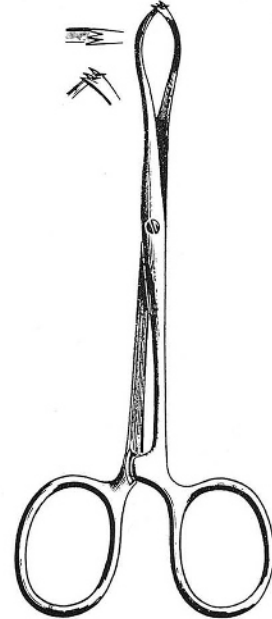

PORRIER

- 52.0140.12 12.5cm
- 52.0140.18 18.0cm

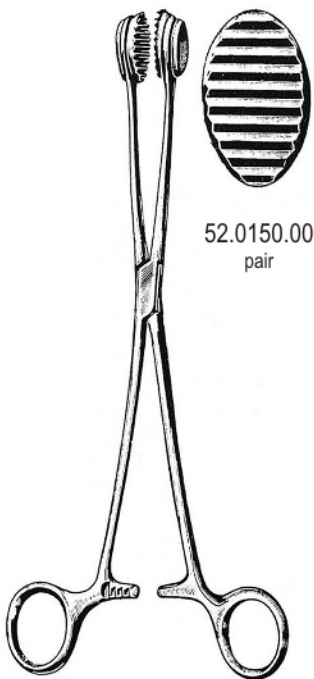

CHILDS

- 52.0150.24 24.0cm

52.0150.00 pair

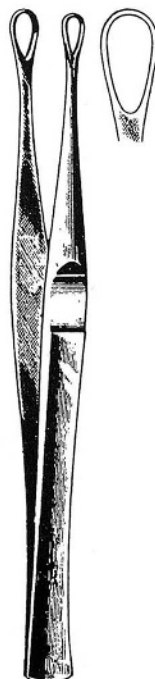

DENIS-BROWNE

- 52.0160.18 18.0cm

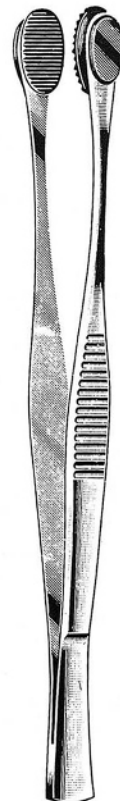

YOUNG

- 52.0170.21 21.0cm

52.0170.21

52-003

www.hilbro.net

EN Intestinal Forceps

DE Darmklemmen

ES Pinzas intestinales

**Hilbro**

## INTESTINAL & STOMACH



**BABCOCK**

52.0180.16 16.0cm  
 52.0180.18 18.0cm  
 52.0180.20 20.0cm  
 52.0180.24 24.0cm



**BABCOCK**

52.0182.16 16.0cm  
 52.0182.18 18.0cm  
 52.0182.20 20.0cm  
 52.0182.24 24.0cm

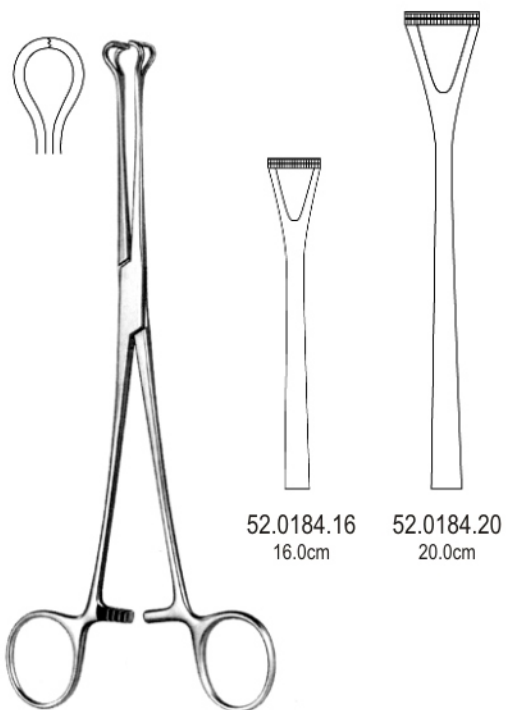

**BABCOCK-ATRAUMA**

52.0184.16 16.0cm  
 52.0184.20 20.0cm

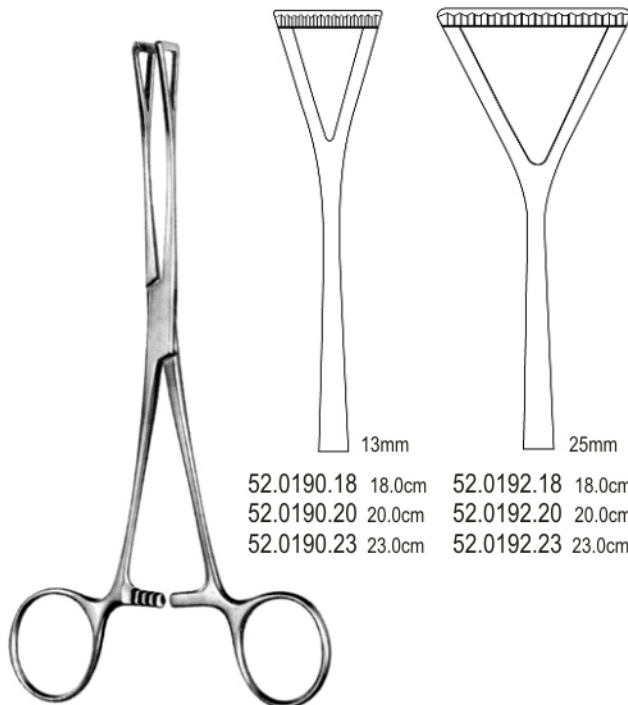

**DUVAL**

52.0190.18 18.0cm  
 52.0190.20 20.0cm  
 52.0190.23 23.0cm  
 52.0192.18 18.0cm  
 52.0192.20 20.0cm  
 52.0192.23 23.0cm

52.0192.23

**52-004**

www.hilbro.net

Intestinal Clamp Forceps EN

Darmklemmen DE

Pinzas-clamps intestinales ES

52

INTESTINAL & STOMACH

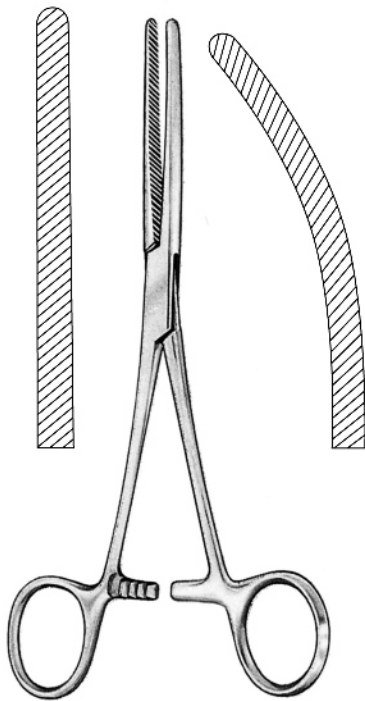

**BABY-DOYEN**

52.0200.18 18.0cm 52.0201.18

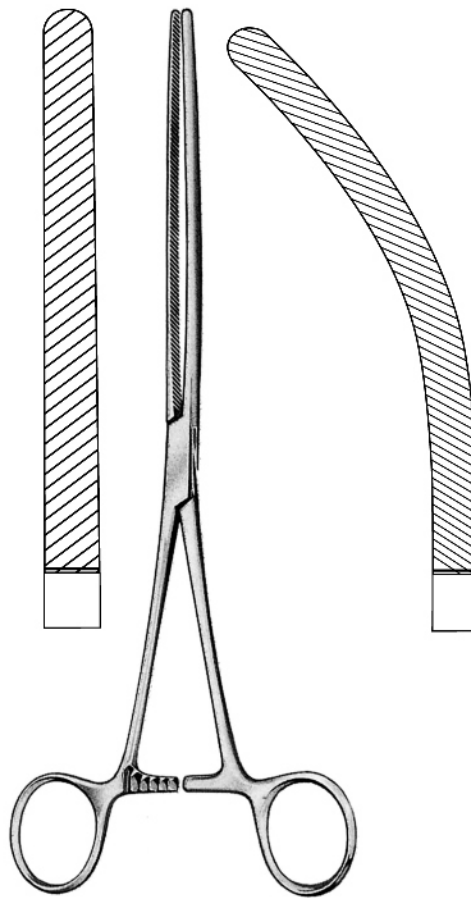

**DOYEN**

52.0204.21 21.0cm 52.0205.21  
52.0204.23 23.0cm 52.0205.23

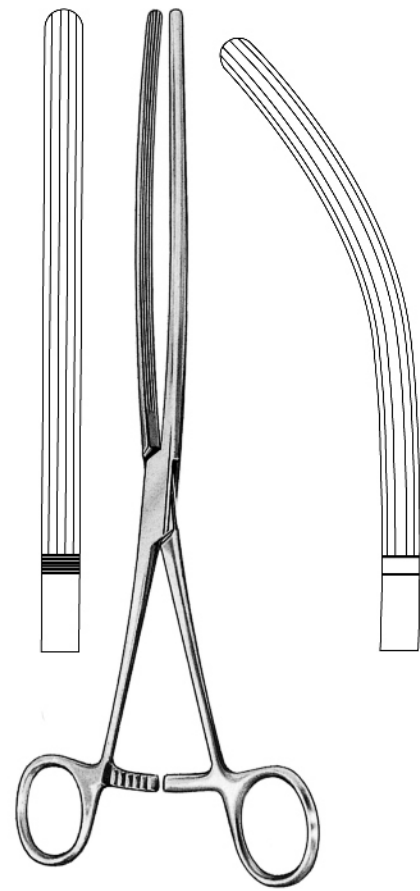

**MAYO-ROBSON**

52.0210.21 21.0cm 52.0211.21  
52.0210.23 23.0cm 52.0211.23  
52.0210.25 25.0cm 52.0211.25

52.0211.25

**52-005**

[www.hilbro.net](http://www.hilbro.net)

## INTESTINAL & STOMACH

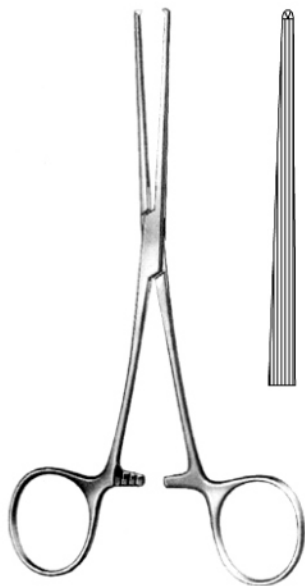

**ALLEN**  
 52.0220.15 15.5cm



**KLEINSCHMIDT**  
 52.0230.12 12.0cm

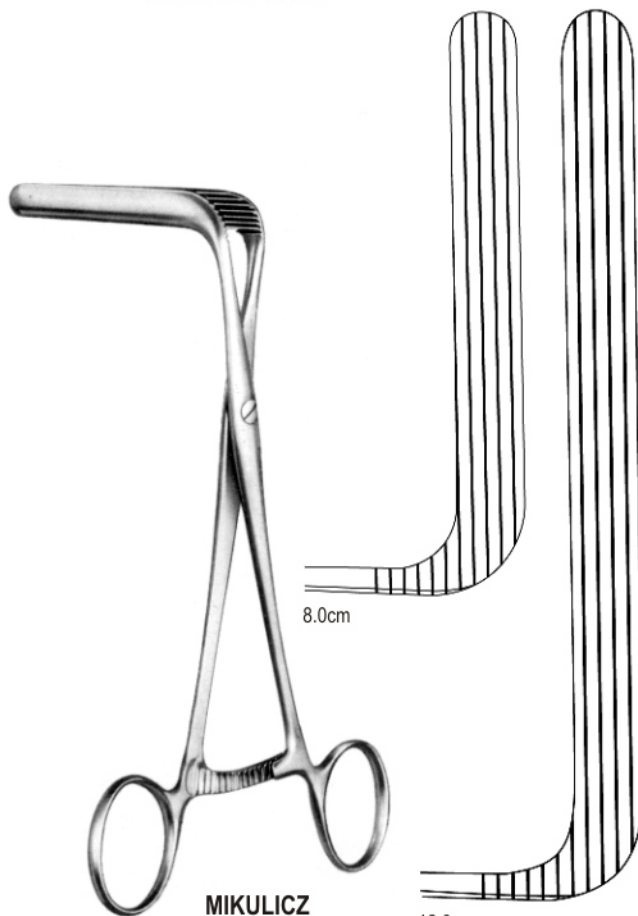

**MIKULICZ**  
 52.0240.08 8.0cm  
 52.0240.12 12.0cm

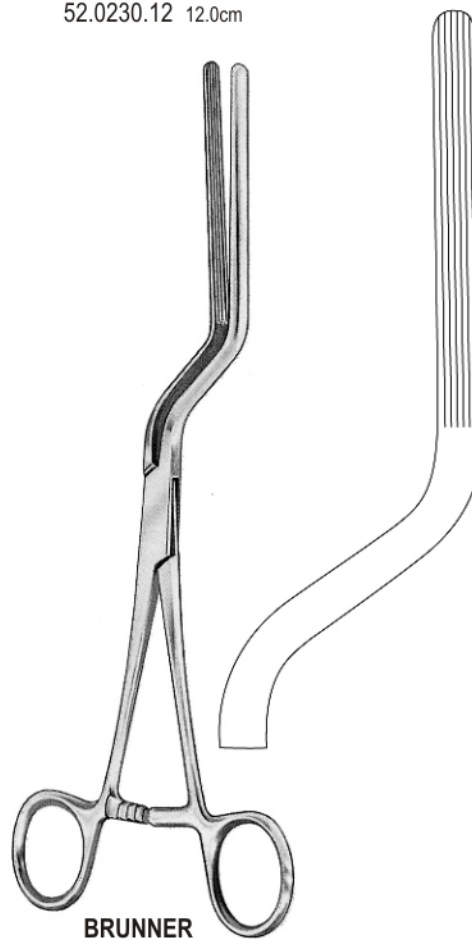

**BRUNNER**  
 52.0250.24 24.0cm

52.0250.24

**52-006**

www.hilbro.net

Intestinal Clamp Forceps EN

Darmklemmen DE

Pinzas-clamps intestinales ES

52

INTESTINAL & STOMACH



**SCUDDER**

52.0260.25 25.0cm 52.0261.25  
52.0260.33 33.0cm 52.0261.33

**MOYNIHAN**

52.0270.36 36.0cm 52.0271.36

**MOYNIHAN**

52.0280.29 29.0cm 52.0281.29

52.0281.29

**52-007**

www.hilbro.net



# 52

EN Intestinal Clamp Forceps

DE Darmklemmen

ES Pinzas-clamps intestinales

**Hilbro**

## INTESTINAL & STOMACH

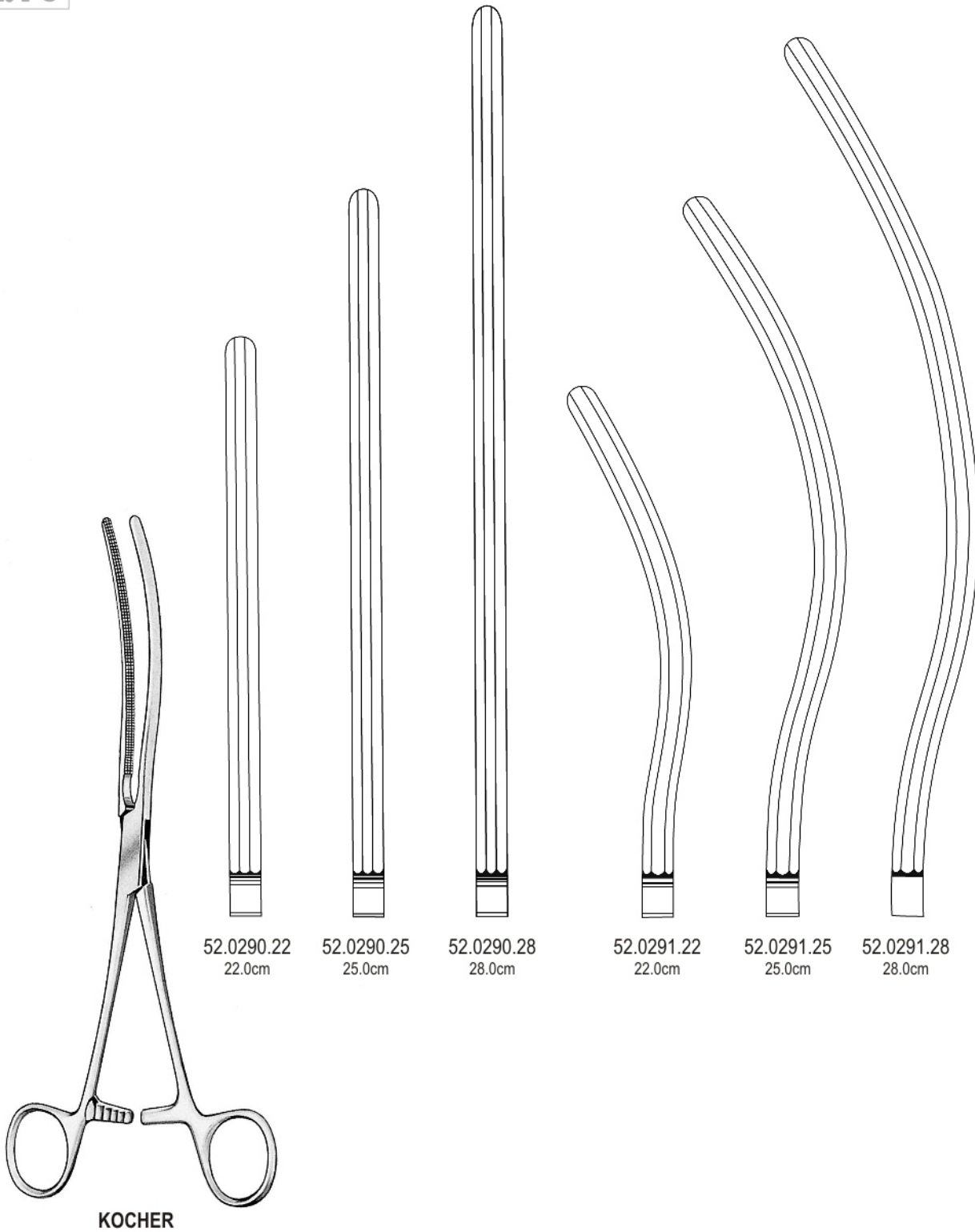

52.0291.28

**52-008**

[www.hilbro.net](http://www.hilbro.net)

**ATRAUMA**

**INTESTINAL & STOMACH**



**DOYEN-ATRAUMA**

52.0300.16  
16.0cm

52.0300.18  
18.0cm

52.0300.21  
21.0cm

52.0300.23  
23.0cm

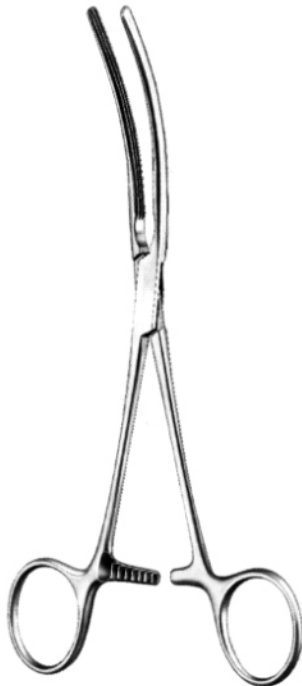

**DOYEN-ATRAUMA**

52.0301.16  
16.0cm

52.0301.18  
18.0cm

52.0301.21  
21.0cm

52.0301.23  
23.0cm

52.0301.23

**52-009**

[www.hilbro.net](http://www.hilbro.net)



KOCHER-ATRAUMA

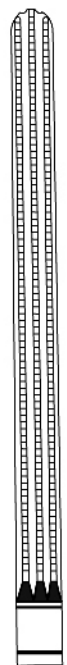

52.0310.22  
22.0cm

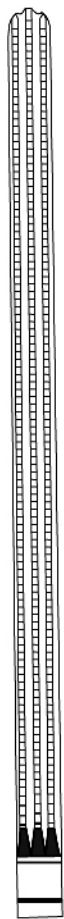

52.0310.25  
25.0cm

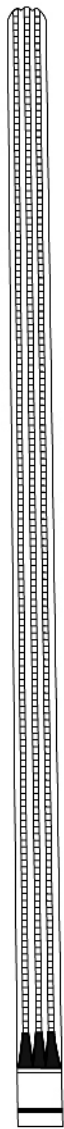

52.0310.28  
28.0cm

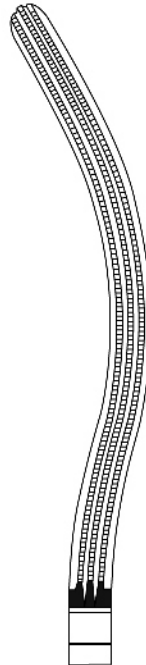

52.0311.22  
22.0cm

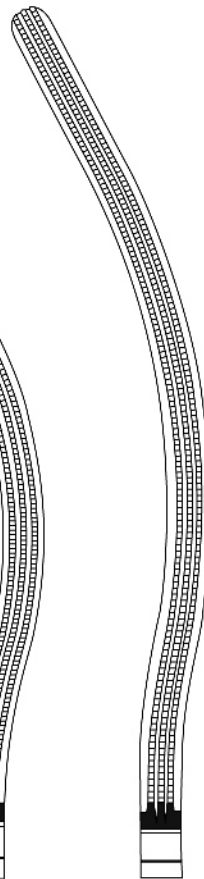

52.0311.25  
25.0cm

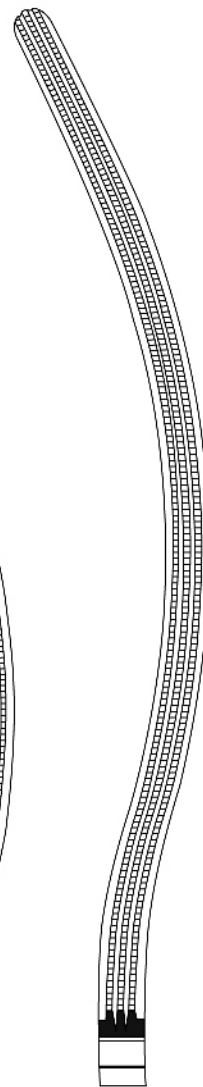

52.0311.28  
28.0cm

52.0311.28

**52-010**

[www.hilbro.net](http://www.hilbro.net)

ATRAUMA

INTESTINAL & STOMACH

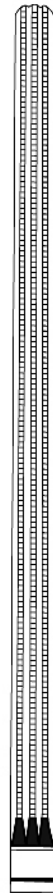

MAYO-ROBSON-ATRAUMA  
52.0320.25 25.0cm

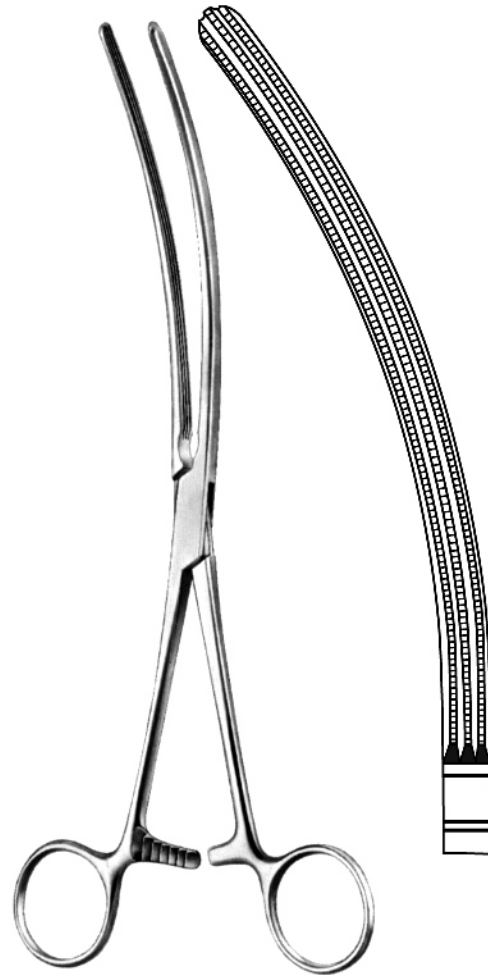

MAYO-ROBSON-ATRAUMA  
52.0321.25 25.0cm

52.0321.25

52-011

www.hilbro.net

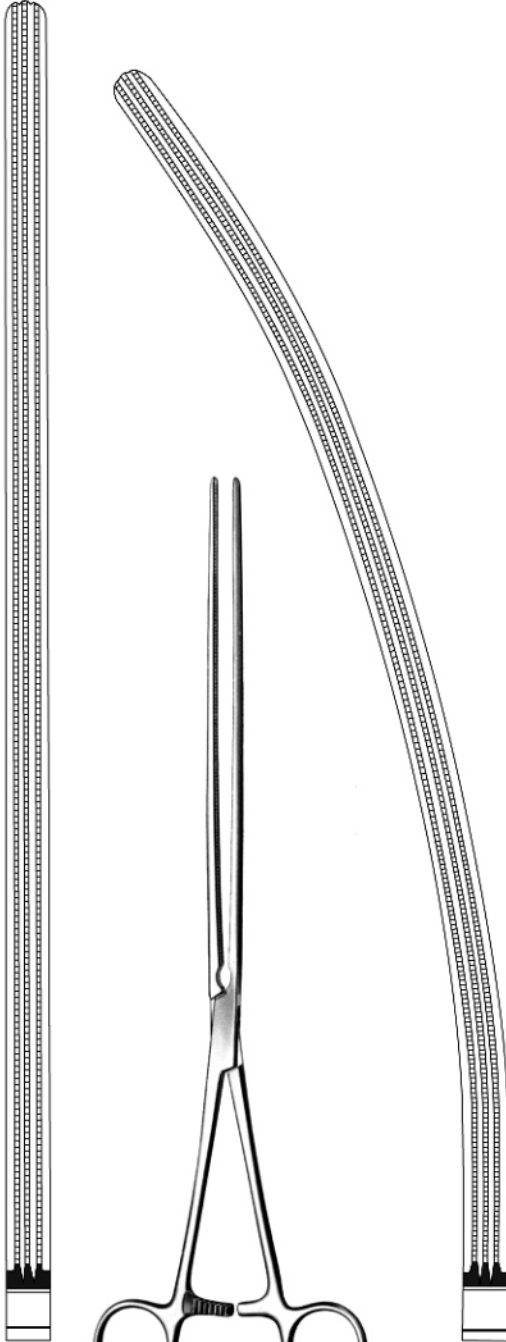

**SCUDDER**  
52.0330.33 33.0cm 52.0331.33

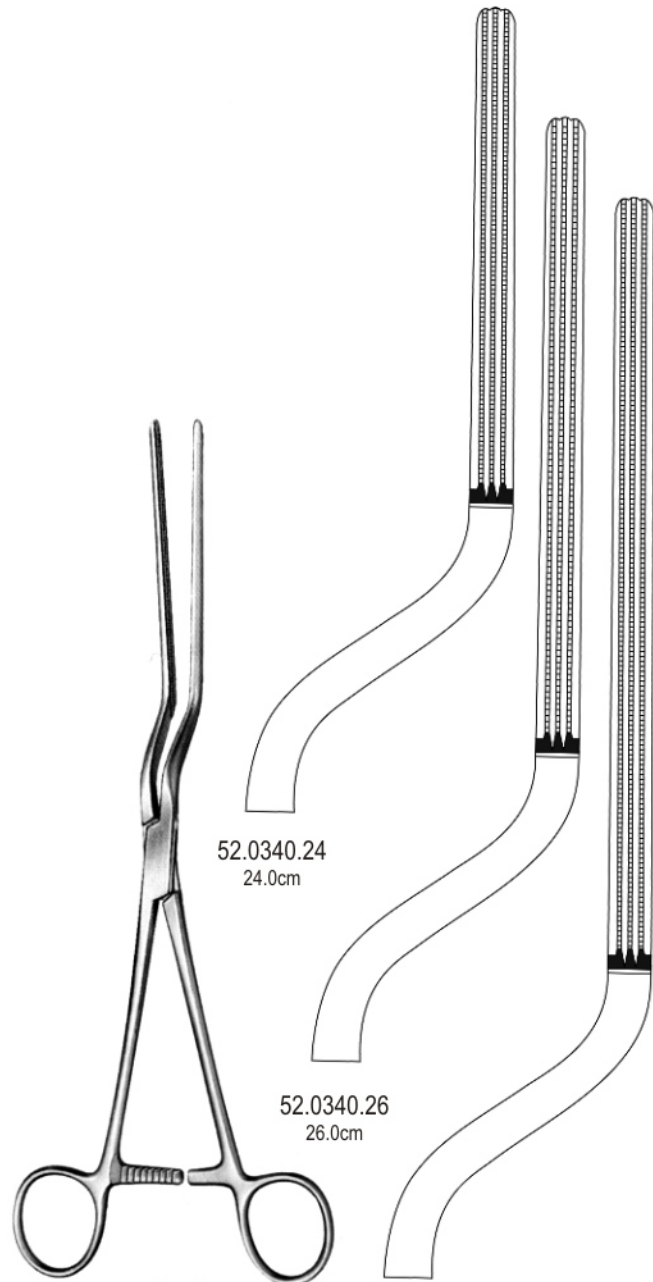

52.0340.24  
24.0cm

52.0340.26  
26.0cm

52.0340.28  
28.0cm

52.0340.28

**52-012**

[www.hilbro.net](http://www.hilbro.net)

ATRAUMA

INTESTINAL & STOMACH

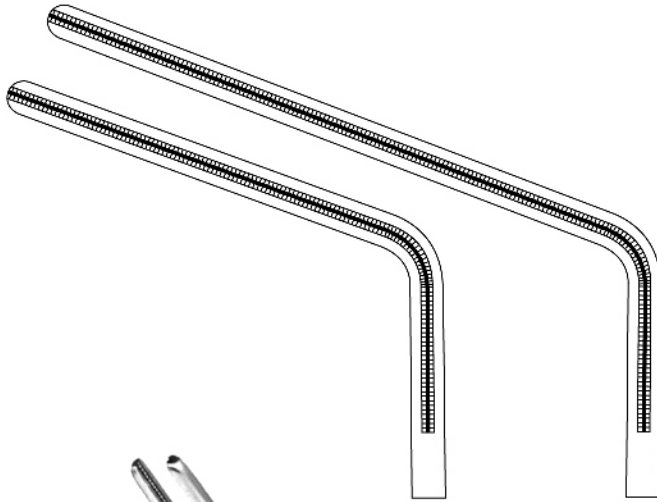

52.0350.26 26.0cm 52.0350.28 28.0cm

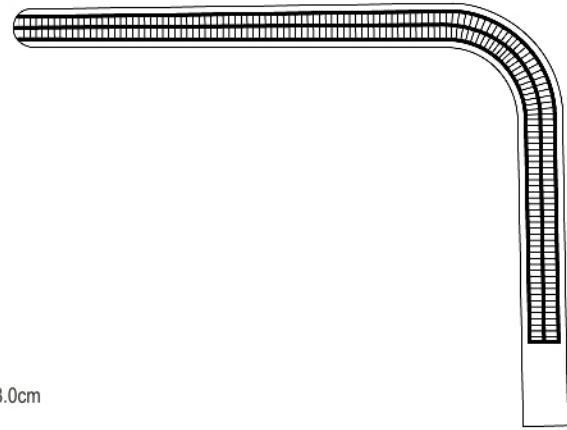

HAYES

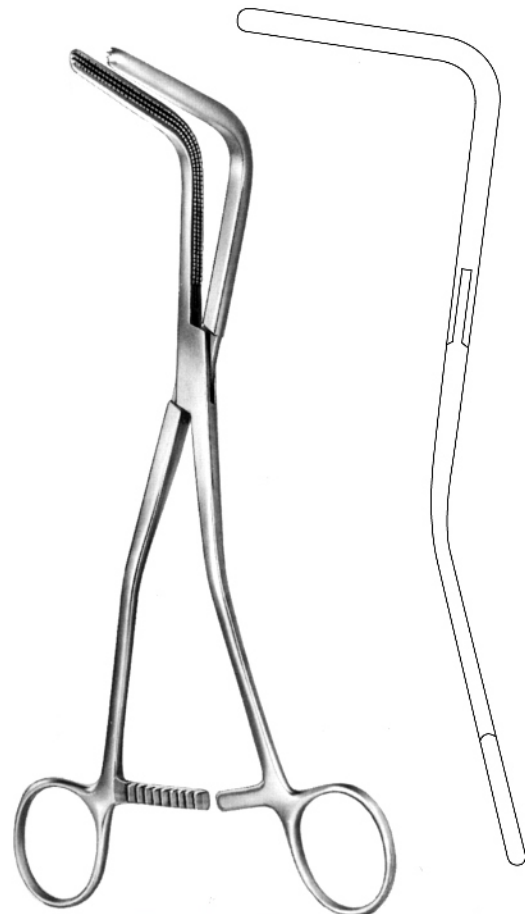

VEIDENHEIMER  
52.0360.23 23.0cm

52.0360.23

52-013

www.hilbro.net

52

- EN Atrauma Sigmoid Anastomosis Forceps
- DE Atrauma Rektum-Anastomosenklemmen
- ES Atrauma pinzas para anastomosis del recto

Hilbro

INTESTINAL & STOMACH

ATRAUMA

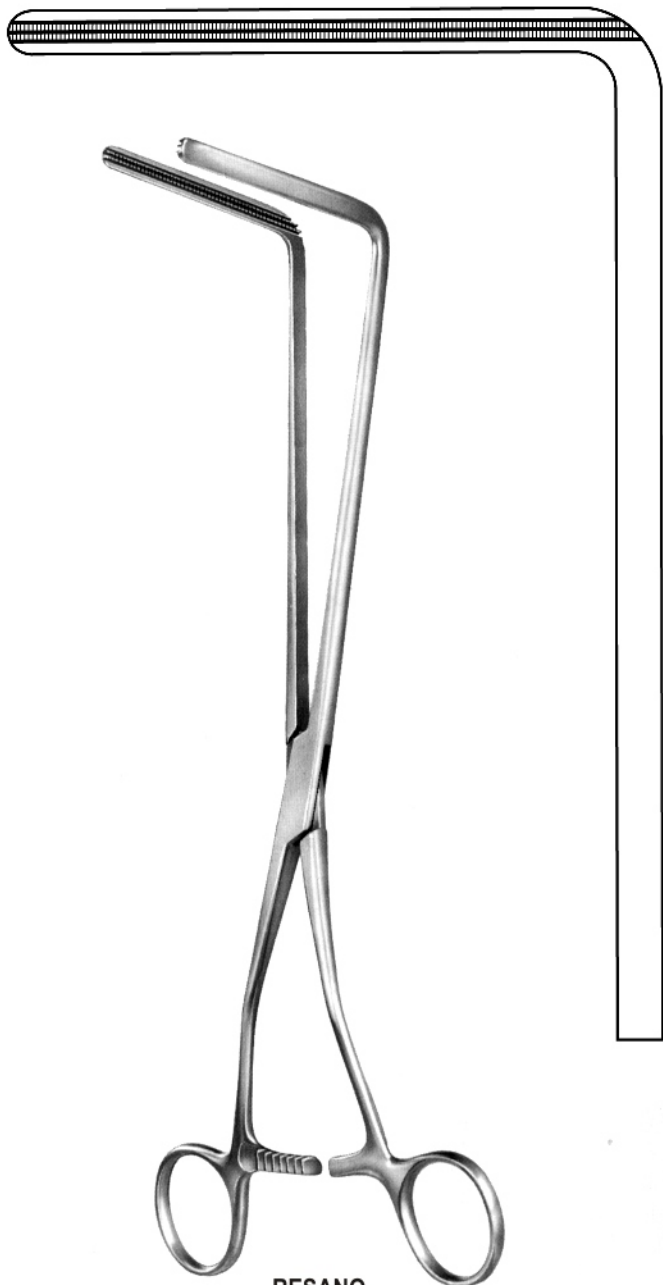

**RESANO**  
52.0364.30 30.0cm



**FEHLAND**  
52.0370.24 24.0cm

52.0370.24

**52-014**

www.hilbro.net

Intestinal and Stomach Clamps EN

Darm-und Magenklappen DE

Pinzas-clamps intestinales y estomacales ES

52

INTESTINAL & STOMACH

Hilbro

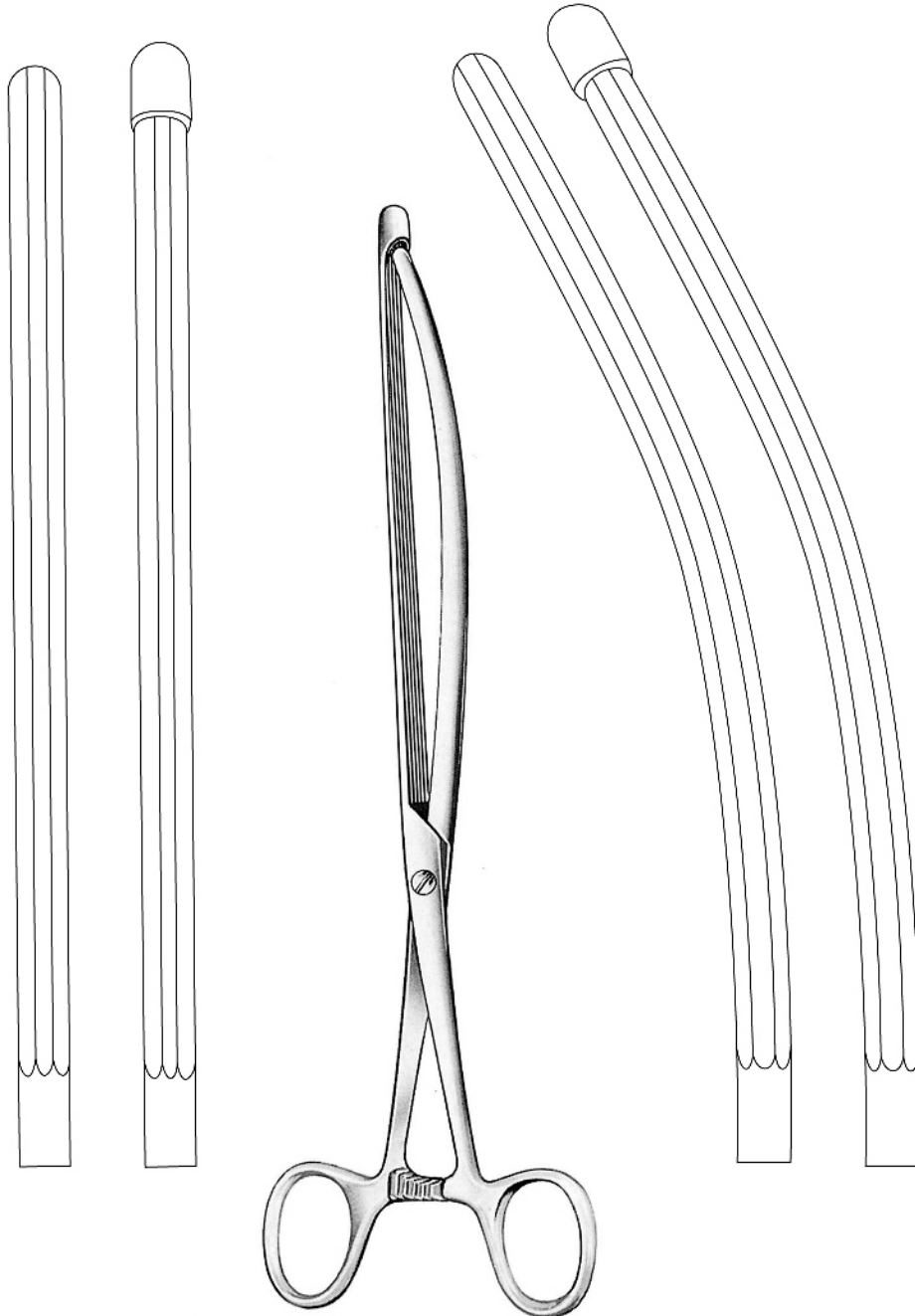

**NUSSBAUM**

52.0380.25 25.0cm 52.0381.25  
52.0380.30 30.0cm 52.0381.30

52.0381.30

**52-015**

[www.hilbro.net](http://www.hilbro.net)



52

EN Intestinal and Stomach Clamps

DE Darm-und Magenklappen

ES Pinzas-clamps intestinales y estomacales

Hilbro

INTESTINAL & STOMACH

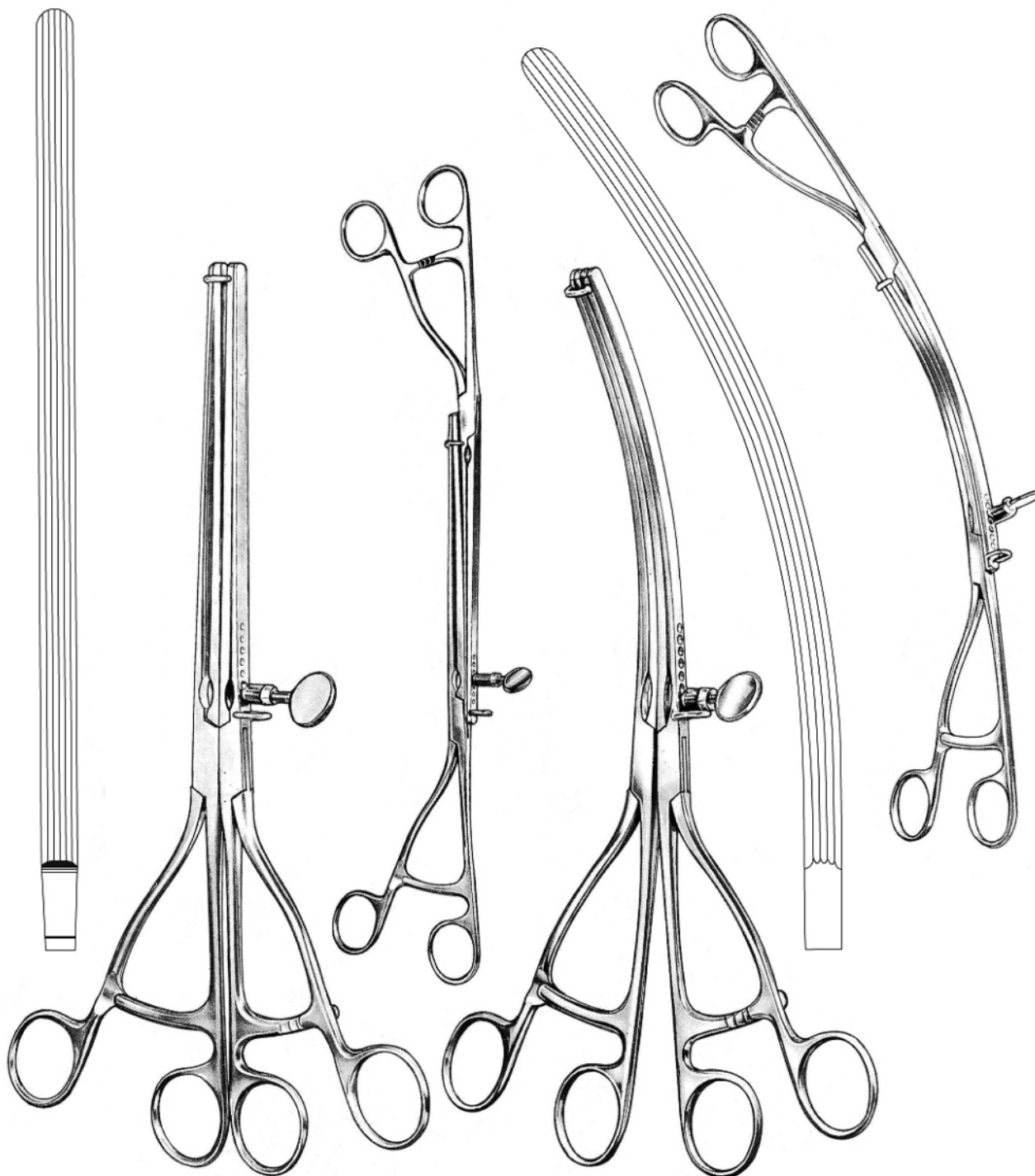

LANE  
52.0390.30 30.0cm

LANE  
52.0391.30 30.0cm

52.0391.30

52-016

www.hilbro.net

Intestinal and Stomach Clamps EN

Darm-und Magenklappen DE

Pinzas-clamps intestinales y estomacales ES

52

INTESTINAL & STOMACH

Hilbro



**ROOSEVELT**  
52.0400.34 34.0cm

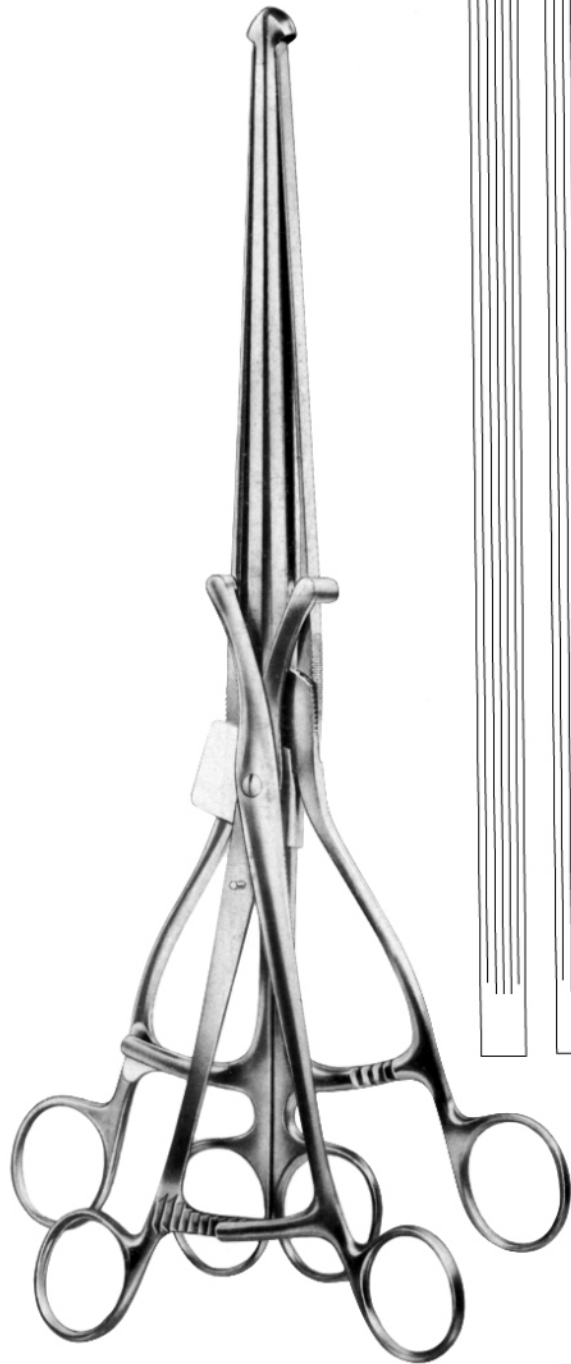

**HABERER**  
52.0410.36 36.0cm

52.0410.36

**52-017**

[www.hilbro.net](http://www.hilbro.net)

# 52

EN Intestinal and Stomach Clamps

DE Darm-und Magenklappen

ES Pinzas-clamps intestinales y estomacales

**Hilbro**

## INTESTINAL & STOMACH



**PAYR-BABY**  
52.0420.15 15.0cm



**PAYR**  
52.0420.21 21.0cm



**PAYR**  
52.0420.29 29.0cm



**PAYR**  
52.0420.35 35.0cm

52.0420.35

**52-018**

[www.hilbro.net](http://www.hilbro.net)

INTESTINAL & STOMACH

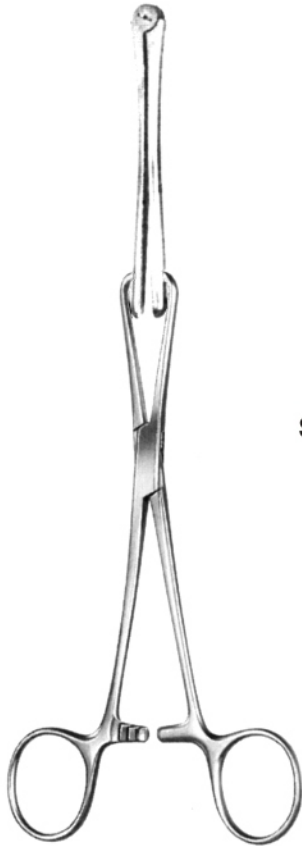

**STONE-WATT**  
52.0432.00

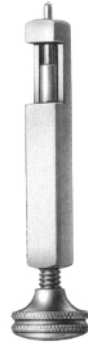

52.0434.08 8.5cm



**STONE-WATT**  
52.0436.07 7.5cm  
52.0436.10 10.0cm

**STONE**  
52.0430.15 15.5cm

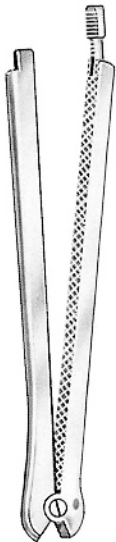

**DE MARTEL-WOLFSON**  
52.0440.05 5.0cm  
52.0440.07 7.0cm  
52.0440.10 10.0cm



**DE MARTEL-WOLFSON**  
52.0444.23 23.0cm

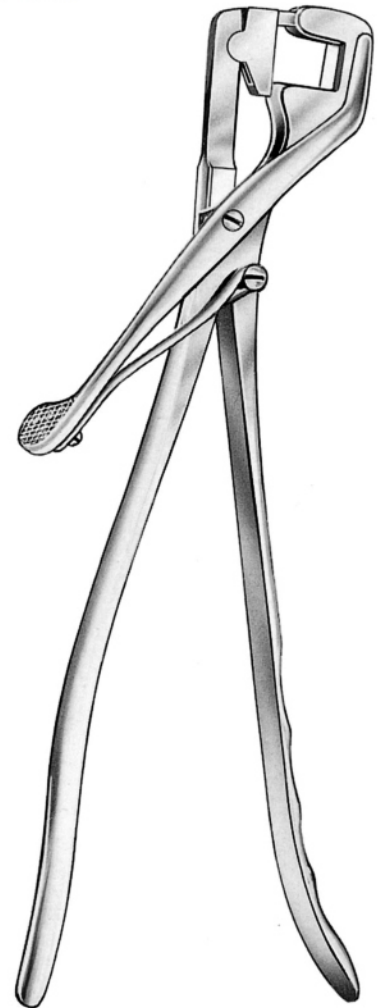

**DE MARTEL-WOLFSON**  
52.0450.26 26.0cm

52.0450.26

**52-019**

www.hilbro.net