



ORAL INSTRUMENTS

48



PAGE 001 to 011



- EN Oral Instruments
- DE Mündliche Instrumente
- ES Instrumentos orales

SERVING HEALTHCARE WORLDWIDE

www.hilbro.net



Napkin Holders, Oral Wedges, Finger Protectors EN

Serviettenhalter, Mundkeile, Fingerschutz DE

Porta-servilletas, garrotes, dedales ES

48

ORAL

Hilbro

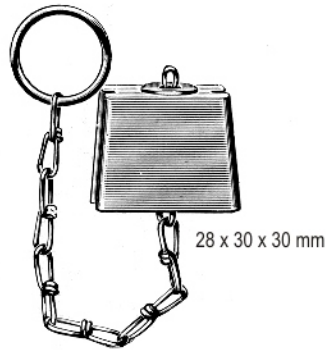

PITHA
48.0010.02

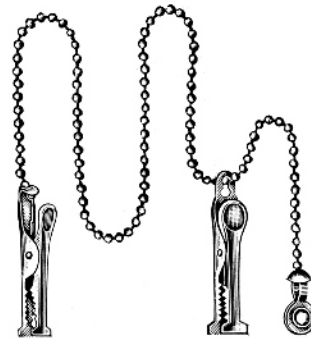

48.0012.00
length adjustable



ADAMS
48.0014.00

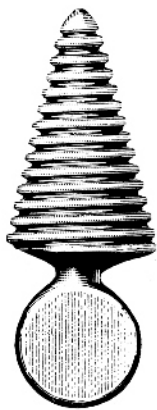

MAUNDER
48.0020.10



48.0030.11

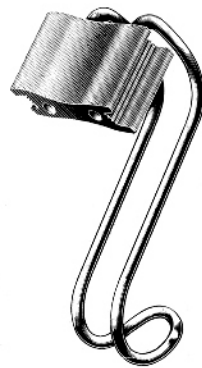

PITHA
48.0036.10



48.0040.01



LANGENBECK
48.0040.02

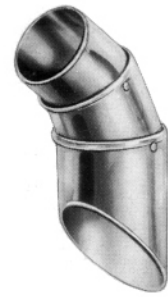

48.0040.03

48.0040.03

48-001

www.hilbro.net

EN Mouth Gags

DE Mundsperrer

ES Abre-bocas

Hilbro

ORAL

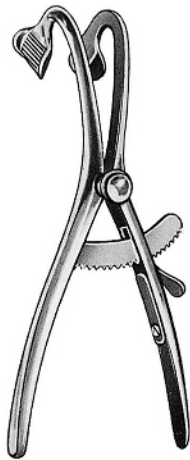

DENHART
48.0050.12 12.0cm



DENHART
48.0054.12 12.5cm

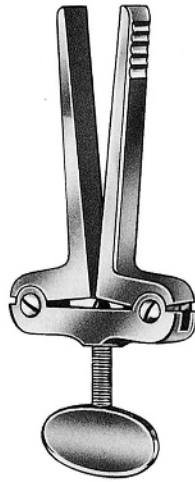

HEISTER
48.0060.13 13.0cm

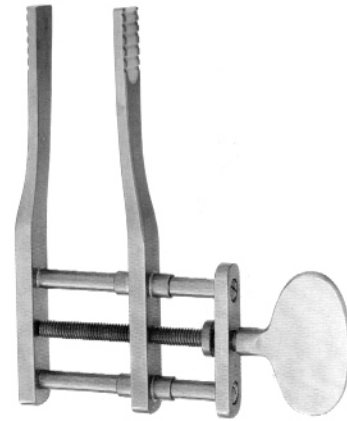

OBWEGESER
48.0064.12 12.5cm

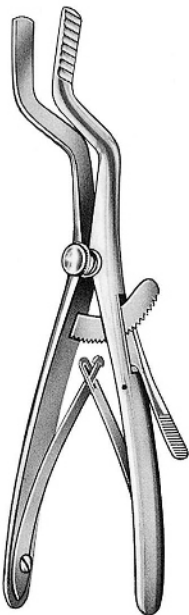

ROSER-KÖNIG
48.0070.16 16.0cm
48.0070.19 19.0cm

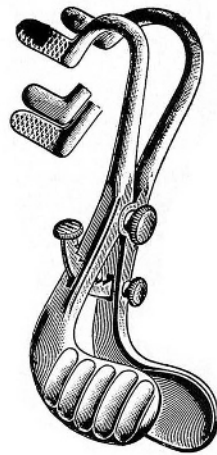

BUXTON
ackland jaws 48.0080.01
parallel jaws 48.0080.02



FERGUSSON
ackland jaws 48.0090.16 16.0cm
parallel jaws 48.0092.16
48.0090.19 19.0cm 48.0092.19

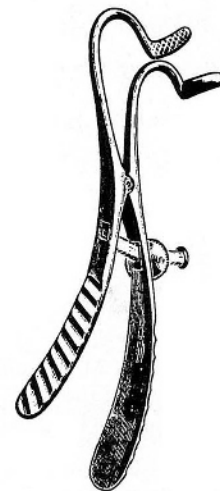

MASON
ackland jaws 48.0100.15 15.0cm
parallel jaws 48.0102.15
48.0100.19 19.0cm 48.0102.19

48.0102.19

48-002

www.hilbro.net

Mouth Gags EN

Mundsperrer DE

Abre-bocas ES

48

ORAL

Hilbro

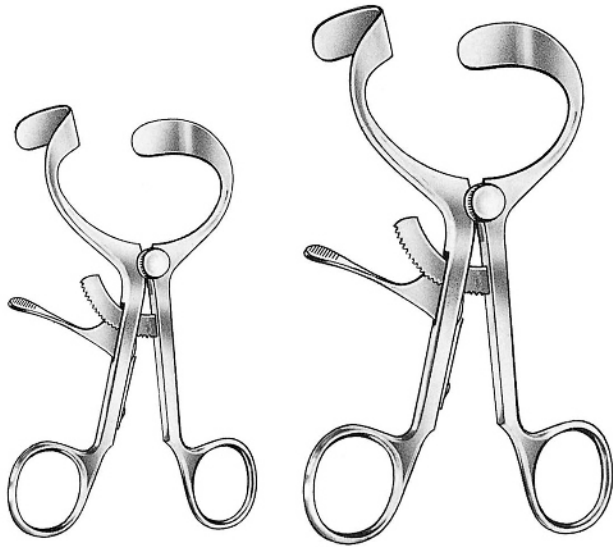

MOLT
48.0110.11 11.0cm

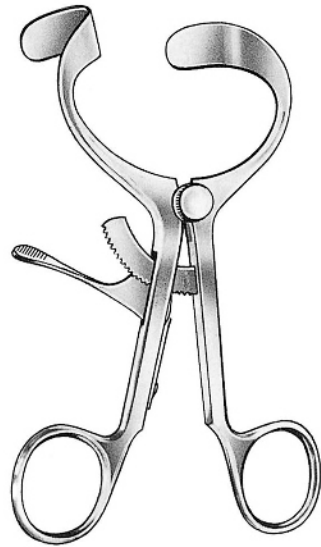

MOLT
48.0112.14 14.0cm



MALEK
13.0cm



- 48.0120.00 compl. set
- 48.0120.13 frame only
- 48.0120.01 blade, fig.1, 15-19 x 36mm
- 48.0120.02 blade, fig.2, 17-21 x 44mm
- 48.0120.03 blade, fig.3, 19-23 x 59 mm
- 48.0120.04 blade, fig.4, 25-31 x 78 mm



KILNER-DOUGHTY
48.0124.00 compl. set
48.0124.10 frame only



48.0124.01



48.0124.02



48.0124.03



48.0124.04

48.0124.04

48-003

www.hilbro.net

EN Mouth Gags

DE Mundsperrer

ES Abre-bocas

Hilbro

ORAL

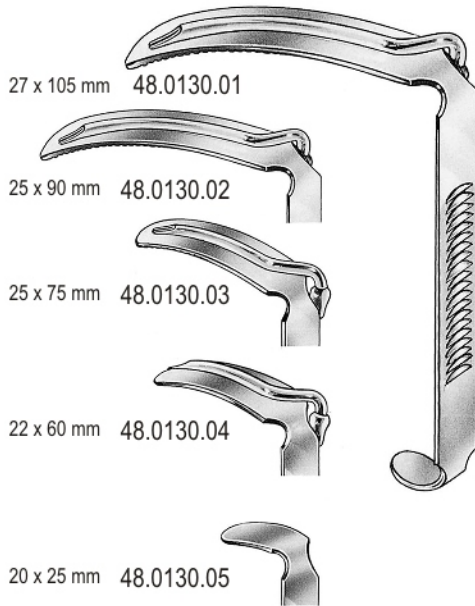

DAVIS-BOYLE

48.0130.00 compl. set

48.0130.10 frame only

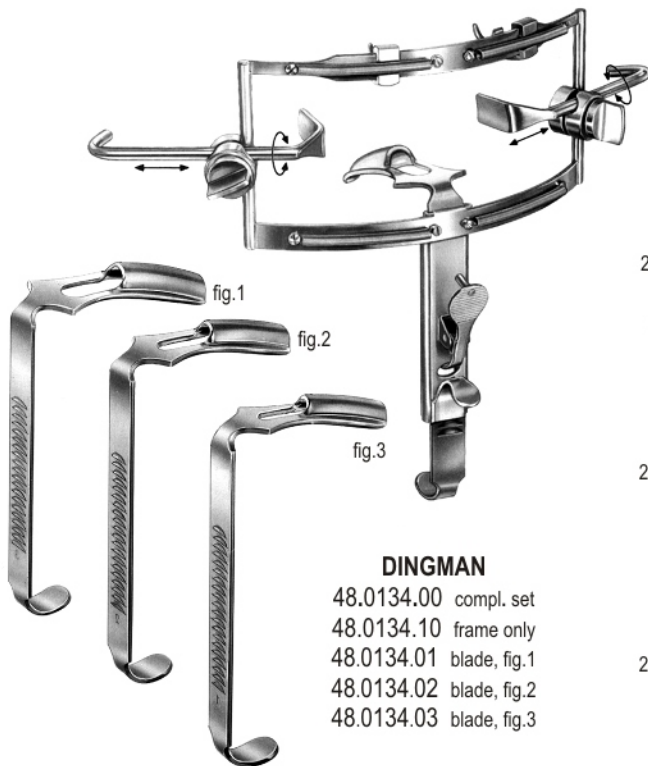

DINGMAN

48.0134.00 compl. set

48.0134.10 frame only

48.0134.01 blade, fig.1

48.0134.02 blade, fig.2

48.0134.03 blade, fig.3

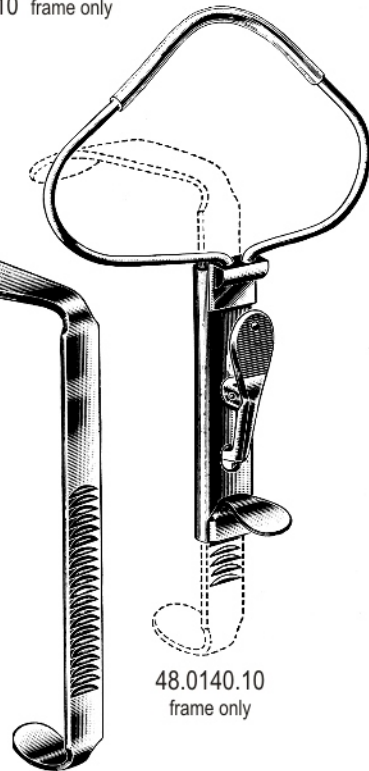
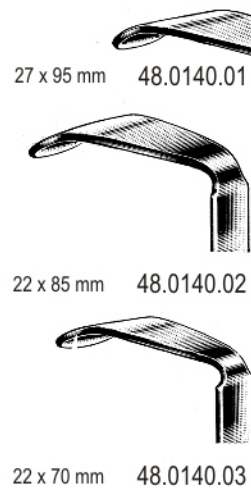

McIVOR

48.0140.00 compl. set

48.0140.10

48-004

www.hilbro.net



ORINGER
48.0144.10 - 48.0144.03

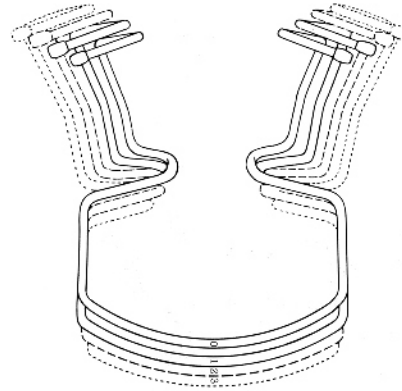

48.0144.00 set
48.0144.10 fig.0
48.0144.01 fig.1
48.0144.02 fig.2
48.0144.03 fig.3

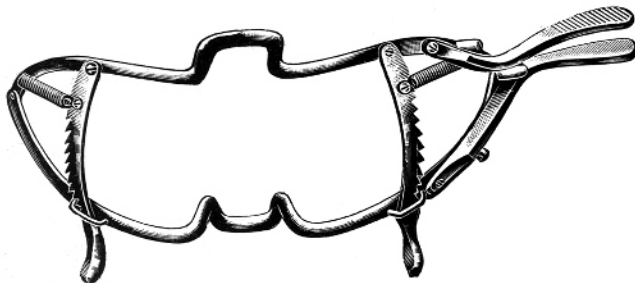

WHITEHEAD
48.0150.11 11.0cm
48.0150.13 13.0cm
48.0150.15 15.0cm

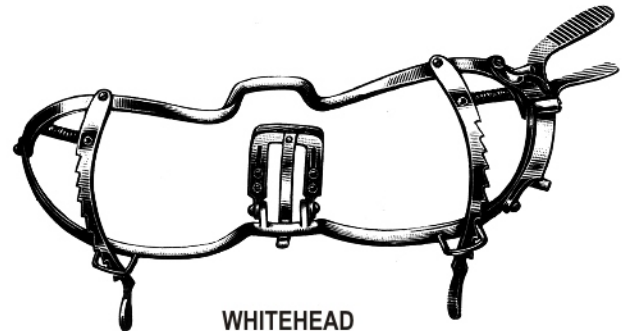

WHITEHEAD
48.0154.11 11.0cm
48.0154.13 13.0cm
48.0154.15 15.0cm

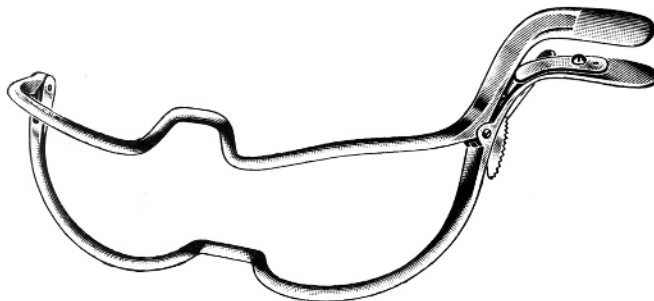

JENNINGS
48.0160.09 9.0cm
48.0160.11 11.0cm
48.0160.13 13.0cm
48.0160.15 15.0cm



SEEMANN-SEIFFERT (self-retaining)
48.0164.09 9.0cm
48.0164.11 11.0cm
48.0164.13 13.0cm
48.0164.15 15.0cm

48.0164.15

48-005

www.hilbro.net

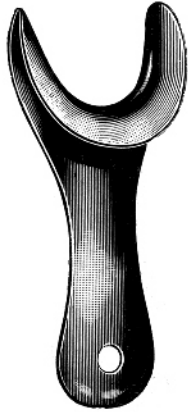

SIMPLEX
48.0170.11 11.0cm

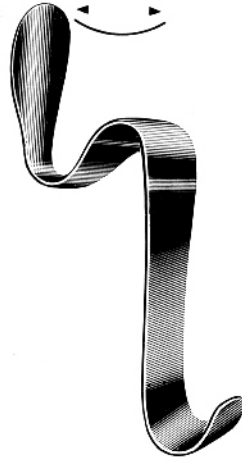

BISHOP
48.0174.13 13.0cm



CAWOOD
48.0180.15 15.5cm



48.0184.14 14.0cm



48.0186.18 18.5cm

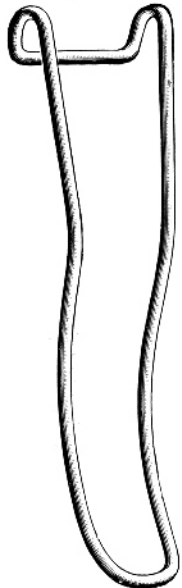

STERNBERG
48.0190.14 14.0cm
48.0190.16 16.0cm
48.0190.18 18.0cm



STERNBERG
48.0192.12 12.0cm
48.0192.14 14.0cm
48.0192.16 16.0cm



48.0200.19 19.0cm

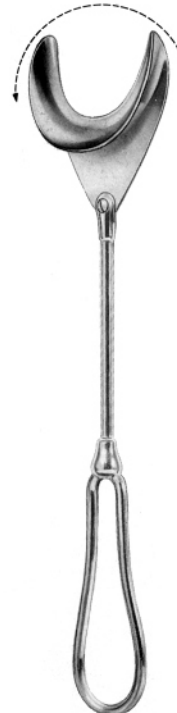

48.0200.21 21.0cm



ORIGINAL TESSIER
20.5cm
48.0204.01 for children
48.0204.02 for adults

Tongue Depressors EN

Zungendrucker DE

Abajalenguas ES

48

ORAL



LACK
12.0cm
48.0210.13 13mm
48.0210.19 19mm
48.0210.22 22mm

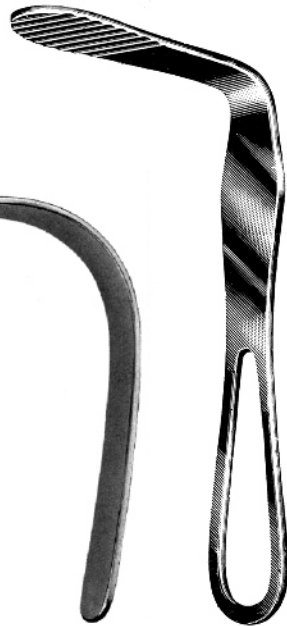

HARTMANN
48.0214.15 15.0cm

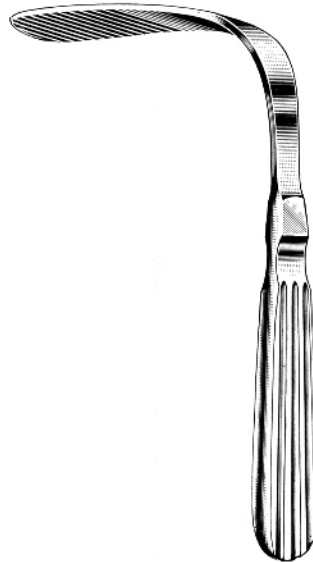

TOBOLD
48.0220.14 14.5cm

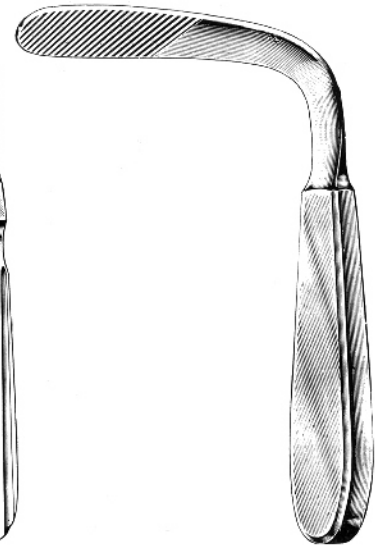

TOBOLD
48.0222.14 14.5cm

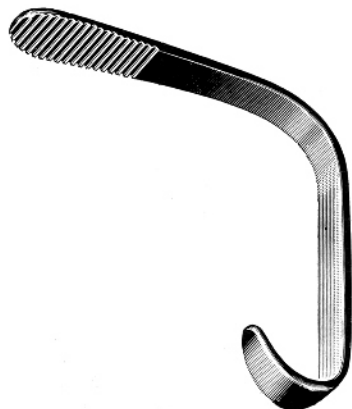

ANDREW
48.0226.11 11.0cm



WIEDER
48.0230.03 16.5cm

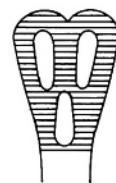

48.0230.01
14.0cm

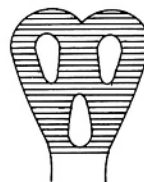

48.0230.02
15.0cm



WIEDER (modif)
48.0232.14 14.5cm
with fibre optic cable fitting

48.0232.14

48-007

www.hilbro.net

EN Tongue Depressors

DE Zungenspatel

ES Abaja-lengue

Hilbro

ORAL

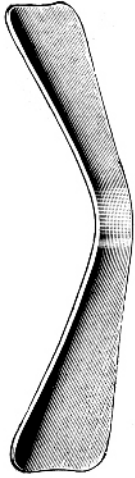

DOYEN
48.0236.13 13.0cm
48.0236.16 16.0cm



KROENIG
48.0240.15
15.0cm



MAYO
48.0244.17
17.0cm



BRUENINGS
48.0250.19
19.0cm

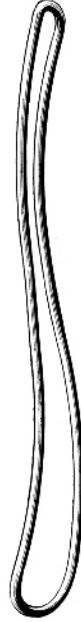

COLLIN
48.0254.16
16.5cm

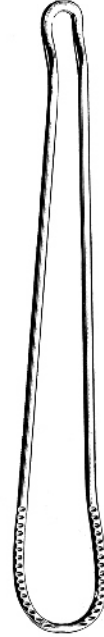

48.0260.16
16.5cm

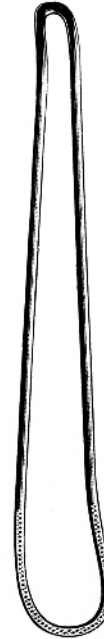

FRENZEL
48.0262.16
16.5cm

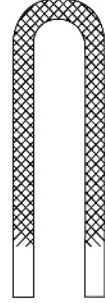

48.0294.14
14.5cm

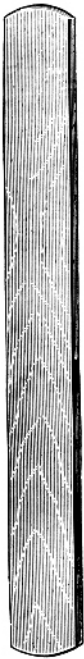

48.0266.16
16.0cm
of wood



48.0270.15
15.0cm
of plastic

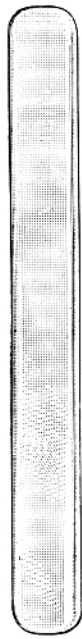

HAAS
48.0274.16
16.0cm
of acrylic glass

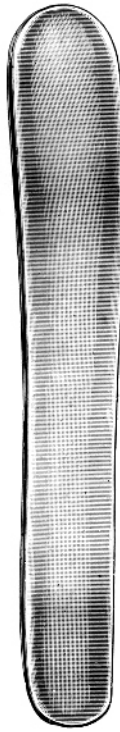

BUCHWALD
48.0280.17
17.0cm



48.0284.18
18.5cm
nylon boilable



48.0290.14
14.5cm

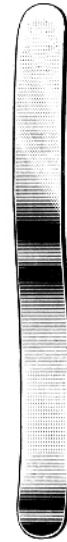

48.0294.14

48-008

www.hilbro.net

Tongue Holding Forceps EN

Zungenzangen DE

Pinza tira-lengua ES

48

ORAL

Hilbro

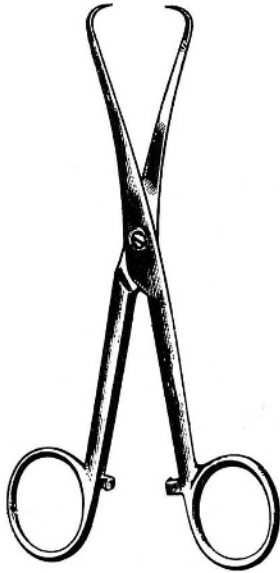

LOEBKER
48.0300.15 15.5cm

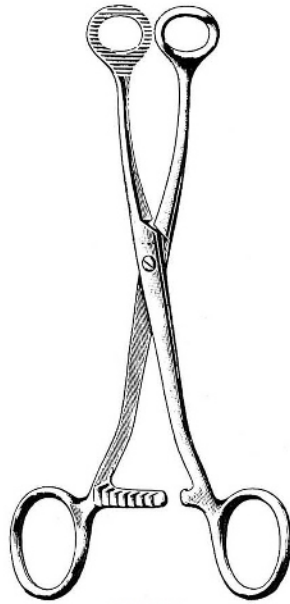

COLLIN
48.0304.16 16.0cm

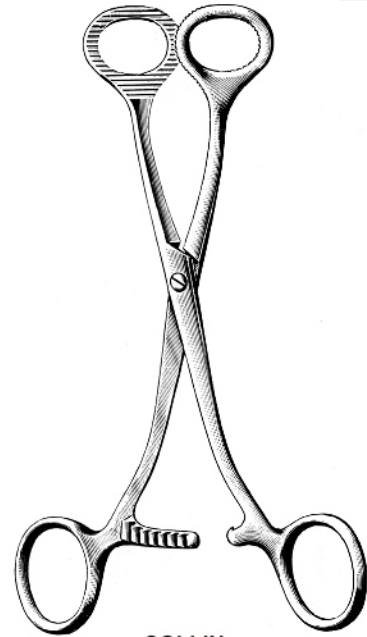

COLLIN
48.0306.17 17.0cm
48.0306.19 19.0cm

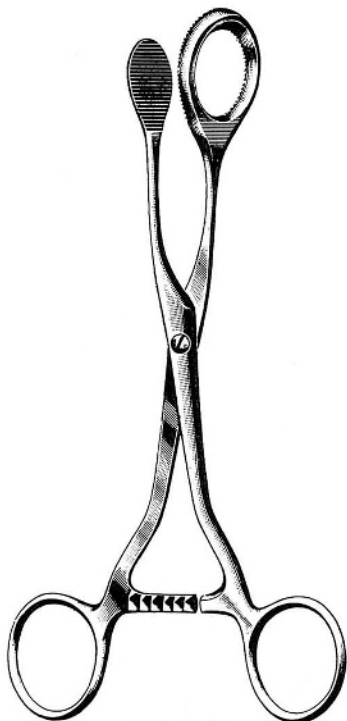

MATHIEU
48.0310.19 19.0cm



GUY
48.0314.19 19.0cm



YOUNG
48.0320.17 17.0cm

48.0320.02
pair

48.0320.17

48-009

www.hilbro.net

EN Scalpel Handles

DE Skalpellgriffe

ES Mangos de bisturi



ORAL



DUMBACH
48.0400.01 15.0cm
for blades, size 11 and 12



DUMBACH
48.0400.02 15.0cm
for blades, size 11,12 and 15



DUMBACH
48.0400.03 15.0cm
for blades, size 11,12 and 15



48.0404.15 15.0cm
for blades, size 9-17, 40 and 42



48.0410.14 14.5cm
No.3, straight



48.0411.14 14.5cm
No.3, angled



48.0412.16 16.0cm
No.4 straight



48.0413.16 16.0cm
No.4, angled

48.0413.16

48-010

www.hilbro.net

Septum Scissor EN
Septum Scheren DE
Tijeras pára tabique nasal ES

48

ORAL

Hilbro



CAPLAN
48.0420.21 21.5cm



CAPLAN
48.0422.21 21.0cm

48.0422.21

48-011

www.hilbro.net