

# RECTUM

# 54



PAGE 001 to 012



- EN Rectum
- DE Rektum
- ES Recto

SERVING HEALTHCARE WORLDWIDE



Rectal Specula EN

Mastdarm-Spekule DE

Especulos rectales ES

54

RECTUM

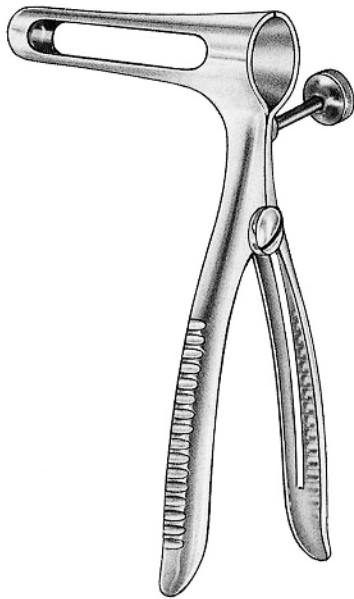

**SIMS**  
54.0010.15 15.0cm

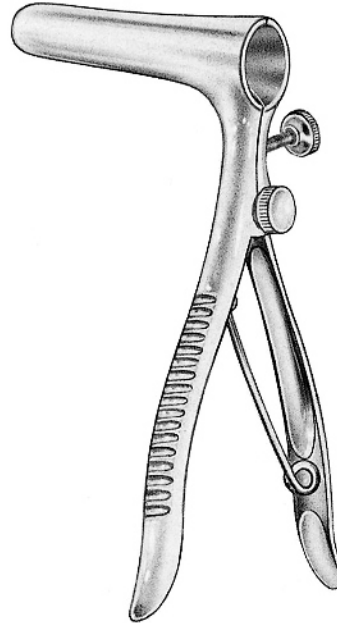

**SIMS**  
54.0012.15 15.0cm

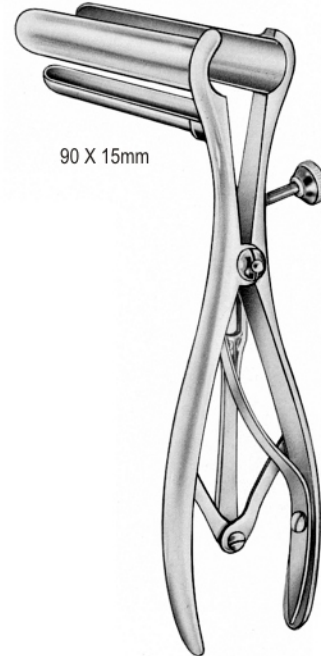

90 X 15mm

**MATHIEU**  
54.0020.19 19.5cm

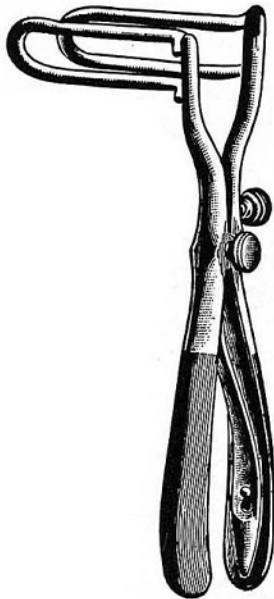

**SIMS**  
54.0030.15 15.0cm

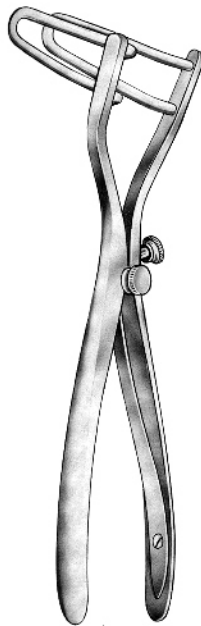

**SCHULZE-BERGMANN**  
22.0cm  
54.0040.06 60mm  
54.0040.08 80mm  
54.0040.12 125mm  
54.0040.15 150mm

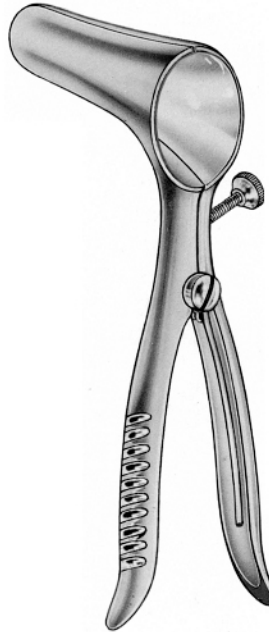

**PRATT**  
54.0050.21 21.5cm

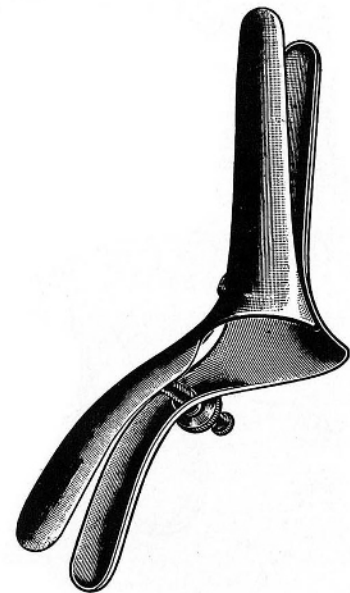

**RICORD**  
54.0060.00

54.0060.00

**54-001**

[www.hilbro.net](http://www.hilbro.net)

**KELLY**

54.0070.01 21mm Ø x 50mm

54.0070.02 27mm Ø x 50mm

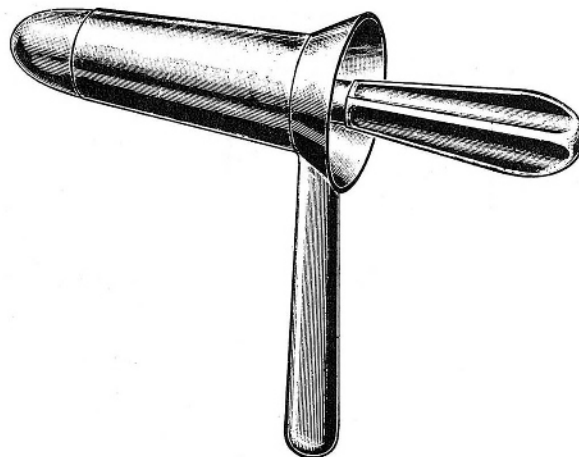
**KELLY**

54.0074.01 25mm Ø x 64mm

54.0074.02 22mm Ø x 35mm

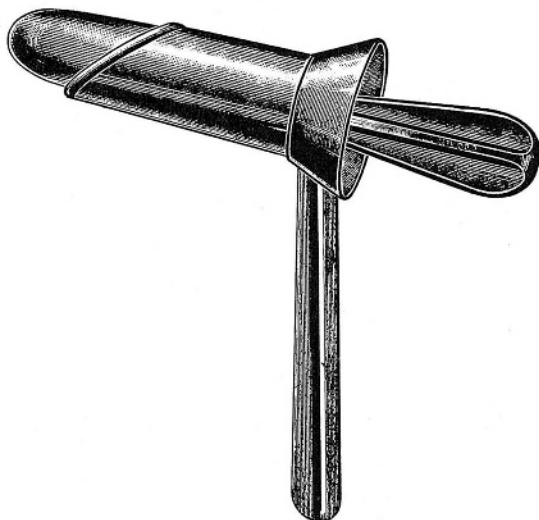
**GRAEME-ANDERSON**

54.0080.00 24mm Ø x 64mm

**GABRIEL**

54.0090.01 24mm Ø x 64mm

54.0090.02 19mm Ø x 49mm

54.0090.02

**54-002**

www.hilbro.net

Proctoscopes, Anoscope EN

Proktoskope, Anoskop DE

Proctoscopios y anoscopio ES

54

RECTUM

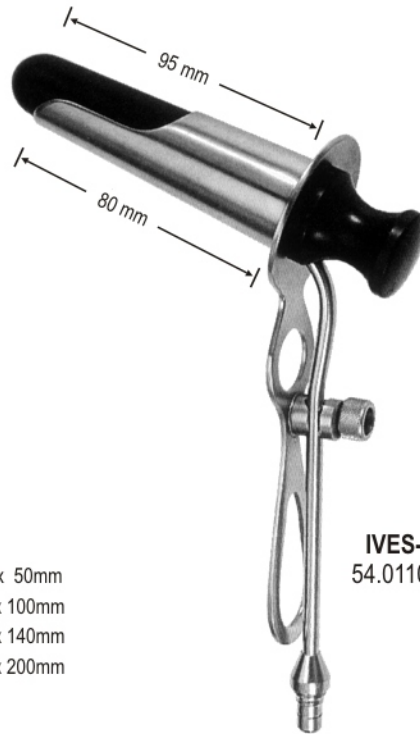

**IVES-FANSLER**  
54.0110.15 22mm Ø

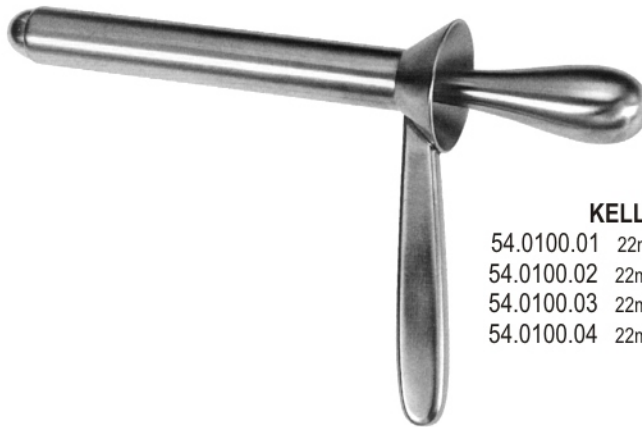

**KELLY**  
54.0100.01 22mm Ø x 50mm  
54.0100.02 22mm Ø x 100mm  
54.0100.03 22mm Ø x 140mm  
54.0100.04 22mm Ø x 200mm



**HIRSCHMANN**  
54.0120.01 16mm Ø x 65mm  
54.0120.02 19mm Ø x 65mm  
54.0120.03 22mm Ø x 65mm



**KELLY**  
54.0130.01 22mm Ø x 50mm  
54.0130.02 22mm Ø x 100mm  
54.0130.03 22mm Ø x 140mm

54.0130.03

**54-003**

[www.hilbro.net](http://www.hilbro.net)



EN Sphincteroscopes, Proctoscopes, Anoscopes

DE Sphinkteroskope, Proktoskope, Anuskope

ES Esfinteroscopios, proctoscopios, anoscopios

Hilbro

## RECTUM

**MOD. MARTIN**

54.0140.01 22mm Ø X 50mm  
 54.0140.02 22mm Ø X 75mm  
 54.0140.03 22mm Ø X 100mm

**NEWMAN**

54.0150.01 16mm Ø X 63mm  
 54.0150.02 19mm Ø X 63mm  
 54.0150.03 23mm Ø X 63mm

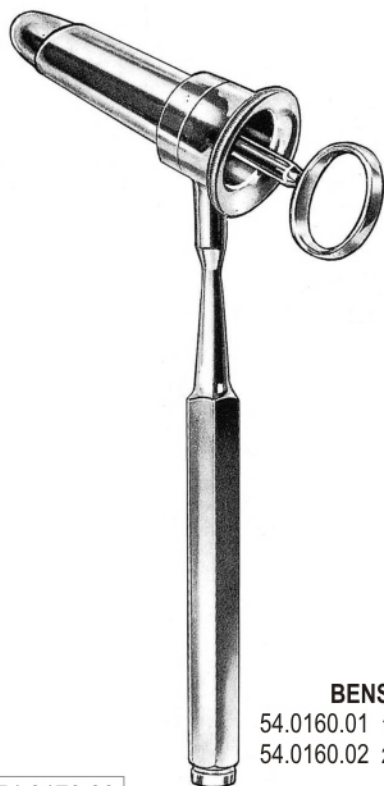
**BENSAUDE**

54.0160.01 19mmØ X 70mm  
 54.0160.02 22mmØ X 70mm

**NAUNTON-MORGAN**

54.0170.00 22mmØ X 70mm

54.0170.00

**54-004**

www.hilbro.net

RECTUM



**BARR**  
 54.0180.17 17.0cm

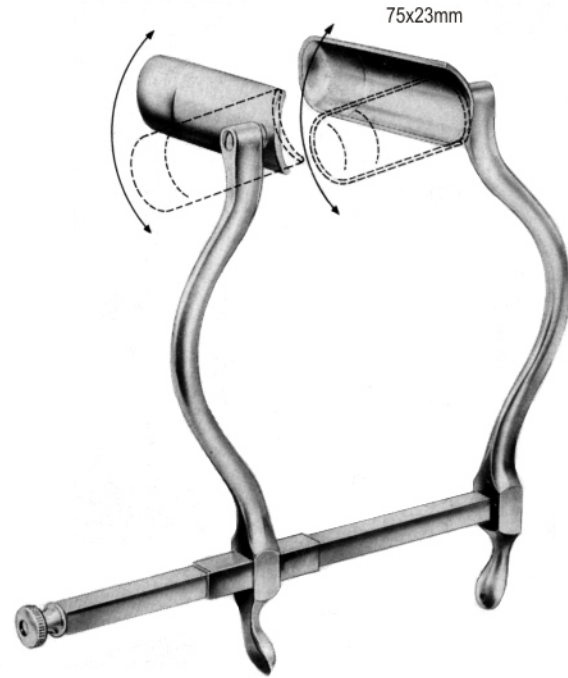

**SMITH-BUIE**  
 54.0190.15 15.0cm



**ALAN PARKS**  
 13.5cm  
 54.0200.00 complete  
 54.0200.04 centre blade  
 54.0200.13 frame only



54.0200.01  
 72mm



54.0200.02  
 90mm



54.0200.03  
 94mm

54.0200.13

**54-005**

www.hilbro.net

## RECTUM

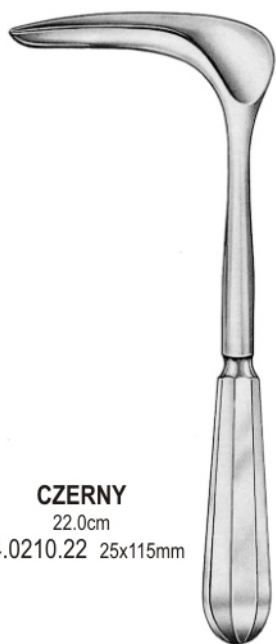

**CZERNY**  
 22.0cm  
 54.0210.22 25x115mm



**SAWYER**  
 23.0cm  
 54.0220.01 65x22mm  
 54.0220.02 75x28mm  
 54.0220.03 90x38mm



**FERGUSON-MOON**  
 21.0cm  
 54.0230.01 65x22mm  
 54.0230.02 75x28mm



**BUIE** 13.5cm  
 54.0240.13 light  
 54.0242.13 heavy



**LARRY**  
 54.0250.18  
 18.0cm



**ROSER**  
 54.0260.17  
 17.0cm



**PRATT**  
 22.0cm



54.0270.01



54.0270.02



54.0270.03

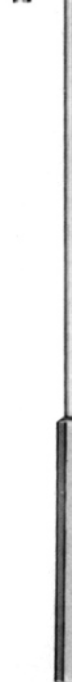

**BARR**  
 54.0280.23  
 23.0cm



**BARR**  
 54.0290.14  
 14.0cm

54.0290.14

**54-006**

www.hilbro.net

RECTUM

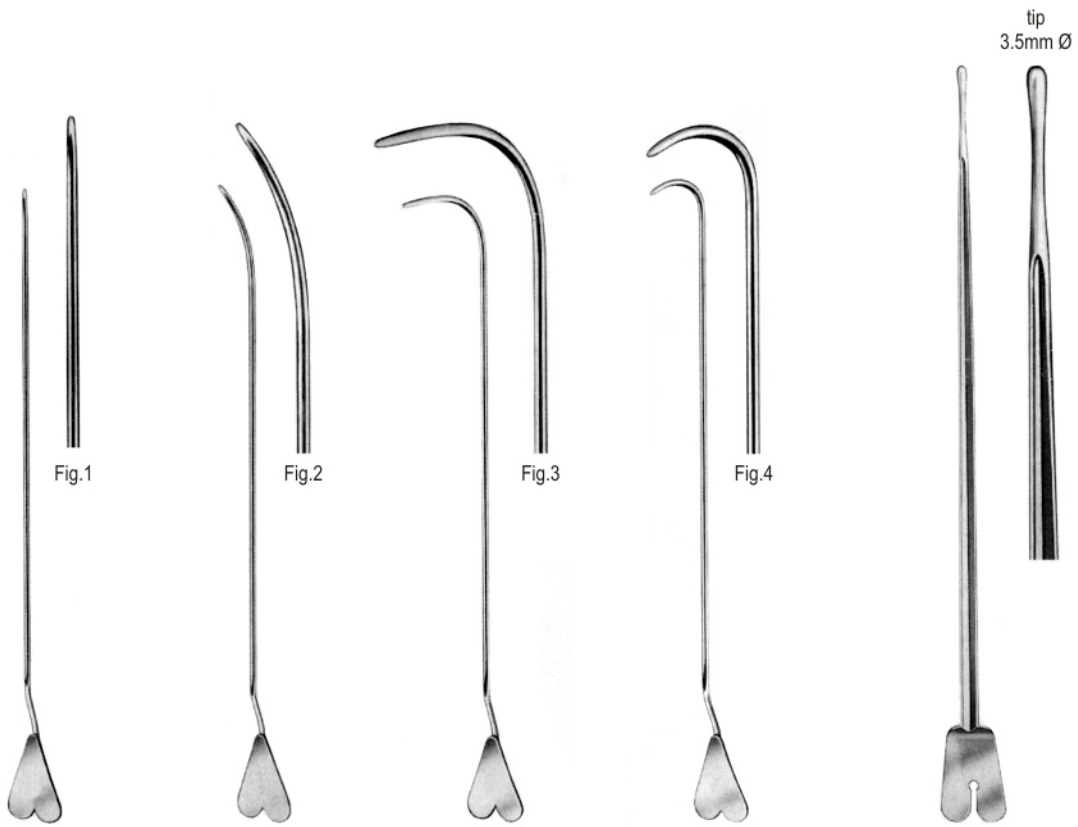

54.0300.01  
Fig.1 straight

54.0300.02  
Fig.2 45° curved

54.0300.03  
Fig.3 90° curved

54.0300.04  
Fig.4 retrograde curved

**BRODIE** 20.0cm

54.0310.20

**LOCKHART-MUMMERY** 16.5cm



# 54

EN Pelvis Retractors

DE Pelvishaken

ES Retractores de pelvis

**Hilbro**

## RECTUM

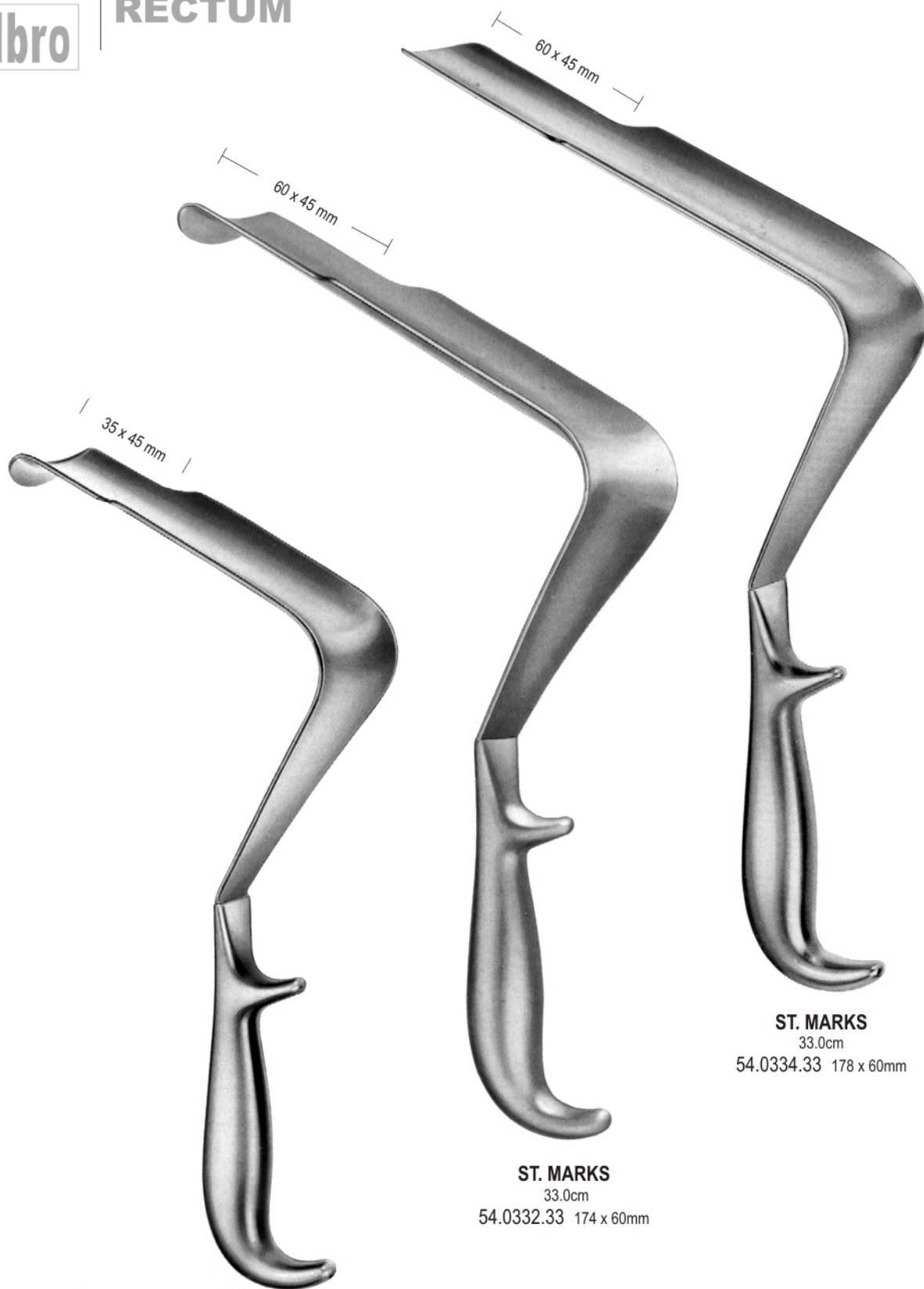

**ST. MARKS**  
33.0cm  
54.0334.33 178 x 60mm

**ST. MARKS**  
33.0cm  
54.0332.33 174 x 60mm

**ST. MARKS**  
29.0cm  
54.0330.29 124x60mm

54.0334.33

**54-008**

[www.hilbro.net](http://www.hilbro.net)

## RECTUM



54.0340.02  
ligature rubber rings

**McGIVNEY**  
54.0340.00 compl.  
54.0340.01 cone  
54.0340.02 100 '0' ring

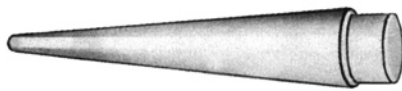
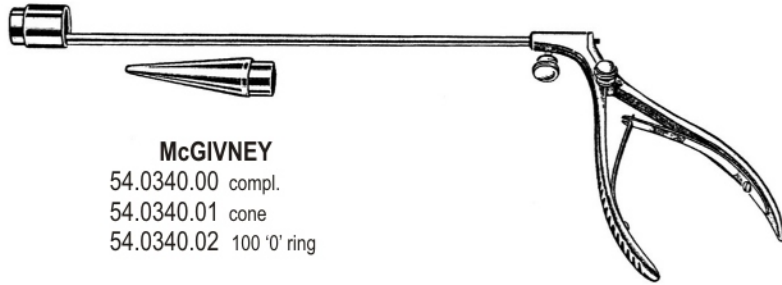

Loading Cone only  
54.0354.01

Suction Head  
54.0354.11 10x11mm  
54.0354.16 10x16mm

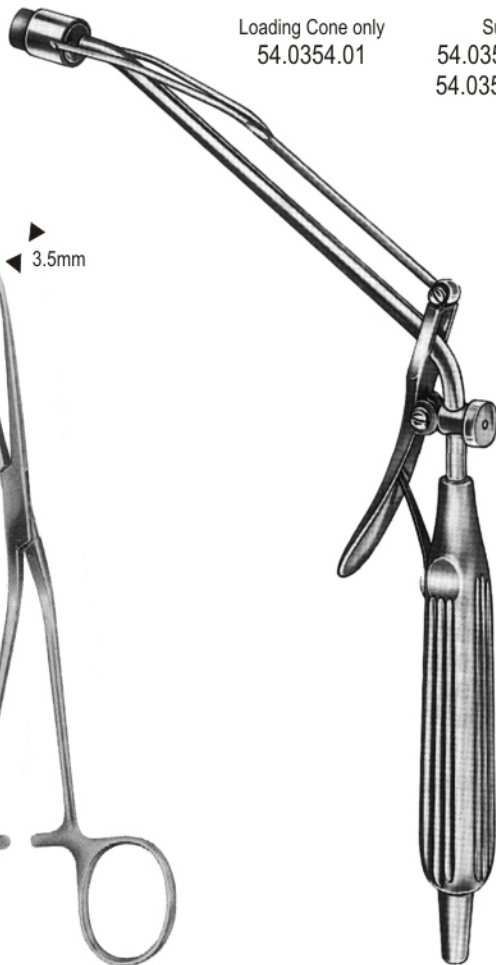

3.5mm



**McGIVNEY**  
54.0350.18 18.5cm

18.5cm  
54.0354.00 Set  
54.0354.01 Cone  
54.0354.11 Suction Head  
54.0354.16 Suction Head  
54.0340.02 100 '0' ring



**RUDD**  
54.0360.31 31.5cm  
54.0360.01 cone  
54.0340.02 100 '0' ring

54.0340.02

**54-009**

[www.hilbro.net](http://www.hilbro.net)

54

EN Rectal Biopsy Specimen Forceps, Haemorrhoidal (Pile) Forceps

DE Mastdarm-Biopsiezange, Hämorrhoidalzangen

ES Pinza sacabocado para biopsia rectal, pinzas-clamps hemorroidales

Hilbro

RECTUM

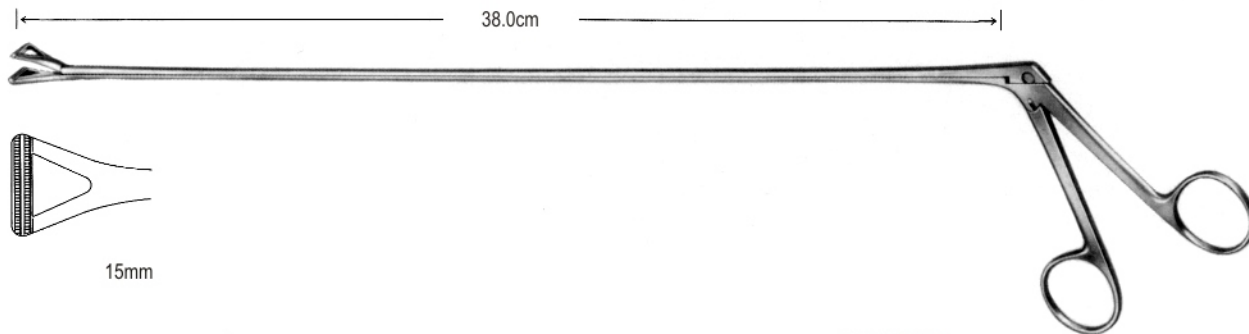

54.0370.38



HEYWOOD-SMITH  
54.0380.21 21.0cm

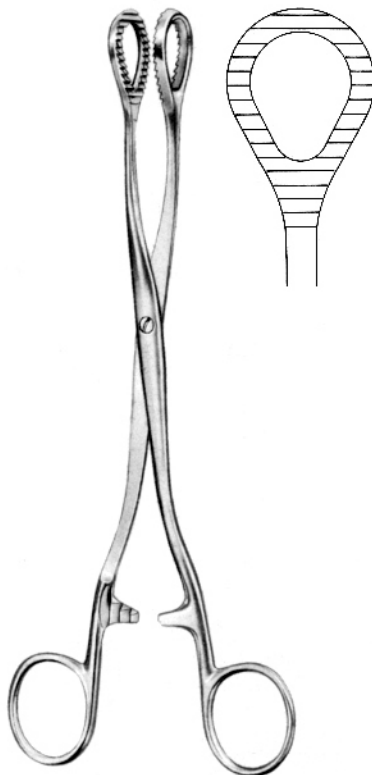
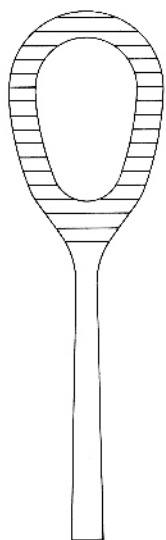

HEYWOOD-SMITH  
54.0382.20 20.0cm

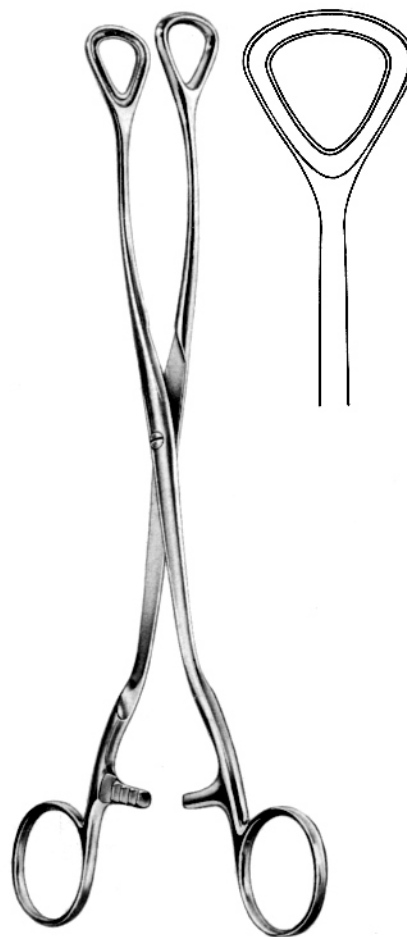
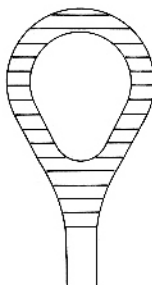

LUER  
54.0390.24 24.5cm

54.0390.24

54-010

www.hilbro.net

RECTUM

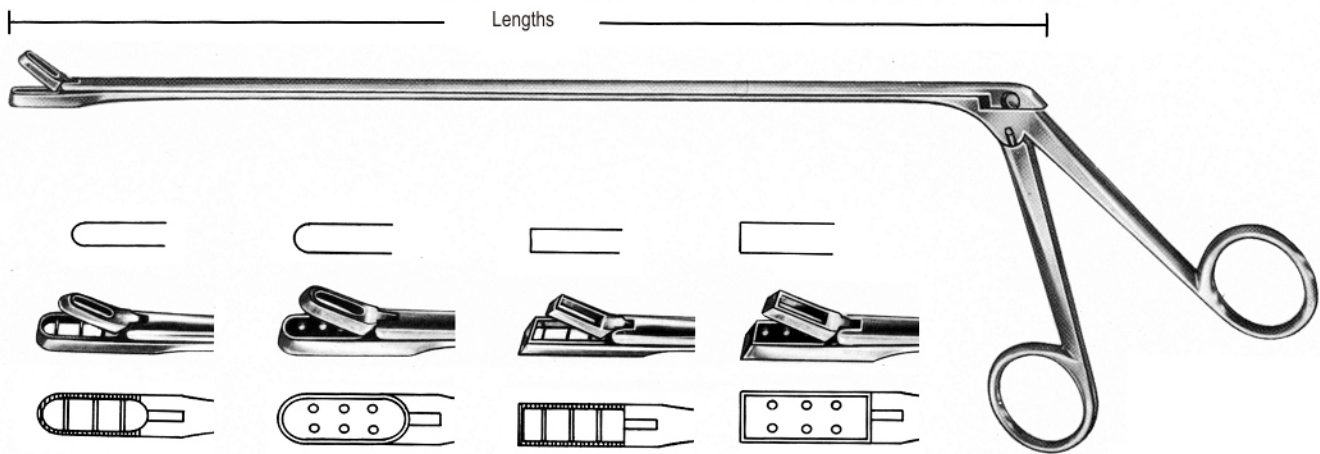
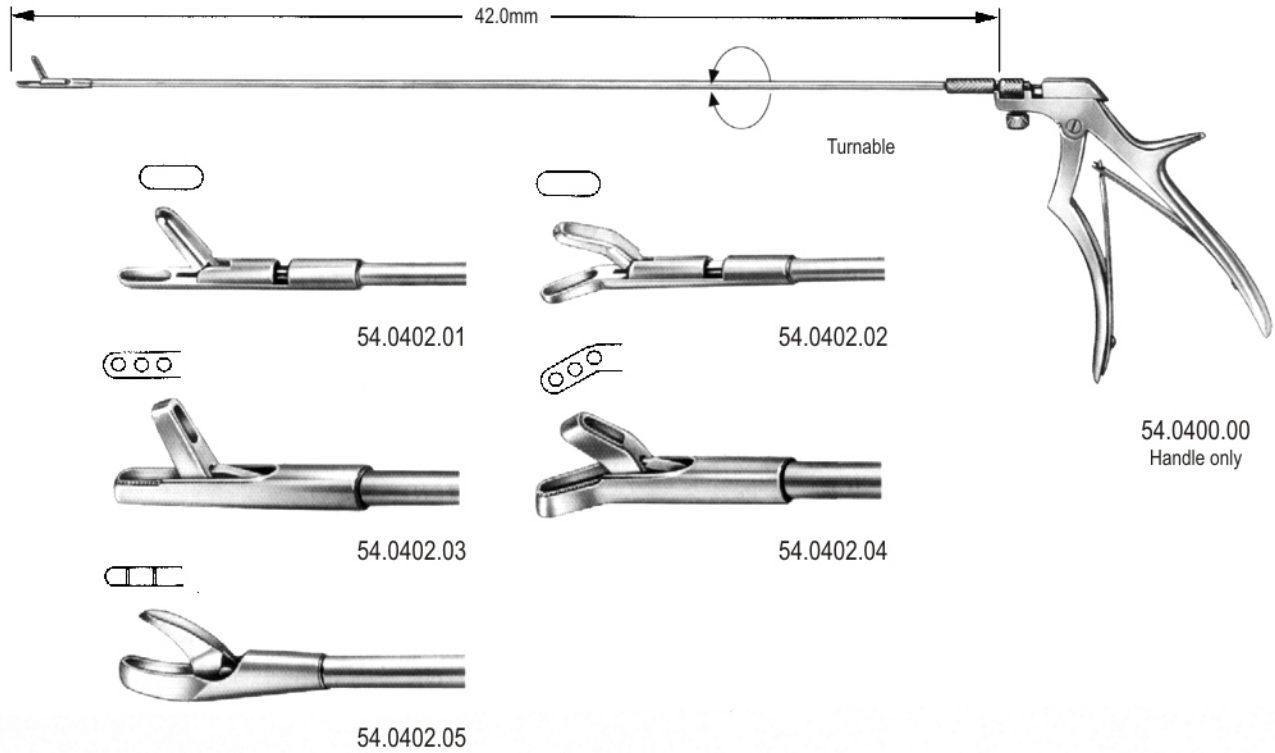

L/shaft	54.0410.28	54.0412.28	54.0414.28	54.0416.28
28.0cm	54.0410.28	54.0412.28	54.0414.28	54.0416.28
35.0cm	54.0410.35	54.0412.35	54.0414.35	54.0416.35
42.0cm	54.0410.42	54.0412.42	54.0414.42	54.0416.42

54.0416.42

54-011

www.hilbro.net

- EN Cotton Carrier For Rectoscope, Cotton Carriers  
 DE Swattatrageger Fur Rektoskope, Baumwollenboten  
 ES Posta algodón para rectoscopios, portadores de algodón

## RECTUM

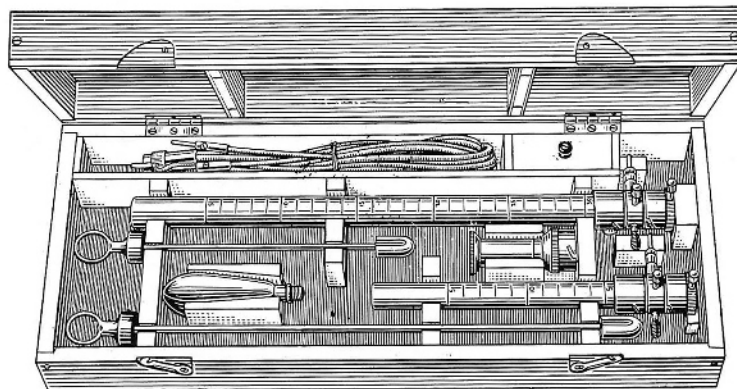

**LLOYDS-DAVIES**  
 54.0420.00 complete

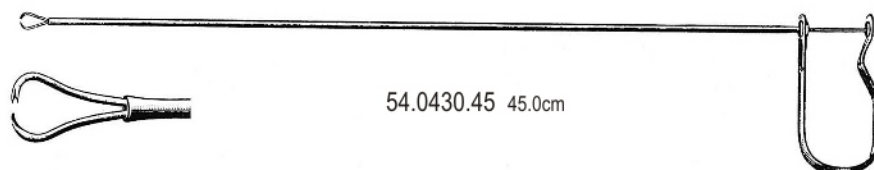

54.0430.45 45.0cm

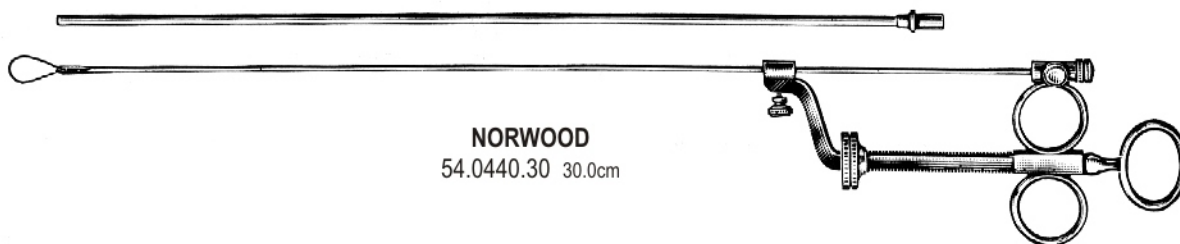

**NORWOOD**  
 54.0440.30 30.0cm

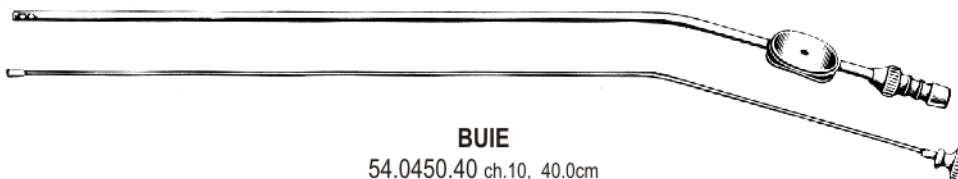

**BUIE**  
 54.0450.40 ch.10, 40.0cm

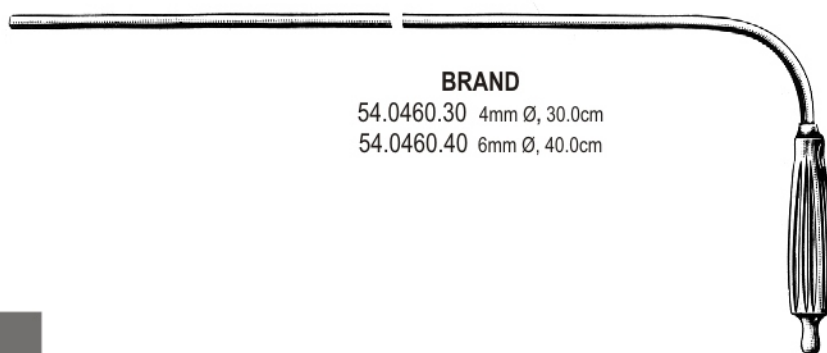

**BRAND**  
 54.0460.30 4mm Ø, 30.0cm  
 54.0460.40 6mm Ø, 40.0cm

54.0460.40

**54-012**

www.hilbro.net