

RHINOLOGY

46

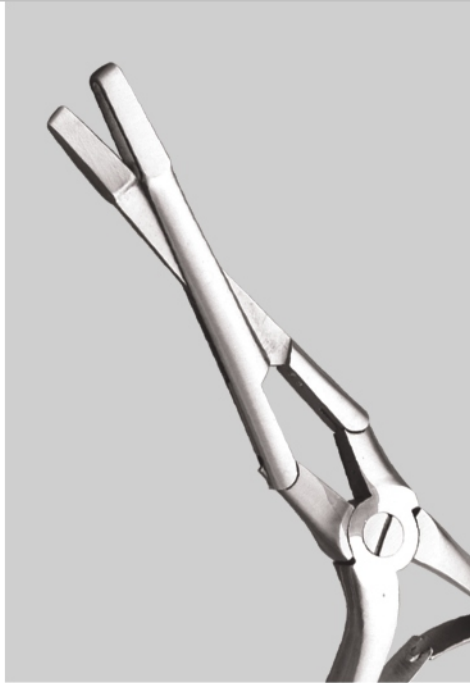

PAGE 001 to 034



- EN Rhinology
- DE Rhinologie
- ES Rinología

SERVING HEALTHCARE WORLDWIDE

www.hilbro.net



RHINOLOGY

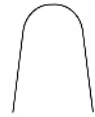

VACHER
46.0010.00



1 46.0014.01



2 46.0014.02



3 46.0014.03



VOLTOLINI

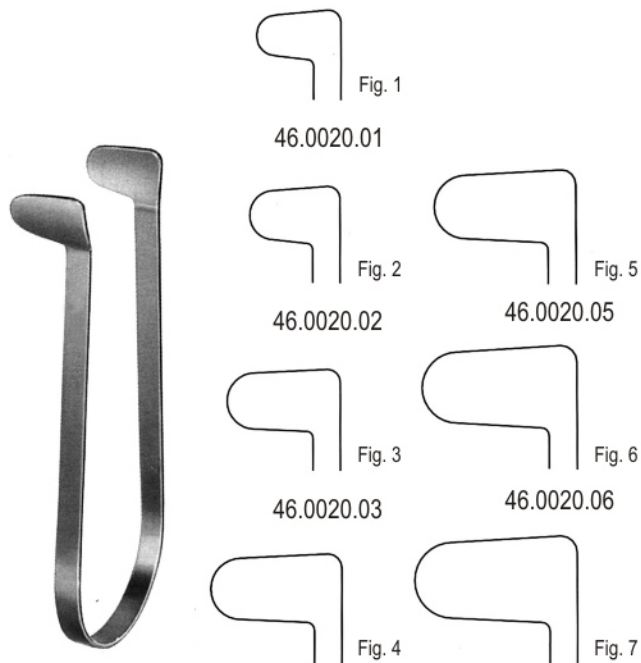

Fig. 1
46.0020.01

Fig. 2
46.0020.02

Fig. 3
46.0020.03

Fig. 4
46.0020.04

Fig. 5
46.0020.05

Fig. 6
46.0020.06

Fig. 7
46.0020.07

GOLDSMITH (Thudichum)
46.0020.00 set / 7

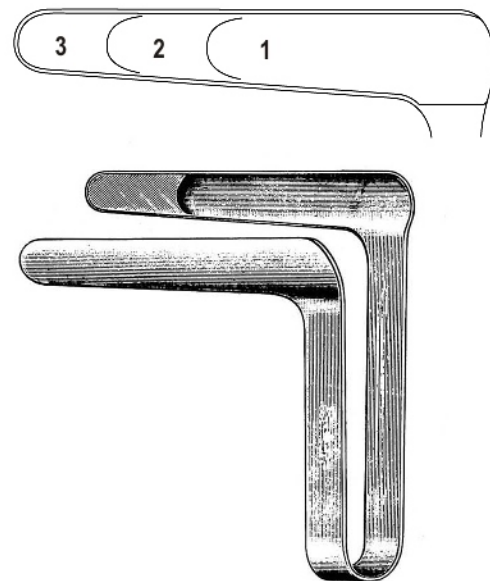

ST. CLAIR THOMSON
46.0024.00 set / 3
46.0024.01 35mm Fig. 1
46.0024.02 50mm Fig. 2
46.0024.03 75mm Fig. 3

46.0024.03

46-001

www.hilbro.net

EN Nasal Specula

DE Nasenspekula

ES Especulos nasales

Hilbro

RHINOLOGY

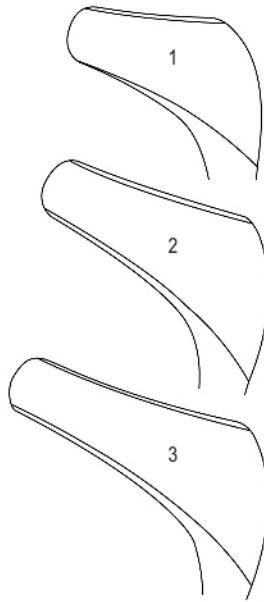

HARTMANN-HALLE

15.0cm

46.0030.01 Fig. 1

46.0030.02 Fig. 2

46.0030.03 Fig. 3

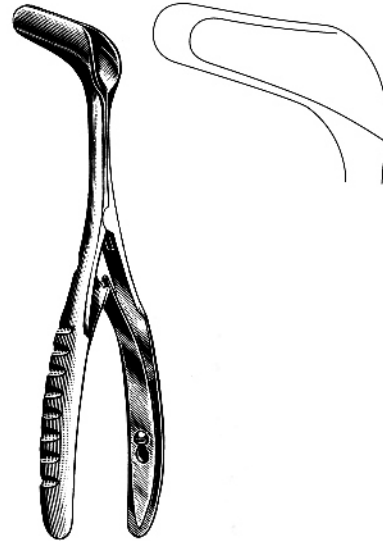

SCHWARZ

46.0036.14 14.0cm



VIENNA

14.5cm

46.0040.01 (infant)

46.0040.02 (child)

46.0040.03 (adult)

46.0040.04 (sheet metal)



MOD WIEN

46.0044.14 14.5cm

46.0044.14

46-002

www.hilbro.net

Nasal Specula EN

Nasenspekula DE

Especulos nasales ES

46

RHINOLOGY



Pediatrics

46.0048.13 13.0cm



46.0049.13 13.0cm



TIECK-HALLE
13.5cm
46.0052.01
46.0052.02



TIECK-HALLE
46.0056.13 13.5cm



KILLIAN
13.0cm
46.0060.35
46.0060.50
46.0060.75
46.0060.90

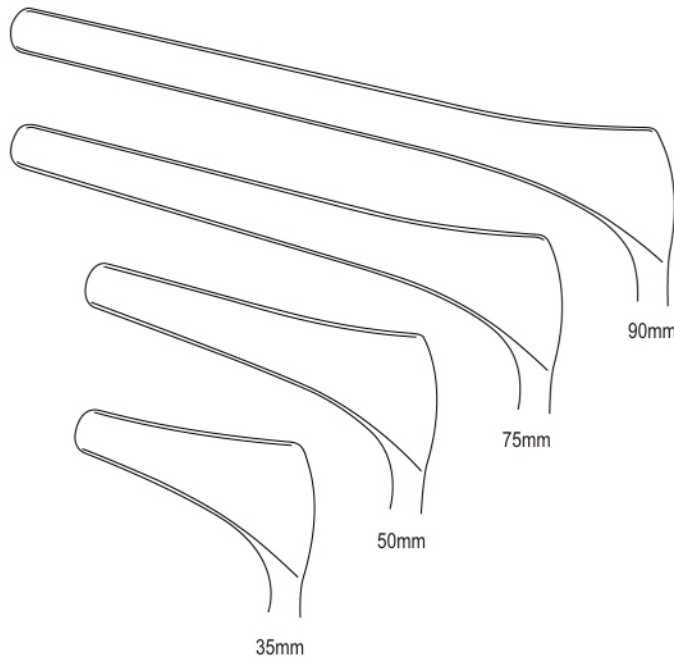

KILLIAN (with side screw)
13.0cm
46.0062.35
46.0062.50
46.0062.75
46.0062.90

46.0062.90

46-003

www.hilbro.net

EN Nasal Specula

DE Nasenspekula

ES Especulos nasales

Hilbro

RHINOLOGY



COTTLE

15.0cm

46.0070.35

46.0070.50

46.0070.75

46.0070.90

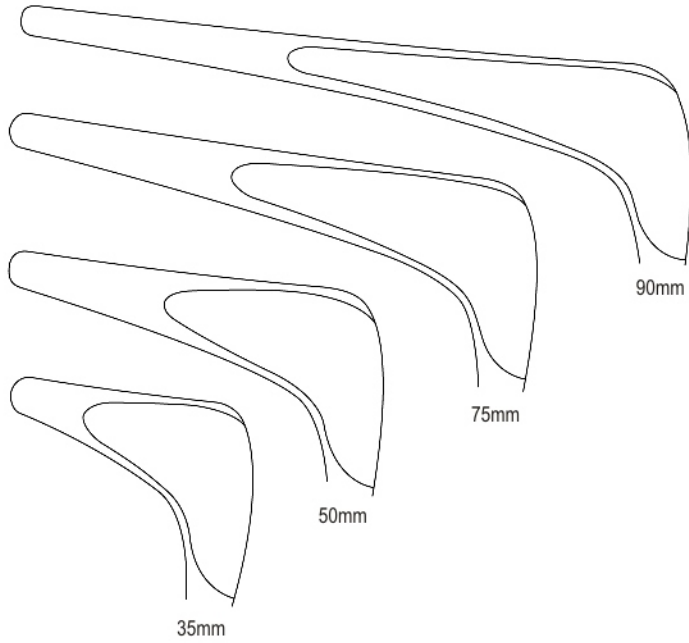

COTTLE (with side screw)

15.0cm

46.0072.35

46.0072.50

46.0072.75

46.0072.90



COTTLE

(dull black chromium plated)

14.0cm

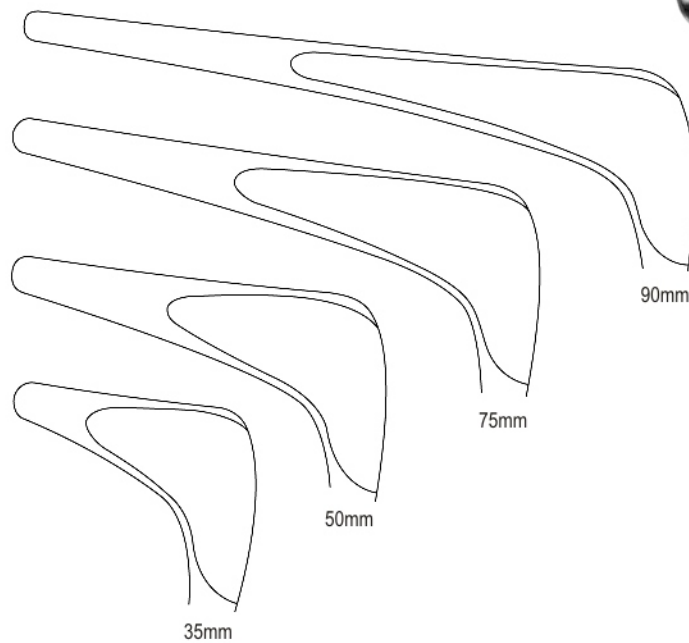

46.0076.35

46.0076.50

46.0076.75

46.0076.90

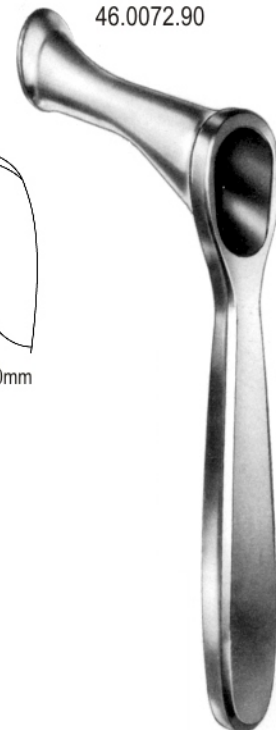

YANKAUER

46.0080.19 19.0cm

46.0080.19

46-004

www.hilbro.net

Nasal Snares EN

Polypenschnurer DE

Polipotomos ES

46

RHINOLOGY

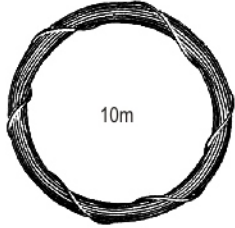

44.0270.03 0.3mm Ø
44.0270.04 0.4mm Ø



44.0274.02 0.2mm Ø
44.0274.03 0.3mm Ø



KRAUSE
46.0100.26 26.0cm

KRAUSE-VOSS
46.0104.26 26.0cm

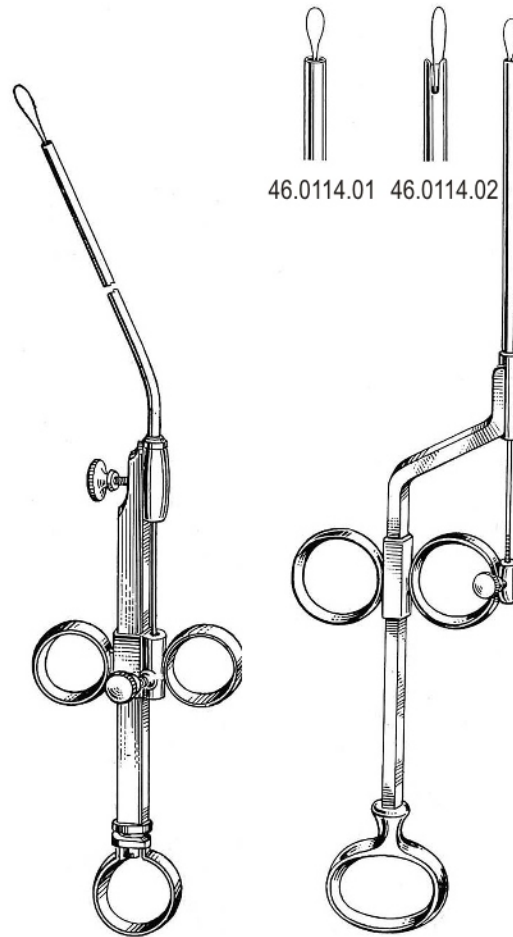

KRAUSE
46.0110.00

GLEGG

46.0114.01 46.0114.02

46.0114.02

46-005

www.hilbro.net

EN Nasal Polypus and Septum Compression Forceps

DE Polypenzangen, Septumzange

ES Pinzas para polipos, pinzas para el tabique nasal



RHINOLOGY



KILLIAN
46.0120.17 17.0cm



LITTAUER
46.0124.18 18.0cm

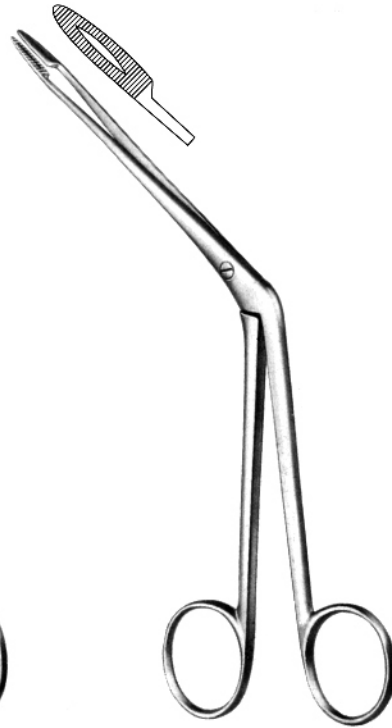

HARTMANN
46.0130.20 20.0cm



QUIRE
46.0134.12 12.0cm

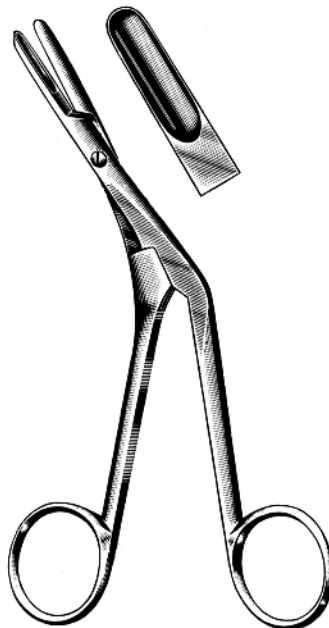

GRAIG
46.0140.18 18.0cm



46.0144.01 46.0144.02

18.0cm

46.0144.02

46-006

www.hilbro.net

Nasal Polypus and Septum Compression Forceps EN

Polypenzangen, Septumzange DE

Pinzas para polipos, pinzas para el tabique nasal ES

46

RHINOLOGY



KNIGHT
46.0150.18 18.0cm

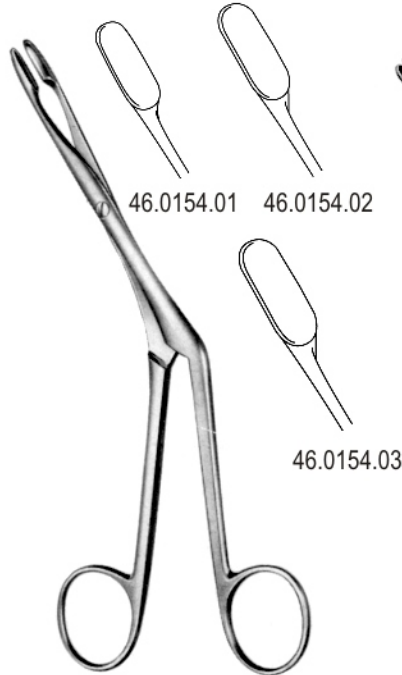

HEYMANN
18.0cm

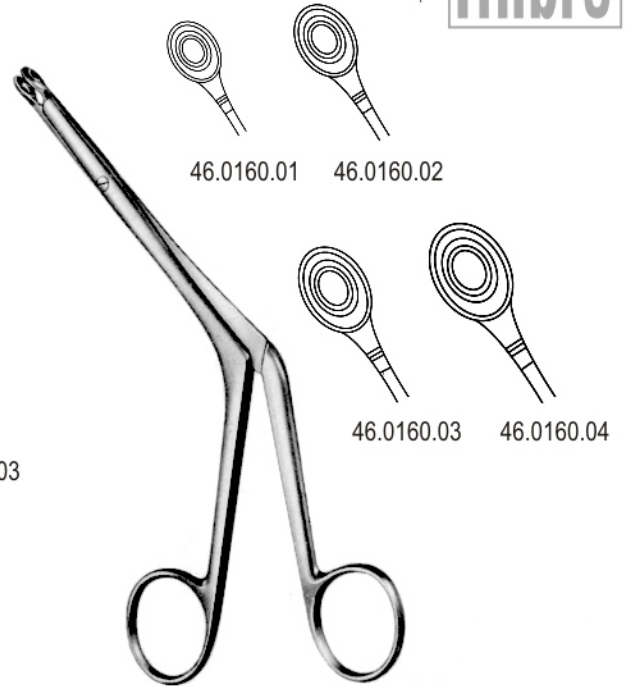

BRUENINGS
19.0cm

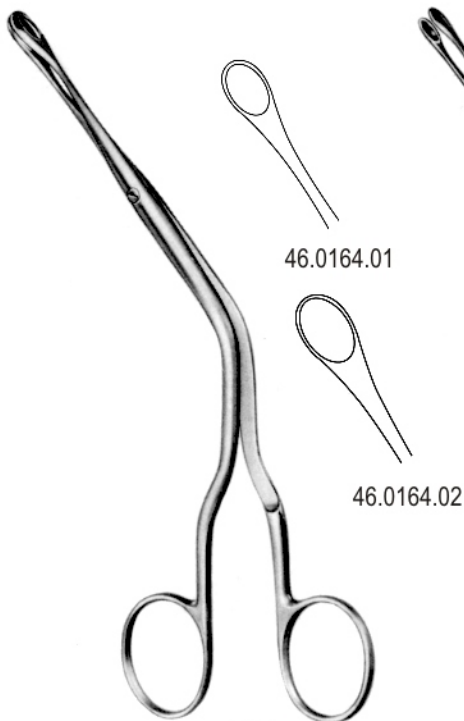

LUC
20.0cm

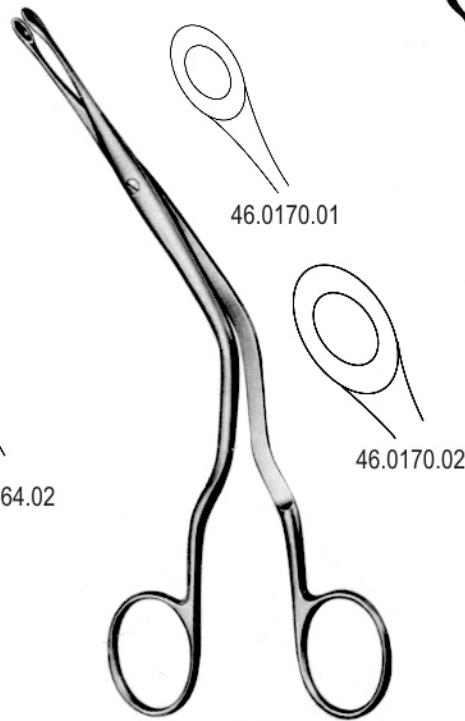

LUC
20.0cm

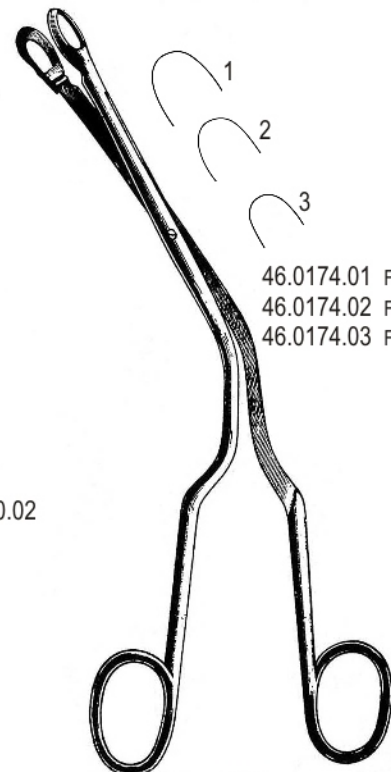

LUC
20.0cm

46.0174.01 Fig. 1
46.0174.02 Fig. 2
46.0174.03 Fig. 3

46.0174.03

46-007

www.hilbro.net

EN Dressing and Tampon Forceps, Nasal Polypus Forceps

DE Tamponpinzetten und-zangen, Polypenzangen

ES Pinzas para compresas y taponamientos, pinzas para pollipos



RHINOLOGY

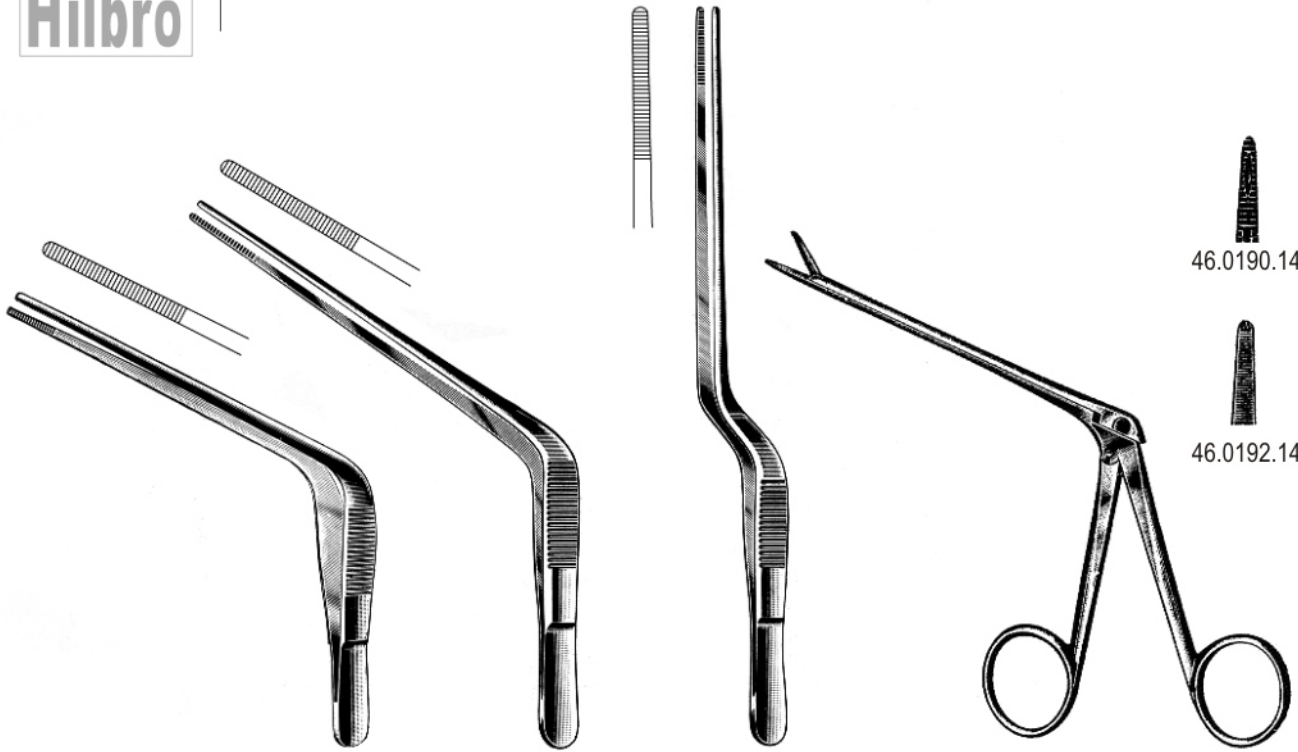

TROELTSCH
46.0180.15 15.0cm

TROELTSCH
46.0182.18 18.0cm

GRUENWALD (JANZEN)
46.0186.20 20.0cm

NOYES
14.5cm

46.0190.14

46.0192.14

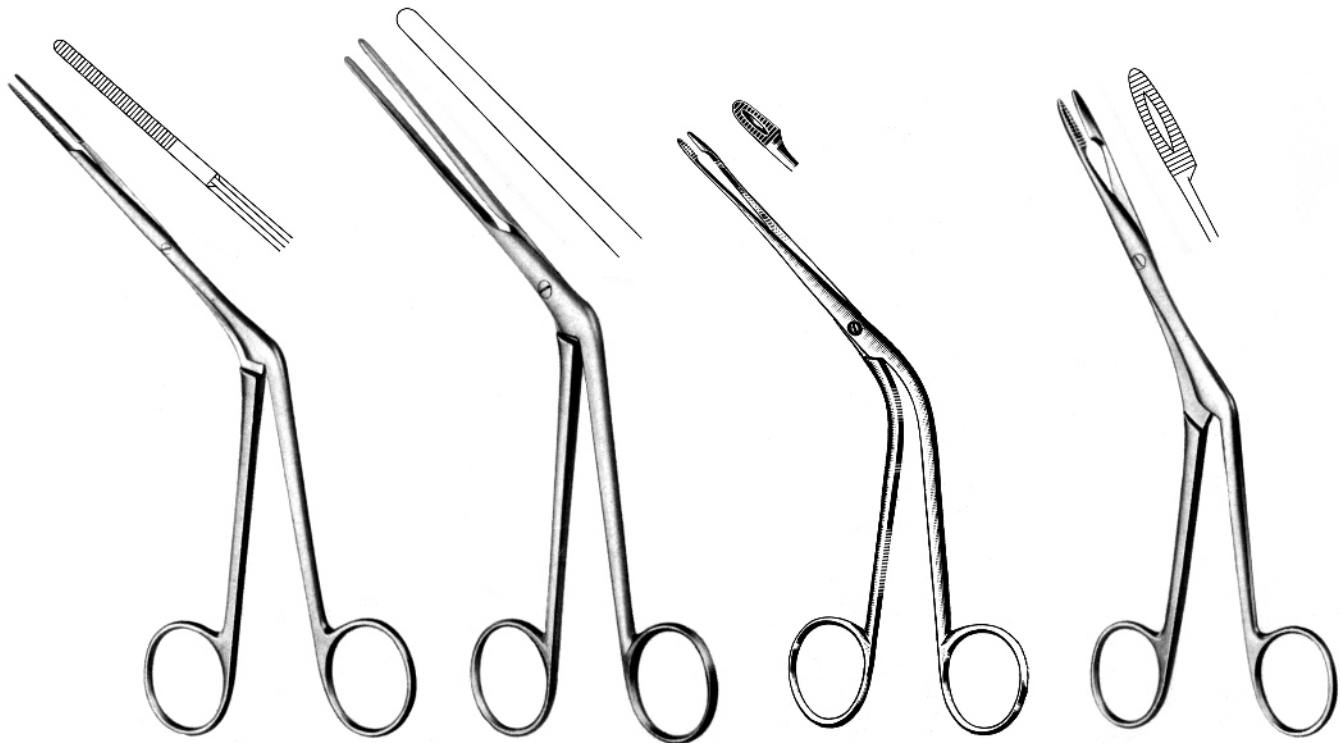

WESTMACOTT
46.0196.20
20.0cm

LUBET-BARBON
46.0200.20
20.0cm

HARTMANN
46.0204.16
16.0cm

HEYMANN-KNIGHT
46.0210.18
18.0cm

46.0210.18

46-008

www.hilbro.net

RHINOLOGY

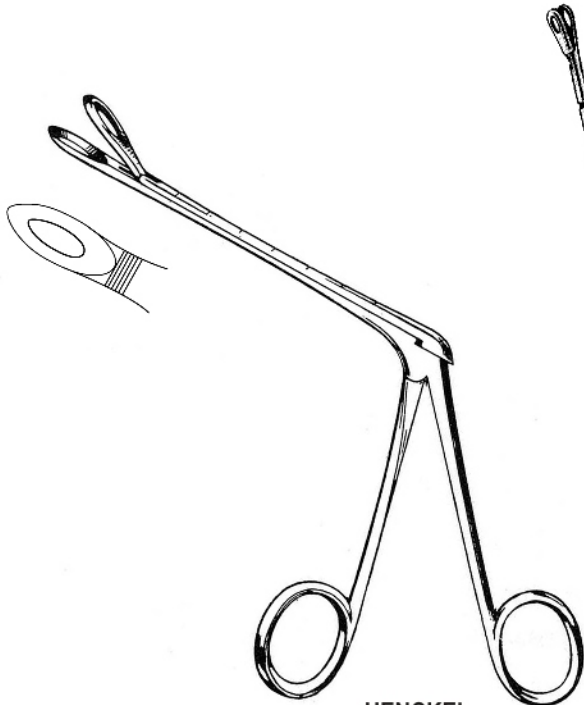

HENCKEL
 46.0214.20 20.0cm



JATHO
 46.0220.15 24.0cm

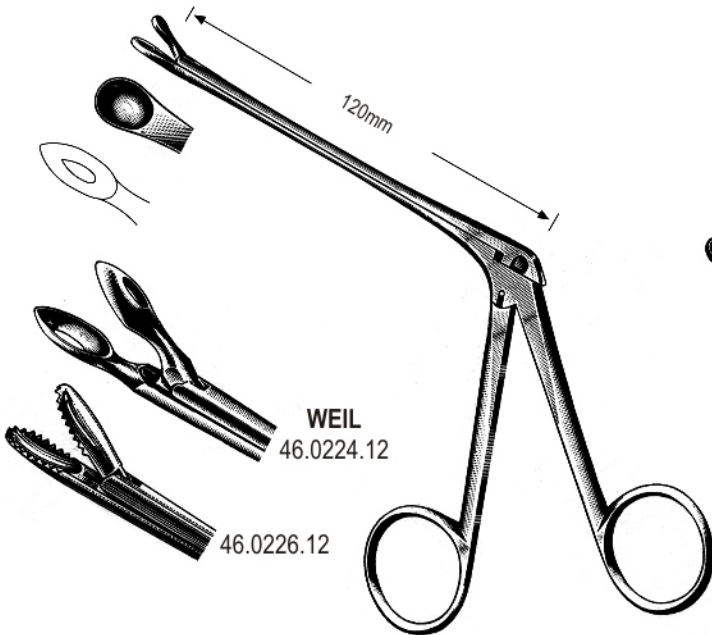

WATSON-WILLIAMS
 46.0222.12 19.0cm

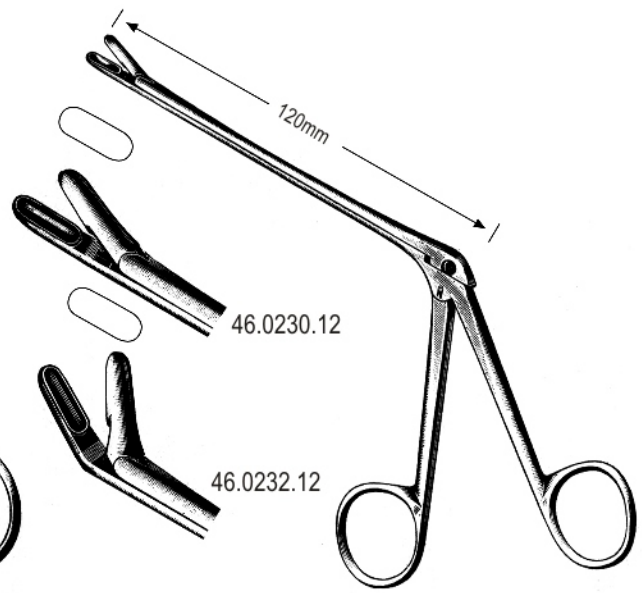

TAKAHASHI
 19.0cm

46.0232.12

46-009

www.hilbro.net

RHINOLOGY

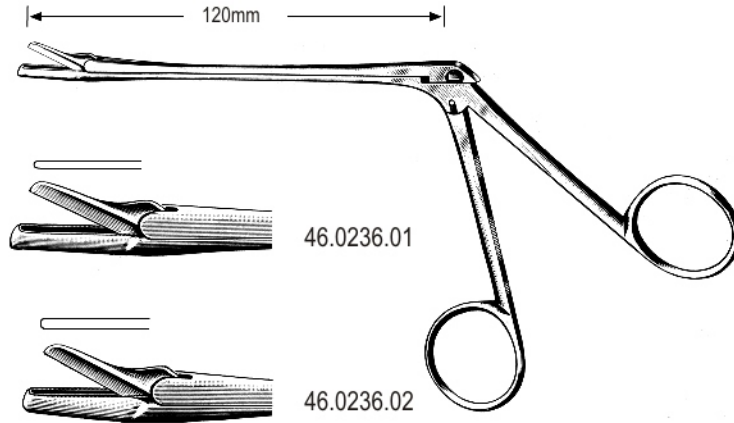

STRUYCKEN
19.0cm

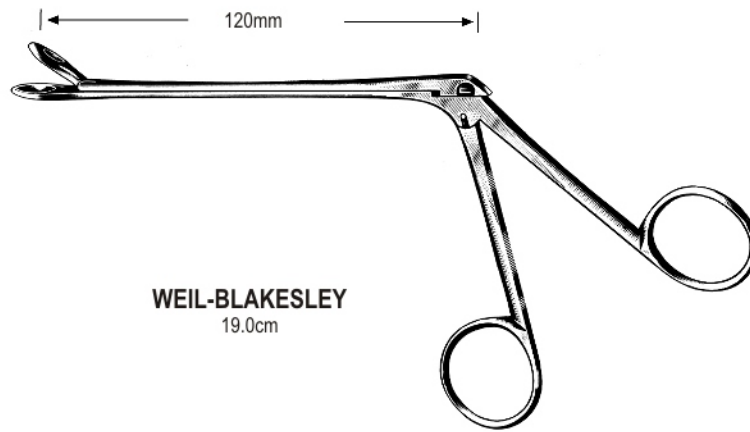

WEIL-BLAKESLEY
19.0cm

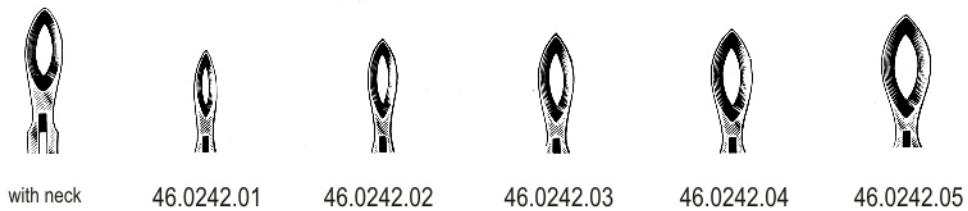
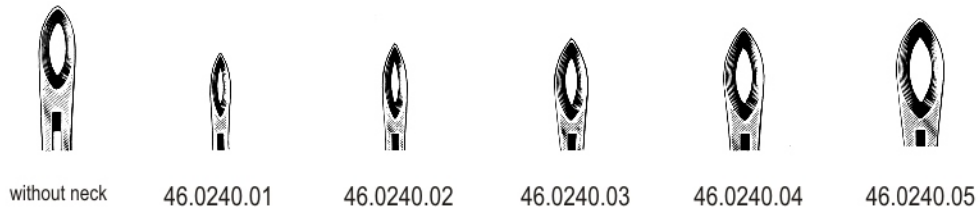

46.0242.05

46-010

www.hilbro.net

RHINOLOGY

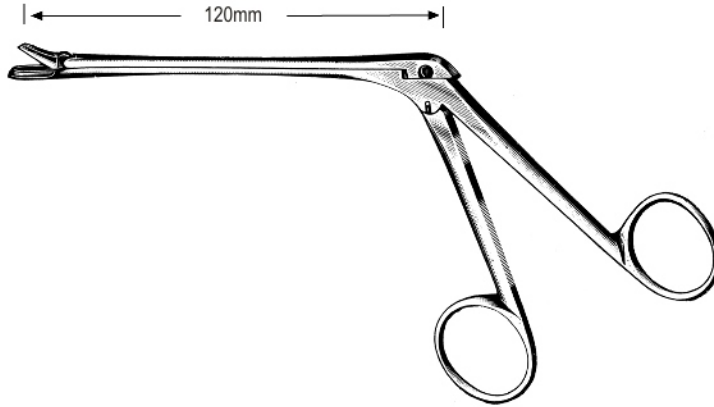

HAJEK
19.0cm

46.0250.12

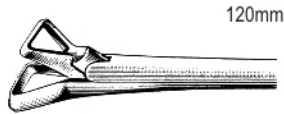

SCHMEDEN
19.0cm

46.0254.12

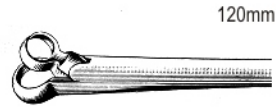

HARTMANN
19.0cm

46.0260.01 5mm
 46.0260.02 7mm
 46.0260.03 9mm
 46.0260.04 11mm

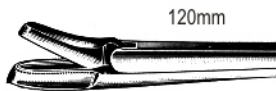

MYLES
19.0 cm

46.0264.01 2.2mm
 46.0264.02 2.6mm
 46.0264.03 3mm
 46.0264.04 3.4mm
 46.0270.01 5mm
 46.0270.02 7mm
 46.0270.03 9mm

46.0270.03

46-011

www.hilbro.net

RHINOLOGY

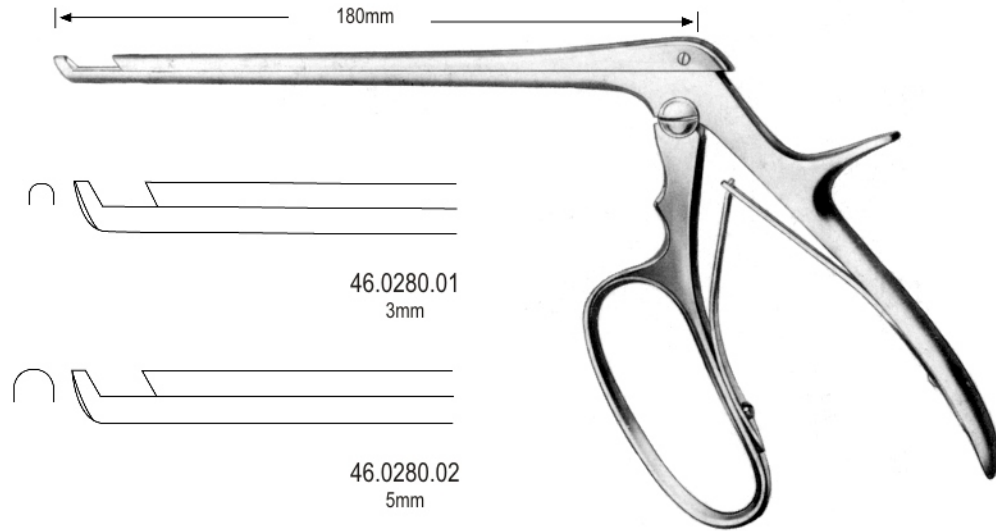

**FERRIS-SMITH-KERRISON
(CLOWARD HARPER)**

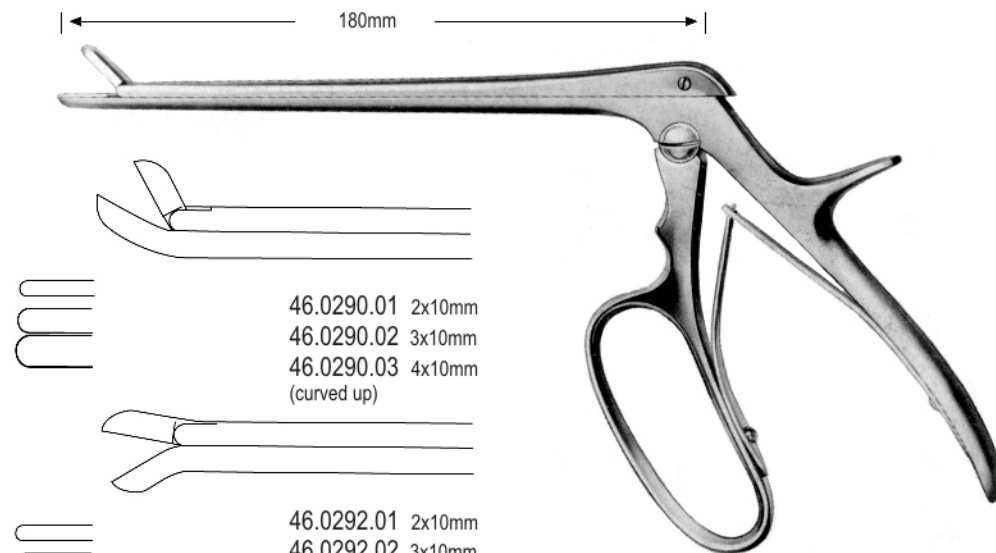

FERRIS-SMITH-CUSHING

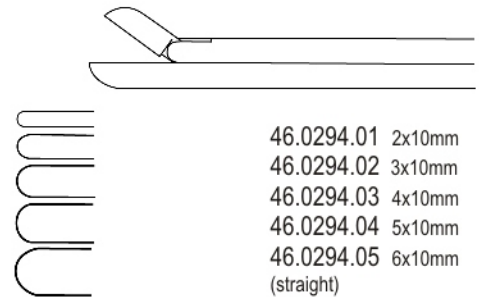

- 46.0294.01 2x10mm
- 46.0294.02 3x10mm
- 46.0294.03 4x10mm
- 46.0294.04 5x10mm
- 46.0294.05 6x10mm (straight)

46.0294.05

46-012

www.hilbro.net

RHINOLOGY

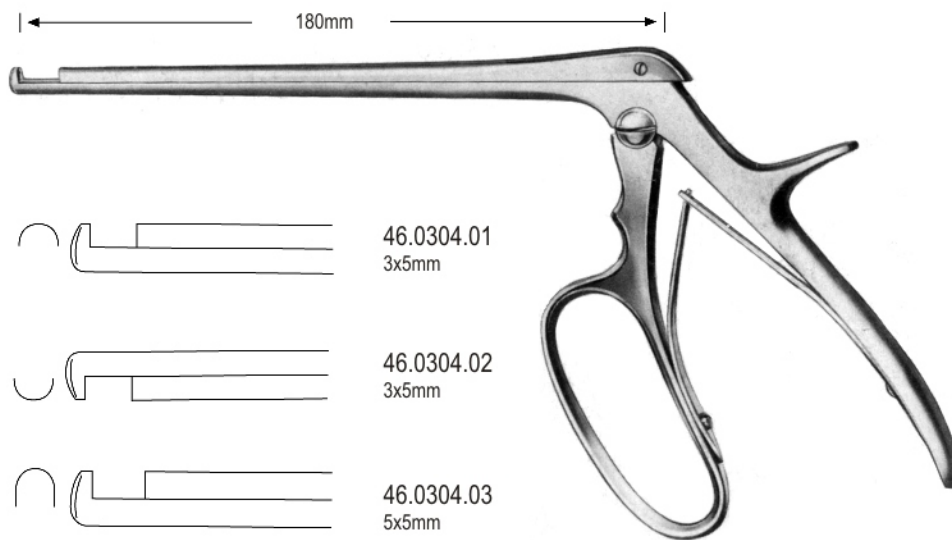
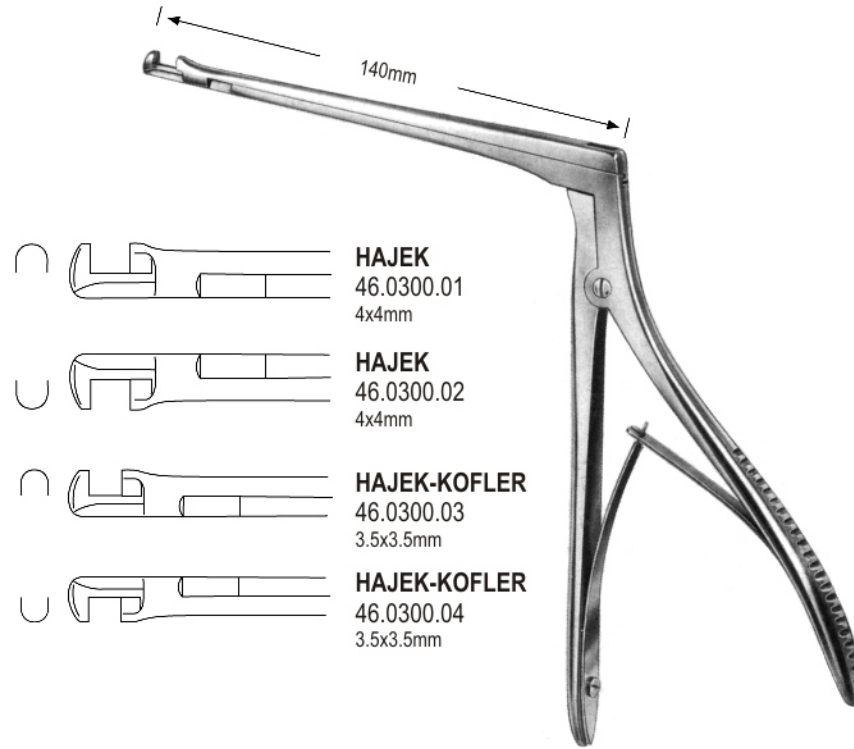

FERRIS-SMITH-KERRISON

46.0304.04

46-013

www.hilbro.net

EN Sphenoid Punches, Antrum Punch Forceps

DE Keilbeinstanzen, Kieferhohlenstanzen

ES Pinzas cortantes para seno esfenoidal y maxilar



RHINOLOGY

- 4x4mm  46.0310.01
4mm
- 5x5mm  46.0310.02
5mm
- 6x6mm  46.0310.03
6mm



KERRISON
20.0cm



HAJEK-CLAUS
46.0312.20 20.0cm



CITELLI
46.0314.10 1mm
46.0314.25 2.5mm
46.0314.30 3mm
46.0314.35 3.5mm
46.0314.40 4mm



BEYER
46.0316.19 2mm



BEYER
46.0318.19 1mm

46.0318.19

46-014

www.hilbro.net

RHINOLOGY



JANSEN-STRUYCKEN
46.0320.19 19.0cm



MIDDLETON-JANSEN
46.0322.19 19.0cm



MIDDLETON-JANSEN
46.0324.19 19.0cm



CAPLAN
46.0330.20
20.0cm



KILLIAN
46.0334.21
21.0cm



RUBIN
46.0340.21
21.0cm

46.0340.21

46-015

www.hilbro.net

RHINOLOGY



JOSEPH (sharp)
15.0cm

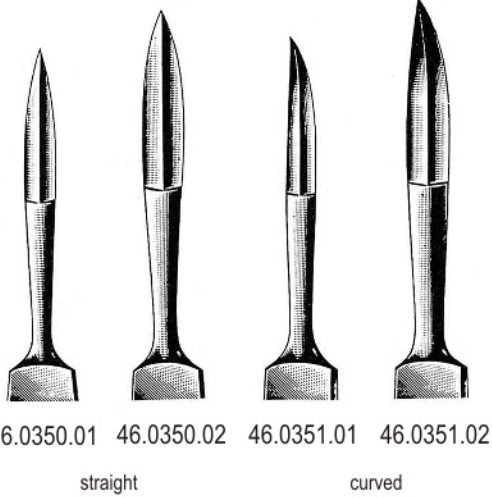

46.0350.01 46.0350.02 46.0351.01 46.0351.02
 straight curved



JOSEPH (blunt)
15.0cm

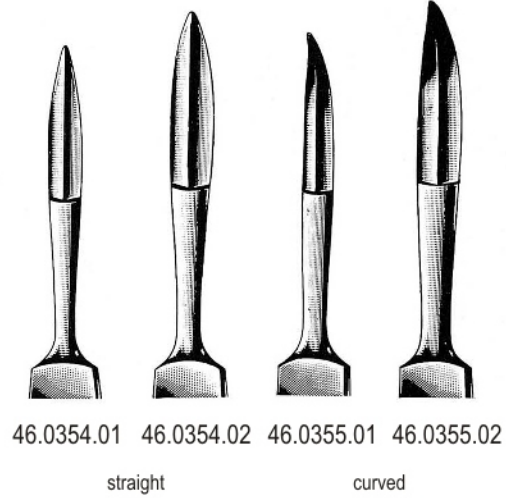

46.0354.01 46.0354.02 46.0355.01 46.0355.02
 straight curved



BALLENGER
46.0360.00



FOMON
46.0364.16
16.0cm



CONVERSE
46.0370.16
16.0cm

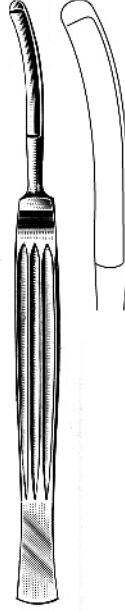

JOSEPH
46.0374.15
15.0cm

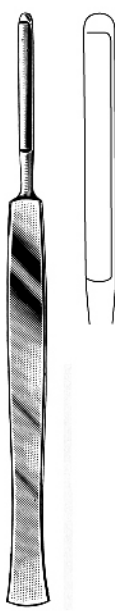

COTTLE
46.0380.15
15.0cm

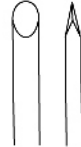

COTTLE
46.0384.15
15.0cm

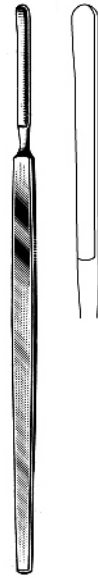

HEYMANN
46.0390.00



KRIEG
46.0394.00



46.0394.00

46-016

www.hilbro.net

Septum Knife, Mucous Knives, Swivel Knives EN

Septummesser, Mukosamesser, Schwingmesser DE

Cuchillo para el tabique nasal, la mucosa, cuchillos y hojas movibles ES

46

RHINOLOGY



BALLENGER
20.0cm



46.0400.03
3mm



46.0400.04
4mm



46.0400.05
5mm



BALLENGER
20.0cm



46.0401.03
3mm



46.0401.04
4mm



46.0401.05
5mm



BRUENINGS
46.0404.16 16.5cm



FREER
46.0406.00



FREER
46.0408.15
15.0cm



FREER
46.0410.19
19.0cm



FREER
46.0412.19
19.0cm



FREER
46.0414.19
19.0cm



FREER
46.0416.19
19.0cm

46.0416.19

46-017

www.hilbro.net

RHINOLOGY



McKENTY
15.0cm

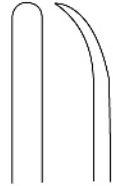

46.0420.04
4mm

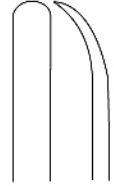

46.0420.05
5mm



HALLE
46.0424.16
16.5cm



JOSEPH
46.0430.16
16.0cm



FREER
46.0434.19
19.0cm



sharp



FREER
46.0436.19
19.0cm



blunt



FREER
46.0440.18
18.0cm



sharp



blunt



BALLENGER
46.0444.22
22.0cm

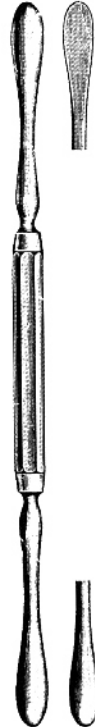

HAJEK-BALLENGER
46.0450.22
22.0cm



FREER
46.0454.20
20.5cm



sharp



blunt

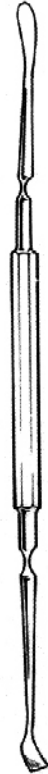

FREER
46.0460.20
20.0cm



DURHAM
46.0464.19
19.0cm



HOWARTH
46.0470.22
22.0cm



HILL
46.0474.22
22.0cm

46.0474.22

46-018

www.hilbro.net

Septum and Periosteal Elevators EN

Septum-und Periost-Elevatoren DE

Elevadores para el tabique nasal y para el periostia ES

46

RHINOLOGY

Hilbro



KILLIAN
46.0480.18
18.0cm

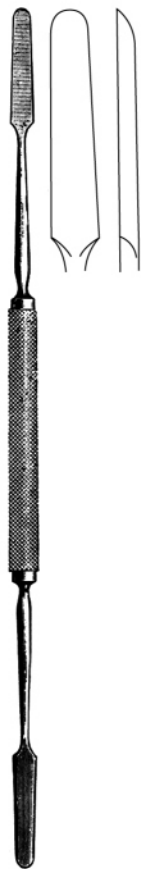

KILLIAN
46.0484.22
22.0cm



PIERCE
46.0490.21
21.0cm



PENNINGTON
46.0494.21
21.0cm



ROGER
46.0500.19
19.0cm

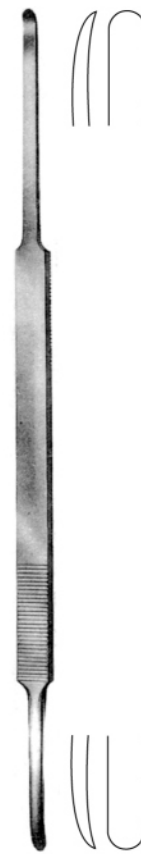

McKENTY
46.0504.22
22.0cm

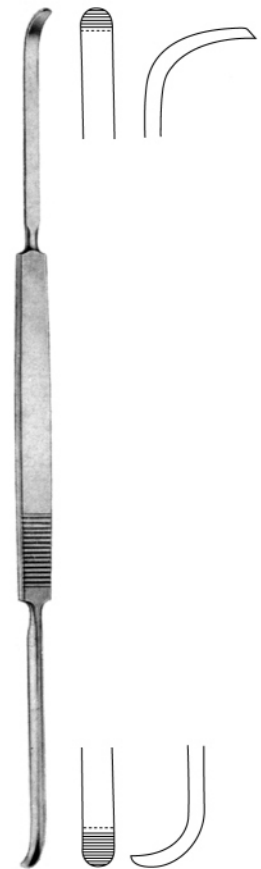

COTTLE
46.0510.23
23.0cm

46.0510.23

46-019

www.hilbro.net

EN Septum and Periosteal Elevators

DE Septum-und Periost-Elevatoren

ES Elevadores para el tabique nasal y para el periostio

RHINOLOGY

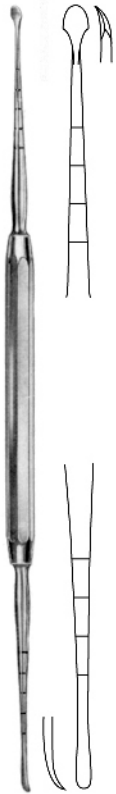

MASING
46.0514.21
21.0cm



CARTER
46.0520.21
21.0cm

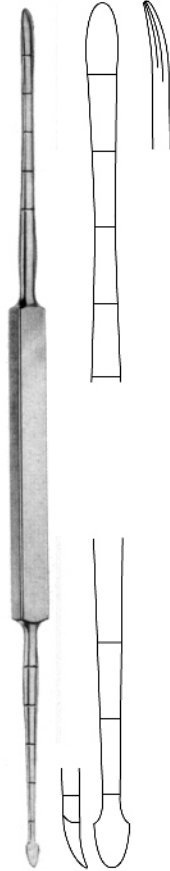

COTTLE
46.0524.21
21.0cm

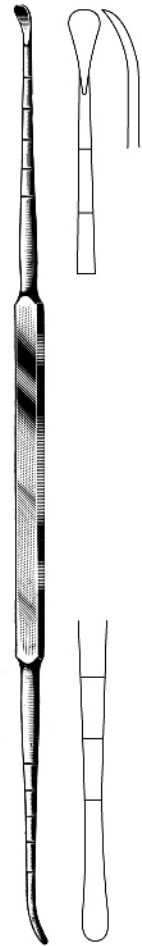

COTTLE
46.0530.22
22.0cm



JOSEPH
46.0534.16
16.0cm



COTTLE
46.0540.19
19.0cm



JOSEPH-MASING
46.0544.22
22.0cm

46.0544.22

46-020

www.hilbro.net

RHINOLOGY



KILLIAN
46.0550.17 17.0cm



KILLIAN-CLAUS
46.0554.17 17.0cm

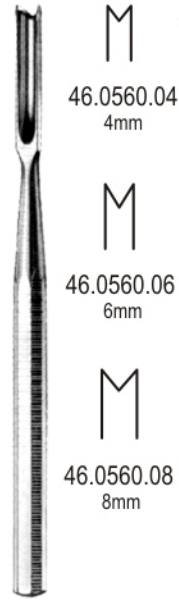

BALLENGER

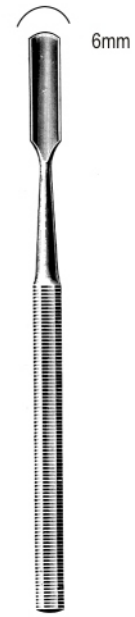

FREER
46.0564.15
15.0cm



WEST
46.0570.16 16.0cm



WEST
46.0572.16 16.0cm

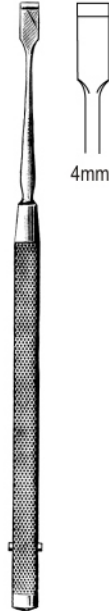

FREER
46.0580.16



FREER
46.0582.16

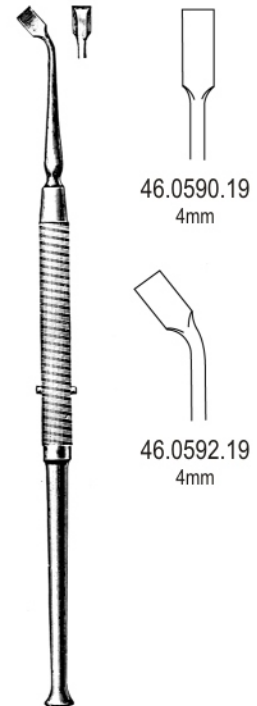

FREER

46.0592.19

46-021

www.hilbro.net

RHINOLOGY



46.0600.17

46.0602.17

JOSEPH
17.0cm

JOSEPH
19.0cm

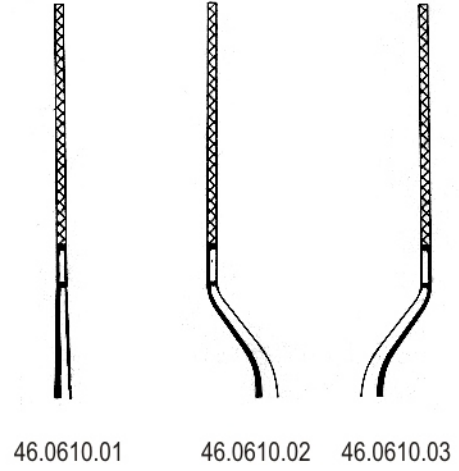

46.0610.01

46.0610.02

46.0610.03

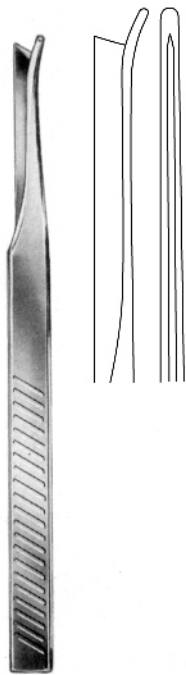

SILVER
46.0614.01 18.0cm

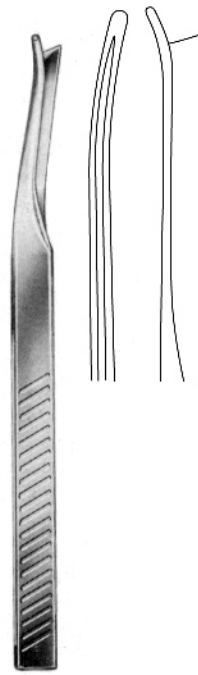

SILVER
46.0614.02 18.0cm

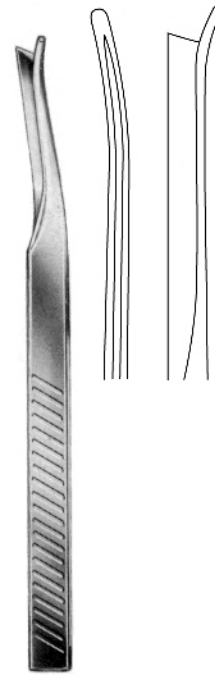

SILVER
46.0614.03 18.0cm

46.0614.03

46-022

www.hilbro.net

Osteotomes, Gouges, Chisels EN

Osteotome, Hohlimeißel, Meißel DE

Osteótomos, gubias, cinceles ES

46

RHINOLOGY

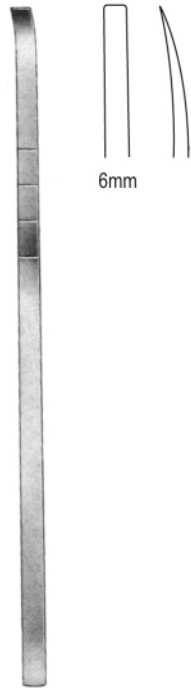

COTTLE
46.0621.18 18.0cm

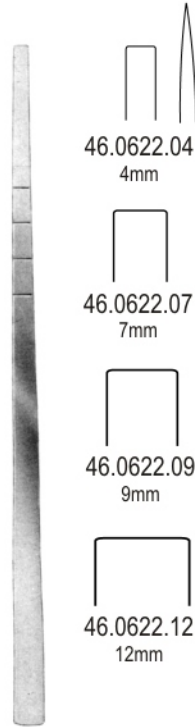

COTTLE
18.0cm



COTTLE
46.0624.18 18.0cm



COTTLE
46.0623.18 18.0cm

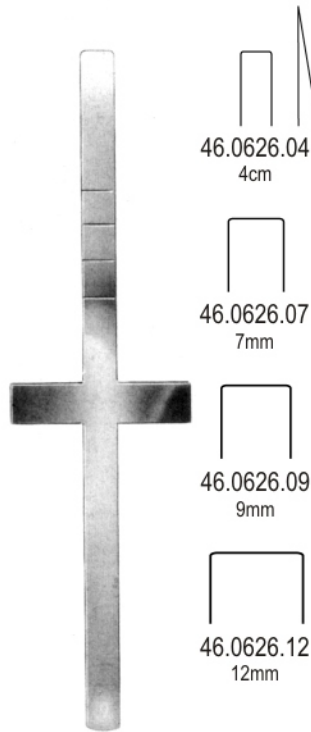

COTTLE
18.0cm

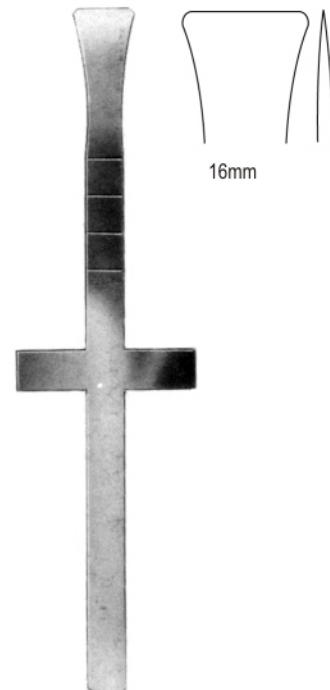

COTTLE
46.0628.18 18.0cm

46.0628.18

46-023

www.hilbro.net

EN Osteotomes, Gouges, Chisels

DE Osteotome, Hohlmeißel, Meißel

ES Osteótomos, gubias, cinceles

Hilbro

RHINOLOGY

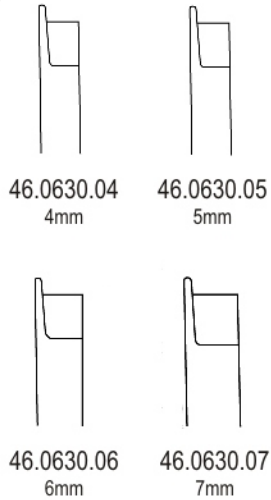

FOMON
17.0cm

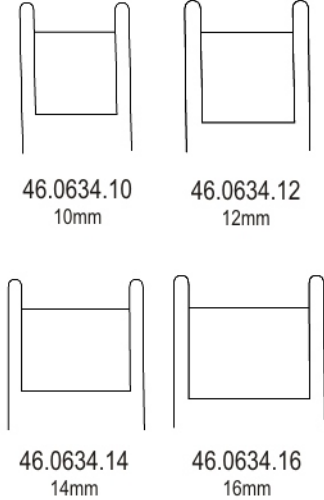

CINELLI
16.0cm

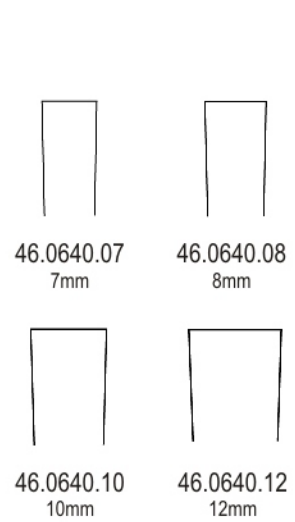

SHEEHAN
17.0cm



RUBIN
18.0cm

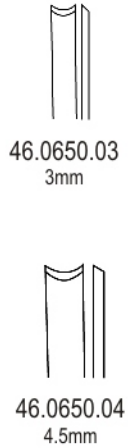

WALTER
19.0cm

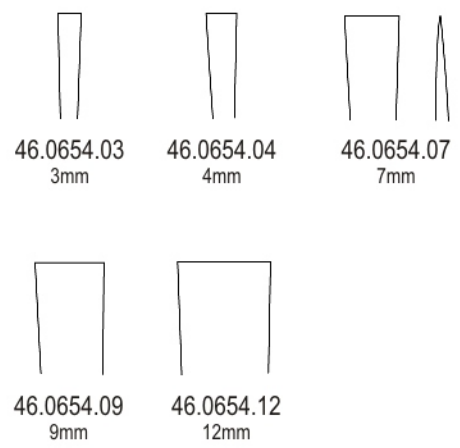

WALTER
19.0cm

46.0654.12

46-024

www.hilbro.net

RHINOLOGY

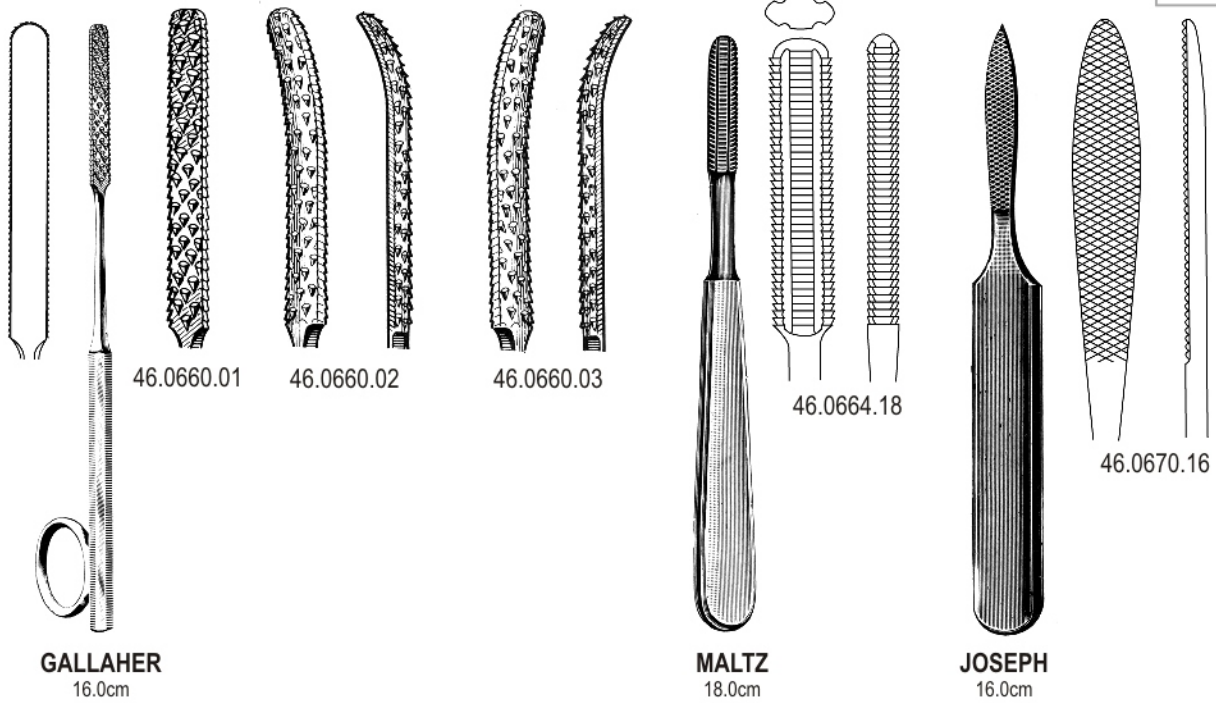

GALLAHER
16.0cm

MALTZ
18.0cm

JOSEPH
16.0cm

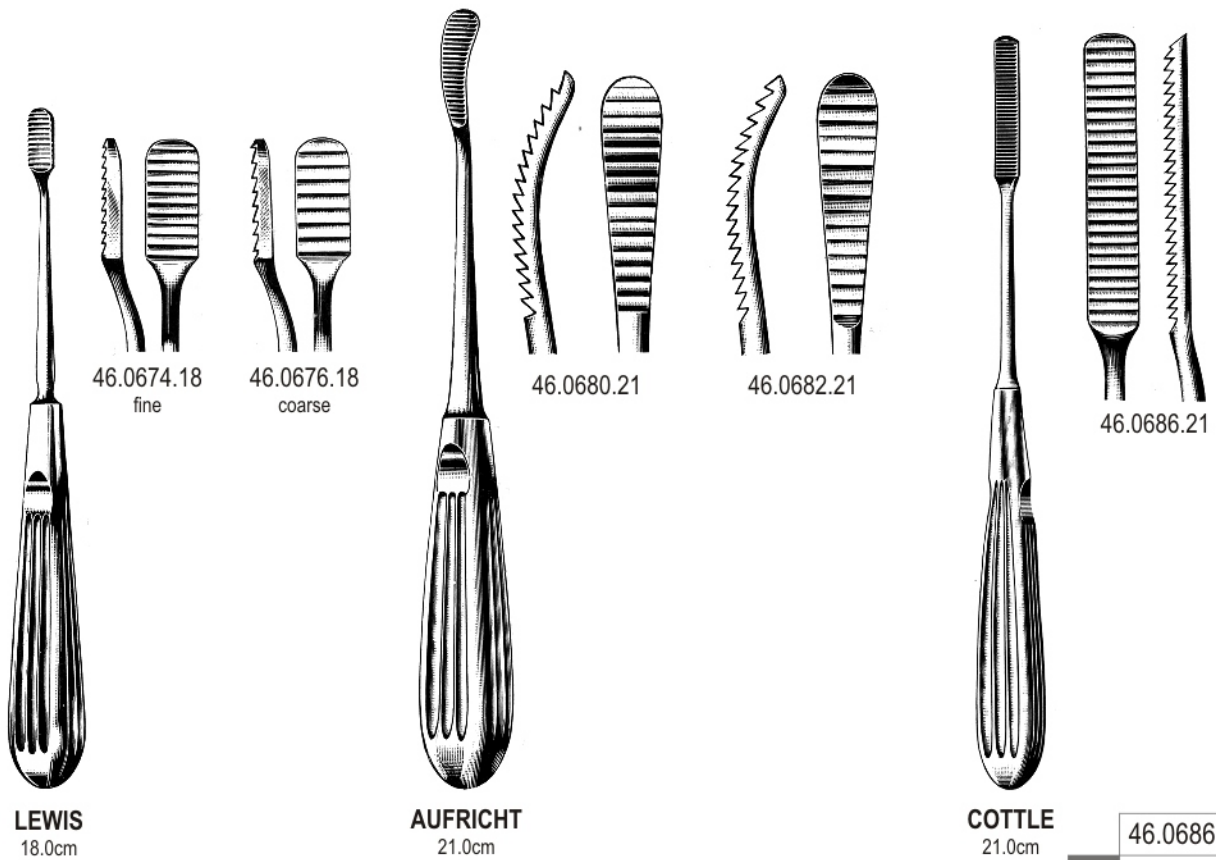

LEWIS
18.0cm

AUFRICHT
21.0cm

COTTLE
21.0cm

46.0686.21

46-025

www.hilbro.net



WIENER
18.0cm

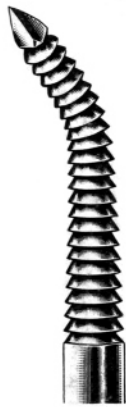

46.0690.18



46.0692.18

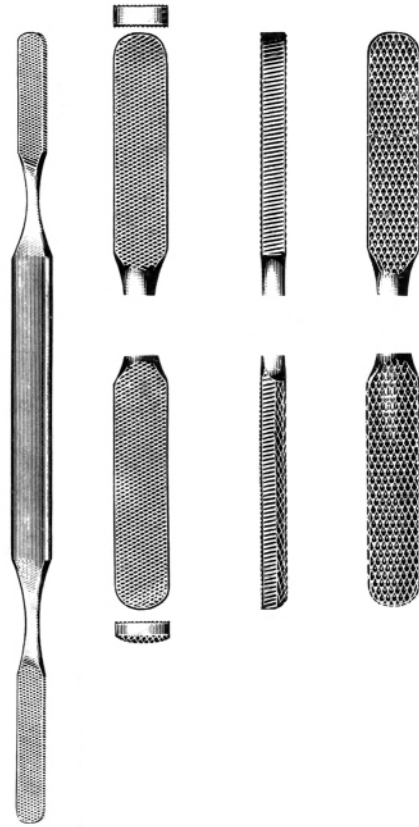

FOMON
46.0696.21 21.0cm

RHINOLOGY

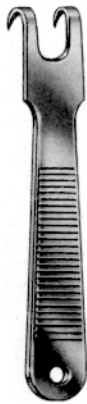

KILNER
46.0700.10 10.0cm



CONVERSE
46.0704.12 12.0cm

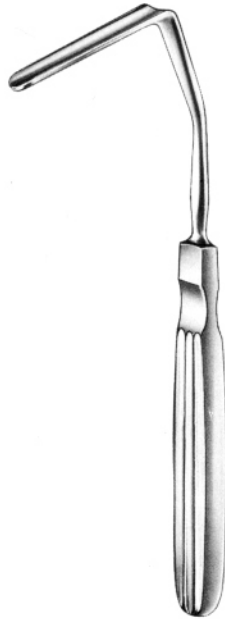

AUFRICHT
46.0710.16 16.0cm

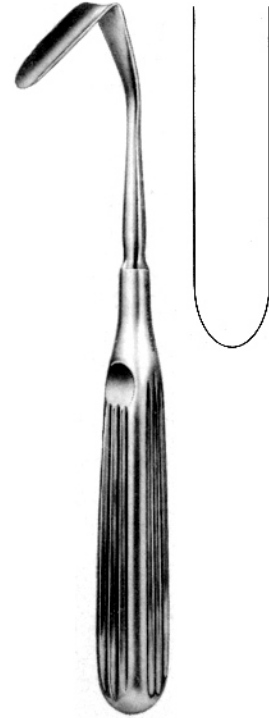

AUFRICHT
46.0712.19 19.0cm



15.0cm



46.0716.01



46.0716.02



46.0716.03



LANGE
46.0720.22 22.0cm



FOMON
46.0724.17 17.0cm



COTTLE
46.0730.16 16.0cm



FREER
46.0740.15 15.0cm

46.0740.15

46-027

www.hilbro.net

RHINOLOGY



OGURA
46.0744.11 11.0cm



COTTLE
46.0750.11 11.0cm

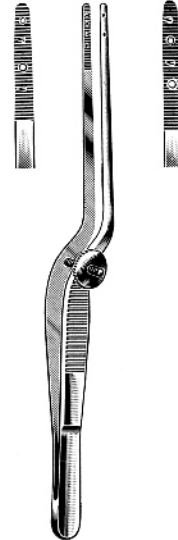

COTTLE
46.0754.14 14.0cm



COTTLE
15.0cm



46.0760.14



46.0762.01



46.0762.02



FOMON
46.0766.16 16.0cm



COTTLE-NEIVERT
46.0770.20 20.0cm

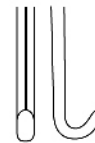

46.0770.20

46-028

www.hilbro.net

Septum Suture Needles, Nasal Retractors EN

Septumnadeln, Nasenhaken DE

Agujas para sutura del tabique nasal, separadores nasales ES

46

RHINOLOGY



YANKAUER
17.0cm



46.0774.01 46.0774.02 46.0774.03 46.0774.04 46.0774.05



46.0774.06 46.0774.07 46.0774.08 46.0774.09



COTTLE
46.0780.14 14.0cm



NEIVERT
46.0784.16 16.0cm



COTTLE
46.0800.15 15.0cm



COTTLE
46.0802.15 15.0cm



AUFRICHT
46.0806.13 13.5cm

46.0806.13

46-029

www.hilbro.net

EN Sharp Currettes

DE Scharfe Löffel und Kuretten

ES Cereetas cortantes



RHINOLOGY



COAKLEY
17.0cm

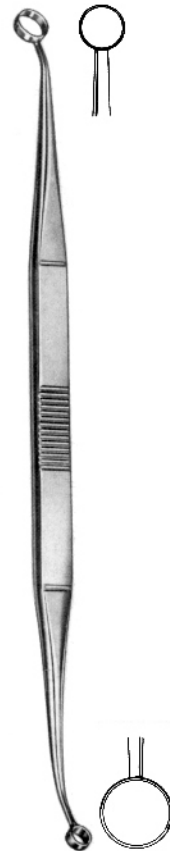
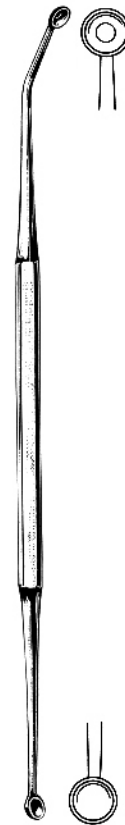
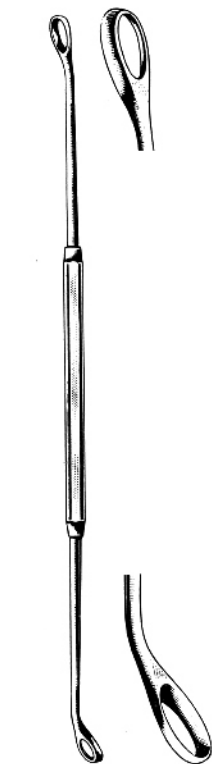

MYLES
17.0cm

PRATT
46.0824.21 21.0cm

FAULKNER
46.0826.21 21.0cm

46.0826.21

46-030

www.hilbro.net

RHINOLOGY

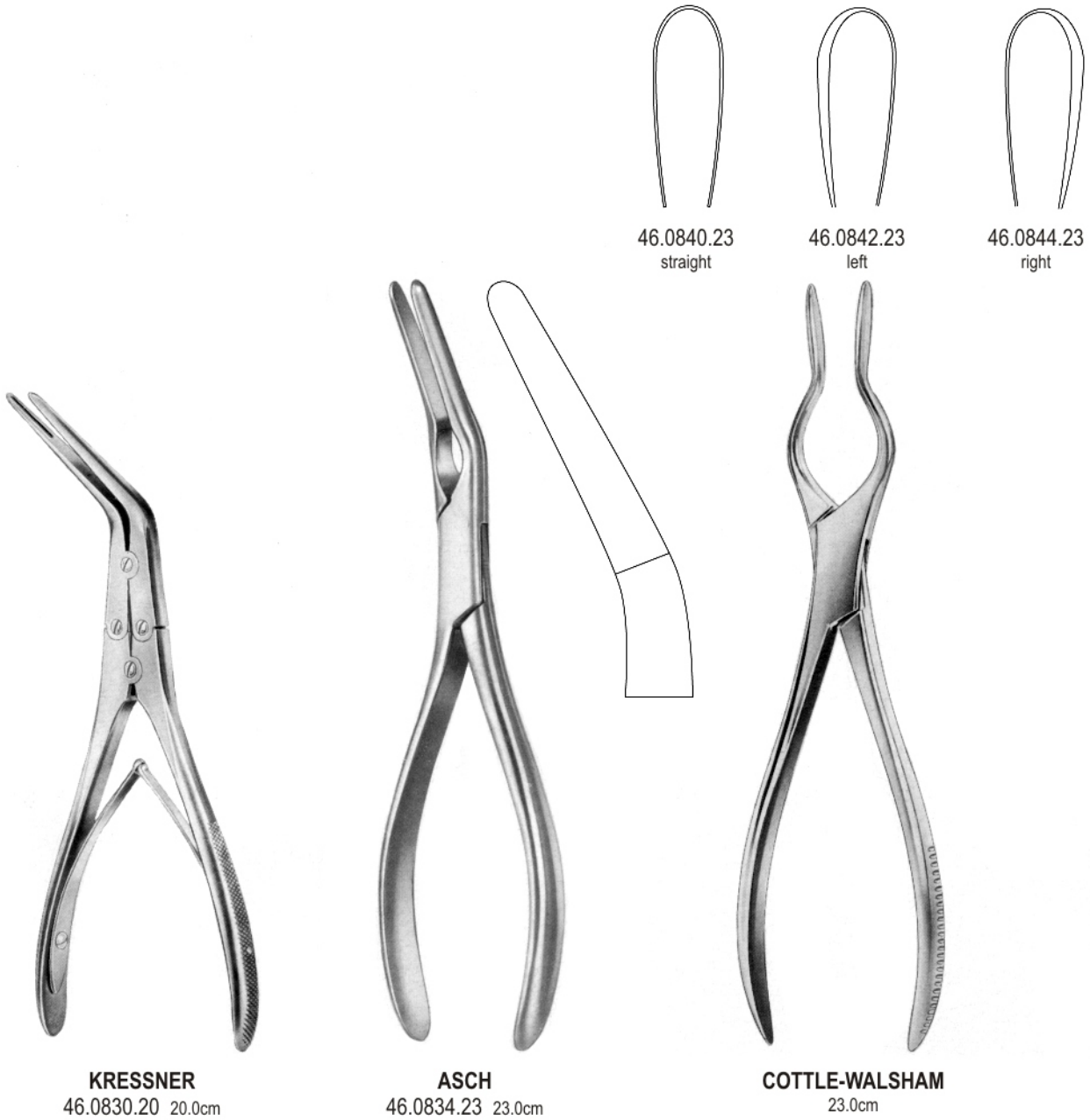

46.0844.23

46-031

www.hilbro.net

EN Adenoid Currettes

DE Ringmesser

ES Cuchillos para vegetaciones adenoides



RHINOLOGY



BECKMANN 22.0cm
46.0850.01 - 46.0850.06



BECKMANN 22.0cm
46.0852.01 - 46.0852.06



46.0850.01
46.0852.01



46.0850.02
46.0852.02



46.0850.03
46.0852.03

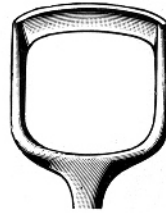

46.0850.04
46.0852.04



46.0850.05
46.0852.05

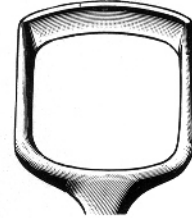

46.0850.06
46.0852.06



BECKMANN
22.0cm

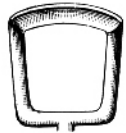

46.0856.01

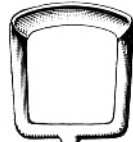

46.0856.02

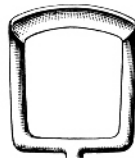

46.0856.03

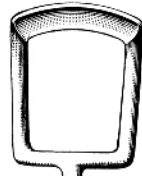

46.0856.04

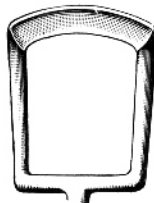

46.0856.05



ST.CLAIR-THOMSON
21.0cm



46.0860.08
8mm



46.0860.10
10mm



46.0860.12
12mm



46.0860.14
14mm

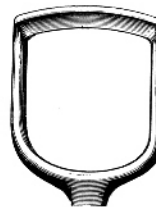

46.0860.16
16mm



46.0860.18
18mm

46.0860.18

46-032

www.hilbro.net



BRUENINGS-BRUNK
 46.0864.21 21.5cm



LA FORCE
 25.0cm



1



2

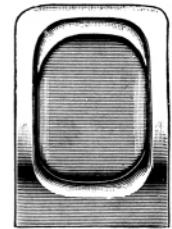

3

with unperforated blade
 46.0870.01 Fig. 1
 46.0870.02 Fig. 2
 46.0870.03 Fig. 3

spare blades
 46.0874.01 Fig. 1
 46.0874.02 Fig. 2
 46.0874.03 Fig. 3

with perforated blade
 46.0872.01
 46.0872.02
 46.0872.03

46.0876.01
 46.0876.02
 46.0876.03

EN Antrum and Frontal Sinus Wash Cannulas, Wash Catheters, Probes

DE Kiefer-und Stirnhohlen-Spulkanulen, Spulkatheter, Sonden

ES Canulas lavadoras para senos maxilar y frontal, cateteres lavadores, estiletos



RHINOLOGY



SIEBENMANN
15.0cm



- 46.0880.15 1.5mm Ø
- 46.0880.17 1.7mm Ø
- 46.0880.20 2.0mm Ø
- 46.0880.25 2.5mm Ø
- 46.0880.30 3.0mm Ø



- 46.0882.15 1.5mm Ø
- 46.0882.17 1.7mm Ø
- 46.0882.20 2.0mm Ø
- 46.0882.25 2.5mm Ø
- 46.0882.30 3.0mm Ø



GUILLEN
46.0886.20
20.0cm



RITTER-HALLE
46.0890.25 2.5mm Ø
46.0890.30 3.0mm Ø
46.0890.45 4.5mm Ø

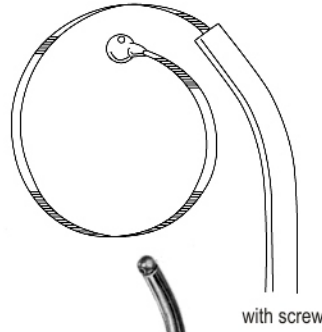

BELLOCC
46.0894.14
14.0cm

with screw



HAJEK
17.0cm
46.0900.15 1.5mm
46.0900.20 2.0mm



MYLES
46.0904.09 9.0cm
46.0904.11 11.5cm
1.8mm Ø

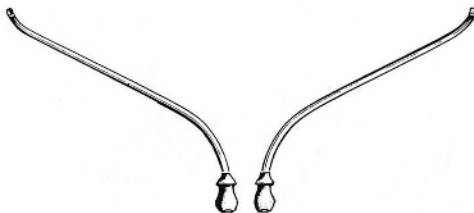

HARTMANN
46.0910.20 2.0mm 46.0912.20
46.0910.25 2.5mm 46.0912.25
46.0910.30 3.0mm 46.0912.30



HARTMANN
46.0916.20 2.0mm Ø
46.0916.25 2.5mm Ø
46.0916.30 3.0mm Ø



EICKEN-KILLIAN
46.0920.14
14.0cm, 3mm Ø



EICKEN-KILLIAN
46.0922.14
14.0cm, 3mm Ø



KILLIAN
46.0926.17
17.0cm, 1.5mm Ø

46.0926.17

46-034

www.hilbro.net